

# FORD F-150 LIGHTNING Owner's Manual



[F150LightningForum.com](https://www.F150LightningForum.com)





The information contained in this publication was correct at the time of going to print. In the interest of continuous development, we reserve the right to change specifications, design or equipment at any time without notice or obligation. No part of this publication may be reproduced, transmitted, stored in a retrieval system or translated into any language in any form by any means without our written permission. Errors and omissions excepted.

© Ford Motor Company 2022

All rights reserved.

Part Number: -202112-20220308101516

## California Proposition 65



**WARNING:** Operating, servicing and maintaining a passenger vehicle or off-highway motor vehicle can expose you to chemicals including phthalates and lead, which are known to the State of California to cause cancer and birth defects or other reproductive harm. To minimize exposure, wear gloves or wash your hands frequently when servicing your vehicle. For more information go to [www.P65Warnings.ca.gov/passenger-vehicle](http://www.P65Warnings.ca.gov/passenger-vehicle).



**WARNING:** Battery posts, terminals and related accessories contain lead and lead compounds, chemicals known to the State of California to cause cancer and reproductive harm.  
**Wash your hands after handling.**



# Table of Contents

---

## Contacting Us

Contacting Us .....19

## Introduction

About This Publication .....21

Using This Publication .....22

## Symbols Glossary

Symbols Used on Your Vehicle .....23

## Data Privacy

Data Privacy .....26

Service Data .....27

Event Data .....27

Settings Data .....28

Connected Vehicle Data .....28

Mobile Device Data .....29

Emergency Call System Data .....29

## Visual Search

Steering Wheel .....30

Instrument Panel - Vehicles With: 12.3  
Inch Screen .....31

Instrument Panel - Vehicles With: 15 Inch  
Screen .....32

Vehicle Interior .....33

Front Exterior .....34

Rear Exterior .....35

## Child Safety

Child Safety Precautions .....36

Child Restraint Anchor Points .....37

Child Restraints .....38

Installing Child Restraints .....39

Booster Seats .....44

Child Safety Locks .....46

## Seatbelts

Seatbelt Precautions .....47

Fastening and Unfastening the Seatbelts  
.....48

Sensitive Locking Mode .....49

Automatic Locking Mode .....49

Adjusting the Seatbelts During  
Pregnancy .....50

Adjusting the Seatbelt Height .....50

Adjusting the Seatbelt Length .....50

Seatbelt Reminder .....51

Checking the Seatbelts .....52

Seatbelt Extensions .....53

## Personal Safety System™

What Is the Personal Safety System  
.....54

How Does the Personal Safety System  
Work .....54

Personal Safety System Components  
.....54

## Airbags

How Do the Front Airbags Work .....55

How Do the Side Airbags Work .....55

How Do the Knee Airbags Work .....56

How Does the Safety Canopy™ Work  
.....56

Airbag Precautions .....57

Properly Adjusting the Driver and Front  
Passenger Seats .....58

Children and Airbags .....58

Front Passenger Sensing System .....59

Crash Sensors and Airbag Indicator .....62

Disposing of Airbags .....63

## Pedestrian Alert System

What Is the Pedestrian Alert System  
.....64

## 911 Assist

What Is 911 Assist .....65

How Does 911 Assist Work .....65

# Table of Contents

---

Emergency Call Requirements .....	65
Emergency Call Limitations .....	66

## Keys and Remote Controls

Remote Control Limitations .....	67
Using the Remote Control .....	67
Removing the Key Blade .....	68
Sounding the Panic Alarm .....	68
Locating Your Vehicle .....	68
Changing the Remote Control Battery .....	68
Replacing a Lost Key or Remote Control .....	69
Programming the Remote Control .....	70
Keys and Remote Controls – Troubleshooting .....	71

## Phone as a Key

What Is Phone as a Key .....	72
Phone as a Key Limitations .....	72
Programming Your Phone .....	72
Using the Valet Mode .....	73
Using the Backup Start Passcode .....	73
Phone as a Key – Troubleshooting .....	74

## MyKey™ - Vehicles With: 12.3 Inch Screen

What Is MyKey .....	76
MyKey Settings .....	76
Creating a MyKey .....	77
Programming a MyKey .....	77
Clearing All MyKeys .....	77
Checking MyKey System Status .....	78
MyKey – Troubleshooting .....	78

## MyKey™ - Vehicles With: 15 Inch Screen

What Is MyKey .....	80
MyKey Settings .....	80
Creating a MyKey .....	81

Programming a MyKey .....	81
Clearing All MyKeys .....	81
Checking MyKey System Status .....	82
MyKey – Troubleshooting .....	82

## Doors and Locks

Operating the Doors From Outside Your Vehicle .....	84
Operating the Doors From Inside Your Vehicle .....	84
Autounlock .....	85
Autolock .....	85
Mislock .....	85
Doors and Locks Audible Warnings .....	86
Doors and Locks – Troubleshooting .....	86

## Keyless Entry

Keyless Entry Limitations .....	88
Keyless Entry Settings .....	88
Using Keyless Entry .....	88

## Keyless Entry Keypad

What Is the Keyless Entry Keypad .....	89
Keyless Entry Keypad Limitations .....	89
Locating the Keyless Entry Keypad .....	89
Keyless Entry Keypad Master Access Code .....	89
Keyless Entry Keypad Personal Access Codes .....	89
Using the Keyless Entry Keypad .....	90
Keyless Entry Keypad – Troubleshooting .....	90

## Easy Entry and Exit

How Does Easy Entry and Exit Work .....	91
Switching Easy Entry and Exit On and Off .....	91

# Table of Contents

---

<b>Tailgate - Vehicles With: Manual Tailgate</b>	
Tailgate Precautions .....	92
Opening the Tailgate .....	92
Removing and Installing the Tailgate .....	92
Tailgate Step .....	93
Tailgate Work Surface .....	94

<b>Tailgate - Vehicles With: Power Tailgate</b>	
Tailgate Precautions .....	95
Opening the Tailgate .....	95
Closing the Tailgate .....	95
Removing and Installing the Tailgate .....	96
Tailgate Step .....	97
Tailgate Work Surface .....	98
Tailgate – Troubleshooting .....	99

<b>Security</b>	
Passive Anti-Theft System .....	101
Anti-Theft Alarm System .....	101
Anti-Theft Alarm System Settings .....	102
Security – Troubleshooting .....	103

<b>Power Running Boards</b>	
Power Running Board Precautions .....	105
Power Running Board Settings .....	105
Power Running Board Kick Switch .....	105
Deploying and Stowing the Power Running Boards .....	106
Power Running Boards – Troubleshooting .....	106

<b>Steering Wheel</b>	
Adjusting the Steering Wheel - Vehicles With: Manual Adjustable Steering Column .....	107

Adjusting the Steering Wheel - Vehicles With: Power Adjustable Steering Column .....	107
Resetting the Stopping Position - Vehicles With: Power Adjustable Steering Column .....	108
Horn .....	108
Switching the Heated Steering Wheel On and Off - Vehicles With: 12.3 Inch Screen .....	108
Switching the Heated Steering Wheel On and Off - Vehicles With: 15 Inch Screen .....	108

<b>Adjustable Pedals</b>	
Adjusting the Pedals .....	109

<b>Wipers and Washers</b>	
Wipers .....	110
Autowipers .....	110
Checking the Wiper Blades .....	111
Replacing the Front Wiper Blades .....	111
Washers .....	112
Wipers and Washers – Troubleshooting .....	113

<b>Exterior Lighting</b>	
Exterior Lighting Control .....	114
Headlamps .....	114
Headlamps – Troubleshooting .....	114
Autolamps .....	115
Exterior Lamps .....	115
Exterior Zone Lighting .....	117
Automatic High Beam Control .....	119
Automatic High Beam Control – Troubleshooting .....	122
Glare Free Lighting .....	122
Glare Free Lighting – Troubleshooting .....	125
Adaptive Front Lighting .....	125

# Table of Contents

---

## Interior Lighting

Switching All of the Interior Lamps On and Off .....	127
Switching the Front Interior Lamps On and Off .....	127
Switching the Rear Interior Lamps On and Off .....	127
Interior Lamp Function .....	127
Adjusting the Instrument Panel Lighting Brightness .....	128
Ambient Lighting .....	128
Cargo Lamps .....	128
Interior Lighting – Troubleshooting .....	128

## Windows

Opening and Closing the Windows .....	129
Window Bounce-Back .....	129
Locking the Rear Window Controls .....	130
Opening and Closing the Sliding Windows .....	130

## Interior Mirror

Interior Mirror Precautions .....	131
Manually Dimming the Interior Mirror .....	131
Auto-Dimming Interior Mirror .....	131

## Exterior Mirrors

Adjusting the Exterior Mirrors .....	132
Folding the Exterior Mirrors - Vehicles With: Manual Folding Mirrors .....	132
Folding the Exterior Mirrors - Vehicles With: Power Folding Mirrors .....	132
Auto-Dimming Exterior Mirror .....	133

## Moonroof

Opening and Closing the Sunshade .....	134
Opening and Closing the Moonroof .....	134
Venting the Moonroof .....	135
Moonroof Bounce-Back .....	135

## Instrument Cluster

Instrument Cluster Overview .....	136
Power Gauge .....	137
Speedometer .....	137
Vehicle Range Display .....	137
High Voltage Battery Gauge .....	137
High Voltage Battery Temperature Gauge .....	138
Electric Motor Temperature Gauge .....	138
What Are the Instrument Cluster Warning Lamps .....	138
Instrument Cluster Warning Lamps .....	138
What Are the Instrument Cluster Indicators .....	140
Instrument Cluster Indicators .....	140

## Instrument Cluster Display

Using the Instrument Cluster Display Controls .....	142
Instrument Cluster Display Main Menu .....	142
Customizing the Instrument Cluster Display .....	143
Brake Coach .....	143
Trip Summary .....	143
Vehicle Charging Status .....	143

## Personalized Settings - Vehicles With: 12.3 Inch Screen

Changing the Language .....	144
Changing the Measurement Unit .....	144
Changing the Temperature Unit .....	144
Changing the Tire Pressure Unit .....	144

## Personalized Settings - Vehicles With: 15 Inch Screen

Changing the Language .....	145
Changing the Measurement Unit .....	145
Changing the Temperature Unit .....	145



# Table of Contents

---

Changing the Tire Pressure Unit .....145

## **Trip Computer**

Accessing the Trip Computer .....146

Resetting the Trip Computer .....146

Trip Data - Vehicles With: 12.3 Inch  
Screen .....146

Trip Data - Vehicles With: 15 Inch Screen  
.....146

## **Remote Start**

What Is Remote Start .....148

Remote Start Precautions .....148

Remote Start Limitations .....148

Enabling Remote Start .....148

Remotely Starting and Stopping the  
Vehicle .....148

Extending the Remote Start Duration  
.....149

Remote Start Settings .....149

## **Climate Control - Vehicles With: 12.3 Inch Screen**

Identifying the Climate Control Unit .....150

Switching Climate Control On and Off  
.....150

Switching Recirculated Air On and Off  
.....150

Switching Air Conditioning On and Off  
.....150

Switching Defrost On and Off .....150

Switching Maximum Defrost On and Off  
.....150

Switching Maximum Cooling On and Off  
.....151

Switching the Heated Rear Window On  
and Off .....151

Setting the Blower Motor Speed .....151

Switching the Heated Mirrors On and Off  
.....151

Setting the Temperature .....151

Directing the Flow of Air .....151

Auto Mode .....152

Driver Focused Mode .....153

Climate Control Hints .....153

## **Climate Control - Vehicles With: 15 Inch Screen**

Identifying the Climate Control Unit .....155

Switching Climate Control On and Off  
.....155

Switching Recirculated Air On and Off  
.....155

Switching Air Conditioning On and Off  
.....155

Switching Defrost On and Off .....155

Switching Maximum Defrost On and Off  
.....155

Switching Maximum Cooling On and Off  
.....156

Switching the Electric Heater On and Off  
.....156

Switching the Heated Rear Window On  
and Off .....156

Setting the Blower Motor Speed .....156

Switching the Heated Mirrors On and Off  
.....157

Setting the Temperature .....157

Directing the Flow of Air .....157

Auto Mode .....157

Driver Focused Mode .....159

Climate Control Hints .....159

## **Interior Air Quality**

What Is the Cabin Air Filter .....161

Replacing the Cabin Air Filter .....161

## **Front Seats**

Front Seat Precautions .....162

Sitting in the Correct Position .....162

Manual Seats .....163

Power Seats .....165

Massage Seats .....168

# Table of Contents

Heated Seats .....	169	Garage Door Opener Additional Assistance .....	180
Ventilated Seats .....	170		
<b>Rear Seats</b>		<b>USB Ports</b>	
Manual Seats .....	171	Locating the USB Ports .....	181
Heated Seats .....	172	Playing Media Using the USB Port - Vehicles With: 12.3 Inch Screen .....	181
		Playing Media Using the USB Port - Vehicles With: 15 Inch Screen .....	182
<b>Rear Occupant Alert System</b>		Charging a Device .....	182
What is the Rear Occupant Alert System .....	174		
How Does the Rear Occupant Alert System Work .....	174	<b>Power Outlet</b>	
Rear Occupant Alert System Precautions .....	174	What Is the Power Outlet .....	183
Rear Occupant Alert System Limitations .....	174	Power Outlet Precautions .....	183
Switching Rear Occupant Alert System On and Off - Vehicles With: 12.3 Inch Screen .....	174	Locating the Power Outlets .....	183
Switching Rear Occupant Alert System On and Off - Vehicles With: 15 Inch Screen .....	175		
Rear Occupant Alert System Indicators .....	175	<b>Onboard Generator</b>	
Rear Occupant Alert System Audible Warnings .....	175	What Is the Onboard Generator .....	184
		Onboard Generator Precautions .....	184
<b>Memory Function</b>		Locating the Outlets .....	184
What Is the Memory Function .....	176	Onboard Generator Indicators .....	185
Memory Function Precautions .....	176	Switching the Outlets On and Off - Vehicles With: 12.3 Inch Screen .....	186
Locating the Memory Function Buttons .....	176	Switching the Outlets On and Off - Vehicles With: 15 Inch Screen .....	186
Saving a Preset Position .....	176	Setting the High Voltage Battery Reserve Limit .....	187
Recalling a Preset Position .....	176	Resetting Ground Fault Detection .....	187
		Resetting the Circuit Breaker - Vehicles With: 9.6kW .....	187
<b>Garage Door Opener</b>		Onboard Generator – Troubleshooting .....	188
Garage Door Opener Introduction .....	177		
Garage Door Opener Precautions and Frequencies .....	177	<b>Center Console Work Surface</b>	
Programming the Garage Door Opener .....	178	Using the Center Console Work Surface .....	190
		Center Console Work Surface – Troubleshooting .....	190

# Table of Contents

---

## Wireless Accessory Charger

What Is the Wireless Accessory Charger .....	191
Wireless Accessory Charger Precautions .....	191
Locating the Wireless Accessory Charger .....	191
Charging a Wireless Device .....	191

## Storage

Cup Holders .....	192
Glove Compartment .....	192
Glasses Holder .....	193

## Starting and Powering Off

Starting and Powering Off Precautions .....	194
Starting the Vehicle .....	194
Powering Off .....	194
Restarting the Vehicle After Powering Off .....	194
Vehicle Power Down Timer .....	195
Accessing the Passive Key Backup Position .....	195
Starting and Powering Off – Troubleshooting .....	196

## High Voltage Battery

What Is the High Voltage Battery .....	197
High Voltage Battery Precautions .....	197
Preserving Your High Voltage Battery .....	197
Recycling and Disposing of the High Voltage Battery .....	198
High Voltage Battery – Troubleshooting .....	198

## Charging Your Vehicle

What is AC Charging .....	199
What is DC Charging .....	199
Charging Your Vehicle Precautions .....	199
Charging Equipment .....	199

Locating the Charge Port .....	207
Charge Port Indicators .....	207
AC Charging .....	208
DC Charging .....	211
Setting the Charging Schedule and Preferences .....	214
Using FordPass and Charging .....	219
Charging Your Vehicle Hints .....	219
Charging Your Vehicle – Troubleshooting .....	220

## Intelligent Backup Power

What Is Intelligent Backup Power .....	222
How Does Intelligent Backup Power Work .....	222
Intelligent Backup Power Requirements .....	222
Pairing a Charge Station - Vehicles With: 12.3 Inch Screen .....	222
Pairing a Charge Station - Vehicles With: 15 Inch Screen .....	223
Intelligent Backup Power Settings - Vehicles With: 12.3 Inch Screen .....	223
Intelligent Backup Power Settings - Vehicles With: 15 Inch Screen .....	223
Transferring Power - Vehicles With: 12.3 Inch Screen .....	224
Transferring Power - Vehicles With: 15 Inch Screen .....	224
Intelligent Backup Power – Troubleshooting .....	225

## Electric Motor

Electric Motor Precautions .....	227
Selector Positions .....	227
Shifting Your Vehicle Into Gear .....	228
Temporary Neutral Mode .....	228
Automatic Return to Park (P) .....	229
Stowing the Selector Lever - Vehicles With: Console Shift .....	229

# Table of Contents

## Four-Wheel Drive

How Does Four-Wheel Drive Work .....	231
Four-Wheel Drive Precautions .....	231
Four-Wheel Drive Limitations .....	231
Four-Wheel Drive – Troubleshooting .....	231

## Electronic Locking Differential

What Is the Electronic Locking Differential .....	233
How Does the Electronic Locking Differential Work .....	233
Electronic Locking Differential Precautions .....	233
Switching the Electronic Locking Differential On and Off - 4x4 .....	234
Electronic Locking Differential Indicators .....	234
Electronic Locking Differential – Troubleshooting .....	235

## Brakes

Brake Precautions .....	236
Anti-Lock Braking System .....	236
Brake Over Accelerator .....	236
Locating the Brake Fluid Reservoir .....	236
Checking the Brake Fluid .....	236
Brake Fluid Specification .....	237
Brakes – Troubleshooting .....	237

## Electric Parking Brake

What Is the Electric Parking Brake .....	239
Applying the Electric Parking Brake .....	239
Applying the Electric Parking Brake in an Emergency .....	239
Manually Releasing the Electric Parking Brake .....	239
Automatically Releasing the Electric Parking Brake .....	239
Electric Parking Brake Audible Warning .....	240

Releasing the Electric Parking Brake if the Vehicle Battery Has Run Out of Charge .....	240
Electric Parking Brake – Troubleshooting .....	240

## Reverse Braking Assist

What Is Reverse Braking Assist .....	242
How Does Reverse Braking Assist Work .....	242
Reverse Braking Assist Precautions .....	242
Switching Reverse Braking Assist On and Off - Vehicles With: 12.3 Inch Screen .....	243
Switching Reverse Braking Assist On and Off - Vehicles With: 15 Inch Screen .....	243
Overriding Reverse Braking Assist .....	243
Reverse Braking Assist Indicators .....	243
Reverse Braking Assist – Troubleshooting .....	244

## Hill Start Assist

What Is Hill Start Assist .....	246
How Does Hill Start Assist Work .....	246
Hill Start Assist Precautions .....	246
Hill Start Assist – Troubleshooting .....	246

## Auto Hold

How Does Auto Hold Work .....	247
Switching Auto Hold On and Off - Vehicles With: 12.3 Inch Screen .....	247
Switching Auto Hold On and Off - Vehicles With: 15 Inch Screen .....	247
Using Auto Hold .....	247
Auto Hold Indicators .....	248

## Traction Control

What Is Traction Control .....	249
How Does Traction Control Work .....	249
Switching Traction Control On and Off .....	249

# Table of Contents

---

Traction Control Indicator .....	249	360 Degree Camera Guide Lines .....	264
Traction Control – Troubleshooting .....	250	360 Degree Camera Settings .....	265
<b>Stability Control</b>		<b>Active Park Assist</b>	
How Does Stability Control Work .....	251	What Is Active Park Assist .....	267
Switching Stability Control On and Off .....	252	How Does Active Park Assist Work .....	267
		Active Park Assist Precautions .....	267
		Switching Active Park Assist On and Off .....	267
<b>Steering</b>		Entering a Parallel Parking Space .....	267
Electric Power Steering .....	253	Entering a Perpendicular Parking Space .....	268
Steering – Troubleshooting .....	253	Exiting a Parking Space .....	268
		Active Park Assist – Troubleshooting .....	269
<b>Parking Aids</b>		<b>Cruise Control</b>	
Parking Aid Precautions .....	254	What Is Cruise Control .....	271
Switching Parking Aid On and Off - Vehicles With: 15 Inch Screen .....	254	Switching Cruise Control On and Off .....	271
Switching Parking Aid On and Off - Vehicles With: 12.3 Inch Screen .....	255	Setting the Cruise Control Speed .....	271
Rear Parking Aid .....	255	Canceling the Set Speed .....	272
Front Parking Aid .....	256	Resuming the Set Speed .....	272
Side Parking Aid .....	257	Cruise Control Indicators .....	272
Parking Aid Indicators - Vehicles With: 12.3 Inch Screen .....	258		
Parking Aid Indicators - Vehicles With: 15 Inch Screen .....	258	<b>Adaptive Cruise Control</b>	
Parking Aids – Troubleshooting .....	259	How Does Adaptive Cruise Control With Stop and Go Work .....	273
		Adaptive Cruise Control Precautions .....	273
		Adaptive Cruise Control Limitations .....	274
		Switching Adaptive Cruise Control On and Off .....	275
		Adaptive Cruise Control Automatic Cancellation .....	276
		Setting the Adaptive Cruise Control Speed .....	276
		Setting the Adaptive Cruise Control Gap .....	277
		Canceling the Set Speed .....	278
		Resuming the Set Speed .....	278
<b>Rear View Camera</b>			
What Is the Rear View Camera .....	260		
Rear View Camera Precautions .....	260		
Locating the Rear View Camera .....	260		
Rear View Camera Guide Lines .....	261		
Rear View Camera Settings .....	261		
<b>360 Degree Camera</b>			
What Is the 360 Degree Camera .....	263		
How Does the 360 Degree Camera Work .....	263		
360 Degree Camera Precautions .....	263		
360 Degree Camera Limitations .....	263		
Locating the 360 Degree Cameras .....	263		

# Table of Contents

Overriding the Set Speed .....	279
Adaptive Cruise Control Indicators .....	279
Switching From Adaptive Cruise Control to Cruise Control - Vehicles With: 12.3 Inch Screen .....	280
Switching From Adaptive Cruise Control to Cruise Control - Vehicles With: 15 Inch Screen .....	280
Lane Centering .....	280
Intelligent Adaptive Cruise Control .....	283
Adaptive Cruise Control – Troubleshooting .....	285

## BlueCruise

What Is BlueCruise .....	288
How Does BlueCruise Work .....	288
BlueCruise Precautions .....	288
BlueCruise Requirements .....	289
BlueCruise Limitations .....	289
BlueCruise Settings - Vehicles With: 12.3 Inch Screen .....	290
BlueCruise Settings - Vehicles With: 15 Inch Screen .....	290
Switching BlueCruise On and Off .....	290
BlueCruise Alerts .....	291
BlueCruise Automatic Cancellation .....	291
BlueCruise Indicators .....	292
BlueCruise – Troubleshooting .....	292

## Drive Mode Control

What Is Drive Mode Control .....	294
How Does Drive Mode Control Work .....	294
Selecting a Drive Mode .....	294
Drive Modes .....	294
Drive Mode Control – Troubleshooting .....	295

## One Pedal Drive

What is One Pedal Drive .....	296
One Pedal Drive Precautions .....	296

One Pedal Drive Limitations .....	296
Switching One Pedal Drive On and Off - Vehicles With: 12.3 Inch Screen .....	296
Switching One Pedal Drive On and Off - Vehicles With: 15 Inch Screen .....	296
One Pedal Drive Indicators .....	296

## Lane Keeping System

What Is the Lane Keeping System .....	297
How Does the Lane Keeping System Work .....	297
Lane Keeping System Precautions .....	297
Lane Keeping System Limitations .....	297
Switching the Lane Keeping System On and Off .....	298
Switching the Lane Keeping System Mode - Vehicles With: 12.3 Inch Screen .....	298
Switching the Lane Keeping System Mode - Vehicles With: 15 Inch Screen .....	299
Alert Mode .....	299
Aid Mode .....	299
Alert and Aid Mode .....	300
Lane Keeping System Indicators .....	300
Lane Keeping System – Troubleshooting .....	301

## Blind Spot Information System

What Is Blind Spot Information System .....	304
How Does Blind Spot Information System Work .....	304
Blind Spot Information System Precautions .....	304
Blind Spot Information System Limitations .....	304
Blind Spot Information System Requirements .....	304
Switching Blind Spot Information System On and Off - Vehicles With: 12.3 Inch Screen .....	304

# Table of Contents

---

Switching Blind Spot Information System On and Off - Vehicles With: 15 Inch Screen .....	305
Locating the Blind Spot Information System Sensors .....	305
Blind Spot Information System With Trailer Coverage .....	306
Blind Spot Information System Indicators .....	307
Blind Spot Information System – Troubleshooting .....	308
<b>Cross Traffic Alert</b>	
What Is Cross Traffic Alert .....	309
How Does Cross Traffic Alert Work .....	309
Cross Traffic Alert Precautions .....	309
Cross Traffic Alert Limitations .....	309
Switching Cross Traffic Alert On and Off - Vehicles With: 12.3 Inch Screen .....	310
Switching Cross Traffic Alert On and Off - Vehicles With: 15 Inch Screen .....	310
Locating the Cross Traffic Alert Sensors .....	310
Cross Traffic Alert Indicators .....	311
Cross Traffic Alert – Troubleshooting .....	311
<b>Pre-Collision Assist</b>	
What Is Pre-Collision Assist .....	312
How Does Pre-Collision Assist Work .....	312
Pre-Collision Assist Precautions .....	312
Pre-Collision Assist Limitations .....	313
Switching Pre-Collision Assist On and Off - Vehicles With: 12.3 Inch Screen .....	314
Switching Pre-Collision Assist On and Off - Vehicles With: 15 Inch Screen .....	314
Locating the Pre-Collision Assist Sensors .....	315
Distance Indication .....	316
Distance Alert .....	317
Automatic Emergency Braking .....	317
Evasive Steering Assist .....	318
Pre-Collision Assist – Troubleshooting .....	319
<b>Driver Alert</b>	
What Is Driver Alert .....	322
How Does Driver Alert Work .....	322
Driver Alert Precautions .....	322
Driver Alert Limitations .....	322
Switching Driver Alert On and Off - Vehicles With: 12.3 Inch Screen .....	323
Switching Driver Alert On and Off - Vehicles With: 15 Inch Screen .....	323
Driver Alert – Troubleshooting .....	323
<b>Speed Sign Recognition</b>	
What Is Speed Sign Recognition .....	324
How Does Speed Sign Recognition Work .....	324
Speed Sign Recognition Precautions .....	324
Speed Sign Recognition Limitations .....	324
Speed Sign Recognition Indicators .....	324
Setting the Speed Sign Recognition Speed Warning - Vehicles With: 12.3 Inch Screen .....	325
Setting the Speed Sign Recognition Speed Warning - Vehicles With: 15 Inch Screen .....	325
Setting the Speed Sign Recognition Speed Tolerance - Vehicles With: 12.3 Inch Screen .....	325
Setting the Speed Sign Recognition Speed Tolerance - Vehicles With: 15 Inch Screen .....	325
Speed Sign Recognition – Troubleshooting .....	326
<b>Load Carrying</b>	
Load Carrying Precautions .....	328
Using a Slide-In Camper .....	329

# Table of Contents

Locating the Safety Compliance Certification Labels .....	329
What Is the Gross Axle Weight Rating .....	329
What Is the Gross Vehicle Weight Rating .....	329
What Is the Gross Combined Weight Rating .....	329
Calculating Payload .....	331
Calculating the Load Limit .....	331

## Luggage Compartment

Luggage Compartment Precautions .....	334
Opening the Frunk .....	334
Closing the Frunk .....	336
Installing and Removing the Luggage Compartment Cover .....	338
Adjusting the Luggage Compartment Load Floor .....	340
Luggage Compartment Anchor Points .....	340
Luggage Compartment – Troubleshooting .....	340

## Pickup Bed

Pickup Bed Precautions .....	343
Pickup Bed Anchor Points .....	343
Tailgate Anchor Points .....	345
Pickup Bed Ramps .....	345

## Connecting a Trailer

Connecting a Trailer Precautions .....	348
Hitches .....	348
Connecting a Trailer .....	348
Trailer Lighting Check .....	350
Connecting a Trailer – Troubleshooting .....	351

## Towing a Trailer

Towing a Trailer Precautions .....	352
Trailer Brake Precautions .....	352

Towing a Trailer Limitations .....	353
Loading Your Trailer .....	353
Trailer Towing Hints .....	353
Launching or Retrieving a Boat or Personal Watercraft .....	354
Towing Weights and Dimensions .....	354
Towing a Trailer – Troubleshooting .....	356

## Integrated Trailer Brake Controller

What Is the Integrated Trailer Brake Controller .....	358
Integrated Trailer Brake Controller Precautions .....	358
Using the Integrated Trailer Brake Controller .....	358
Adjusting the Integrated Trailer Brake Controller Mode .....	360
Integrated Trailer Brake Controller – Troubleshooting .....	360

## Trailer Sway Control

How Does Trailer Sway Control Work .....	362
Trailer Sway Control Precautions .....	362
Switching Trailer Sway Control On and Off - Vehicles With: 12.3 Inch Screen .....	362
Switching Trailer Sway Control On and Off - Vehicles With: 15 Inch Screen .....	362

## Trailer Reversing Aid - Vehicles With: Pro Trailer Backup Assist

What Is the Trailer Reversing Aid .....	363
How Does the Trailer Reversing Aid Work .....	363
Trailer Reversing Aid Precautions .....	363
Setting Up the Trailer Reversing Aid for a Conventional Trailer .....	363
Switching the Trailer Reversing Aid On and Off .....	366



# Table of Contents

---

Using the Trailer Reversing Aid Controller .....	366	Using Smart Hitch - Vehicles With: 15 Inch Screen .....	381
Using the Trailer Reverse Guidance Views .....	367	<b>On-Board Scale</b>	
Trailer Reversing Aid - Troubleshooting .....	369	What Is On-Board Scale .....	383
<b>Trailer Reversing Aid - Vehicles With: Trailer Reverse Guidance (TRG)</b>		How Does On-Board Scale Work .....	383
What Is the Trailer Reversing Aid .....	371	On-Board Scale Limitations .....	383
How Does the Trailer Reversing Aid Work .....	371	Using On-Board Scale - Vehicles With: 12.3 Inch Screen .....	383
Trailer Reversing Aid Precautions .....	371	Using On-Board Scale - Vehicles With: 15 Inch Screen .....	384
Setting Up the Trailer Reversing Aid for a Conventional Trailer .....	371	<b>Trailer Backup Assistance</b>	
Switching the Trailer Reversing Aid On and Off .....	373	What is Trailer Backup Assistance .....	386
Using the Trailer Reverse Guidance Views .....	373	How Does Trailer Backup Assistance Work .....	386
Trailer Reversing Aid - Troubleshooting .....	375	Trailer Backup Assistance Precautions .....	386
<b>Trailer Hitching Assistance</b>		Setting Up the Trailer Backup Assistance for a Conventional Trailer .....	386
What Is Trailer Hitching Assistance .....	377	Switching Trailer Backup Assistance On and Off .....	390
How Does Trailer Hitching Assistance Work .....	377	Using the Trailer Backup Assistance Controller .....	391
Trailer Hitching Assistance Precautions .....	377	Using the Trailer Backup Assistance Views .....	391
Trailer Hitching Assistance Limitations .....	377	Trailer Backup Assistance – Troubleshooting .....	394
Switching Trailer Hitching Assistance On and Off .....	378	<b>Trailer Reverse Guidance</b>	
Using Trailer Hitching Assistance .....	378	What Is Trailer Reverse Guidance .....	401
Trailer Hitching Assistance Indicators .....	379	How Does Trailer Reverse Guidance Work .....	401
<b>Smart Hitch</b>		Trailer Reverse Guidance Precautions .....	401
What Is Smart Hitch .....	380	Setting Up Trailer Reverse Guidance for a Conventional Trailer .....	401
How Does Smart Hitch Work .....	380	Switching Trailer Reverse Guidance On and Off .....	404
Smart Hitch Limitations .....	380	Using Trailer Reverse Guidance Views .....	405
Using Smart Hitch - Vehicles With: 12.3 Inch Screen .....	380	Trailer Reverse Guidance – Troubleshooting .....	407

# Table of Contents

---

## Driving Hints

Off-Road Driving .....	413
Cold Weather Precautions .....	415
Driving on Snow and Ice .....	415
Breaking-In .....	415
Electric Vehicle .....	416
Floor Mats .....	417

## Crash and Breakdown Information

Roadside Assistance .....	418
High Voltage Battery Vehicle Precautions .....	419
Switching the Hazard Flashers On and Off .....	420
Jump Starting the Vehicle .....	420
Post-Crash Alert System .....	421
Post Impact Braking .....	422
Automatic Crash Shutoff .....	422
Recovery Towing .....	422
Transporting the Vehicle .....	423

## Towing Your Vehicle

Recreationally Towing Your Vehicle .....	425
Emergency Towing - Vehicles With: 12.3 Inch Screen .....	425
Emergency Towing - Vehicles With: 15 Inch Screen .....	425
Towing Your Vehicle – Troubleshooting .....	426

## Fuses

Fuse Precautions .....	427
Under Hood Fuse Box .....	427
Body Control Module Fuse Box .....	432
Identifying Fuse Types .....	435
Fuses – Troubleshooting .....	435

## Maintenance

Maintenance Precautions .....	436
-------------------------------	-----

Opening and Closing the Hood .....	436
Under Hood Overview .....	436
Checking the Coolant .....	437
12V Battery .....	439
12V Battery – Troubleshooting .....	439
Adjusting the Headlamps .....	440
Exterior Bulbs .....	441
Interior Bulbs .....	441

## Vehicle Care

Cleaning Products .....	442
Cleaning the Exterior .....	442
Cleaning the Interior .....	444
Repairing Minor Paint Damage .....	447
Waxing Your Vehicle .....	447

## Storing Your Vehicle

Preparing Your Vehicle for Storage .....	448
Removing Your Vehicle From Storage .....	449

## Wheel and Tire Information

Locating the Tire label .....	450
Department of Transportation Uniform Tire Quality Grades .....	450
Information on the Tire Sidewall .....	451
Glossary of Tire Terminology .....	456
Tire Replacement Requirements .....	457
Using Snow Chains .....	459

## Tire Care

Checking the Tire Pressures .....	461
Inflating the Tires .....	461
Inspecting the Tire for Wear .....	462
Inspecting the Tire for Damage .....	462
Inspecting the Wheel Valve Stems .....	463
Tire Rotation .....	463

# Table of Contents

## **Tire Pressure Monitoring System**

What Is the Tire Pressure Monitoring System .....	465
Tire Pressure Monitoring System Overview .....	465
Tire Pressure Monitoring System Precautions .....	466
Tire Pressure Monitoring System Limitations .....	466
Viewing the Tire Pressures .....	467
Resetting Tire Pressure Monitoring System .....	467
Tire Pressure Monitoring System – Troubleshooting .....	470

## **Changing a Road Wheel**

Changing a Flat Tire .....	472
Wheel Nuts .....	479

## **Capacities and Specifications**

Motorcraft Parts .....	480
Cooling System Capacity and Specification .....	480
Air Conditioning System Capacity and Specification .....	481
Washer Fluid Specification .....	482
Brake Fluid Specification .....	482

## **Vehicle Identification**

Vehicle Identification Number .....	484
-------------------------------------	-----

## **Connected Vehicle**

What Is a Connected Vehicle .....	485
Connected Vehicle Requirements .....	485
Connected Vehicle Limitations .....	485
Connecting the Vehicle to a Mobile Network .....	485
Connecting the Vehicle to a Wi-Fi Network - Vehicles With: 12.3 Inch Screen .....	486

Connecting the Vehicle to a Wi-Fi Network - Vehicles With: 15 Inch Screen .....	486
Connected Vehicle – Troubleshooting .....	486

## **Vehicle Wi-Fi Hotspot - Vehicles With: 12.3 Inch Screen**

Creating a Vehicle Wi-Fi Hotspot .....	488
Changing the Vehicle Wi-Fi Hotspot Name or Password .....	488
Vehicle Wi-Fi Hotspot – Troubleshooting .....	489

## **Vehicle Wi-Fi Hotspot - Vehicles With: 15 Inch Screen**

Creating a Vehicle Wi-Fi Hotspot .....	490
Changing the Vehicle Wi-Fi Hotspot Name or Password .....	490
Vehicle Wi-Fi Hotspot – Troubleshooting .....	491

## **Audio System - Vehicles With: 12.3 Inch Screen**

Audio System Precautions .....	492
Identifying the Audio Unit .....	492
Switching the Audio Unit On and Off .....	492
Selecting the Audio Source .....	492
Playing or Pausing the Audio Source .....	492
Adjusting the Volume .....	493
Switching Shuffle Mode On and Off .....	493
Switching Repeat Mode On and Off .....	493
Setting a Memory Preset .....	493
Muting the Audio .....	493
Adjusting the Sound Settings .....	493
Setting the Clock and Date .....	494
AM/FM Radio .....	494

# Table of Contents

---

Switching the Display On and Off .....	495
Digital Radio .....	495
Satellite Radio .....	496
Audio System – Troubleshooting .....	499

## **Audio System - Vehicles With: 15 Inch Screen**

Audio System Precautions .....	503
Switching the Audio Unit On and Off .....	503
Selecting the Audio Source .....	503
Playing or Pausing the Audio Source .....	503
Adjusting the Volume .....	503
Switching Shuffle Mode On and Off .....	503
Switching Repeat Mode On and Off .....	503
Setting a Memory Preset .....	503
Muting the Audio .....	504
Adjusting the Sound Settings .....	504
Setting the Clock and Date .....	504
AM/FM Radio .....	505
Digital Radio .....	505
Satellite Radio .....	506
Audio System – Troubleshooting .....	509

## **Center Display Overview - Vehicles With: 12.3 Inch Screen**

Center Display Precautions .....	513
Center Display Limitations .....	513
Status Bar .....	513
Feature Bar .....	514
Information On Demand Screen .....	515
Rebooting the Center Display .....	515

## **Center Display Overview - Vehicles With: 15 Inch Screen**

Center Display Precautions .....	516
----------------------------------	-----

Center Display Limitations .....	516
Status Bar .....	516
Accessing Feature Drawers .....	517
Rebooting the Center Display .....	517

## **Voice Interaction - Vehicles With: 15 Inch Screen**

What is Voice Interaction .....	518
Setting the Wake Word .....	518
Beginning a Voice Interaction .....	518
Voice Interaction Examples .....	518

## **Voice Interaction - Vehicles With: 12.3 Inch Screen**

What is Voice Interaction .....	521
Setting the Wake Word .....	521
Beginning a Voice Interaction .....	521
Voice Interaction Examples .....	521

## **Alexa Built-In**

What is Alexa Built-In .....	524
Alexa Built-In Requirements .....	524
Signing Into Your Account - Vehicles With: 12.3 Inch Screen .....	524
Signing Into Your Account - Vehicles With: 15 Inch Screen .....	524
Using Alexa Built-In .....	524
Alexa Built-In Settings - Vehicles With: 12.3 Inch Screen .....	525
Alexa Built-In Settings - Vehicles With: 15 Inch Screen .....	525

## **Phone - Vehicles With: 12.3 Inch Screen**

Phone Precautions .....	527
Connecting Your Phone .....	527
Phone Menu .....	527
Making and Receiving a Phone Call .....	529
Sending and Receiving a Text Message .....	530

# Table of Contents

---

Switching Text Message Notification On and Off .....	531
--	-----

## **Phone - Vehicles With: 15 Inch Screen**

Phone Precautions .....	532
Connecting Your Phone .....	532
Phone Menu .....	532
Making and Receiving a Phone Call .....	533
Sending and Receiving a Text Message .....	534
Switching Text Message Notification On and Off .....	535

## **Bluetooth® - Vehicles With: 12.3 Inch Screen**

Connecting a Bluetooth® Device .....	536
Playing Media Using Bluetooth® .....	536

## **Bluetooth® - Vehicles With: 15 Inch Screen**

Connecting a Bluetooth® Device .....	537
Playing Media Using Bluetooth® .....	537

## **Apps - Vehicles With: 12.3 Inch Screen**

App Precautions .....	538
App Requirements .....	538
Accessing Apps .....	538
Enabling Apps on an iOS Device .....	538
Enabling Apps on an Android Device .....	538
Switching Apple CarPlay On and Off .....	539
Switching Android Auto On and Off .....	539

## **Apps - Vehicles With: 15 Inch Screen**

App Precautions .....	540
App Requirements .....	540
Accessing Apps .....	540

Enabling Apps on an iOS Device .....	540
Enabling Apps on an Android Device .....	540
Switching Apple CarPlay On and Off .....	541
Switching Android Auto On and Off .....	541

## **Personal Profiles**

How Do Personal Profiles Work .....	542
Enabling or Disabling Personal Profiles .....	542
Creating a Personal Profile .....	543
Linking or Unlinking a Personal Profile to a Remote Control .....	543
Linking or Unlinking a Personal Profile to a Device .....	544
Personal Profile Settings .....	544

## **Navigation - Vehicles With: 12.3 Inch Screen**

Connected Navigation .....	545
Accessing Navigation .....	545
Navigation Map Updates .....	545
Adjusting the Map .....	545
Live Traffic .....	545
Setting a Destination .....	545
Waypoints .....	547
Route Guidance .....	547
Trailer Towing Navigation .....	548

## **Navigation - Vehicles With: 15 Inch Screen**

Connected Navigation .....	549
Accessing Navigation .....	549
Navigation Map Updates .....	549
Adjusting the Map .....	549
Live Traffic .....	549
Setting a Destination .....	549
Waypoints .....	551
Route Guidance .....	551
Trailer Towing Navigation .....	552

# Table of Contents

---

## **Driver Identification**

How Does Driver Identification Work .....	553
Signing In as a Driver .....	553
Driver Identification – Troubleshooting .....	553

## **Vehicle System Updates - Vehicles With: 12.3 Inch Screen**

Updating the Vehicle Systems Wirelessly .....	554
Performing a Master Reset .....	555

## **Vehicle System Updates - Vehicles With: 15 Inch Screen**

Updating the Vehicle Systems Wirelessly .....	556
Performing a Master Reset .....	557

## **Accessories**

Accessories .....	558
-------------------	-----

## **Ford Protect**

What Is Ford Protect .....	559
----------------------------	-----

## **Scheduled Maintenance**

General Maintenance Information .....	561
Normal Scheduled Maintenance .....	563

## **Customer Information**

Rollover Warning .....	565
The Better Business Bureau Auto Line Program .....	565
The Mediation and Arbitration Program .....	566
Ordering a Canadian French Owner's Manual .....	566
Reporting Safety Defects in the United States .....	567

Reporting Safety Defects in Canada .....	567
Radio Frequency Certification Labels .....	568
Perchlorate .....	597
Replacement Parts Recommendation .....	597
Mobile Communications Equipment .....	598
End User License Agreement .....	599

## **Appendices**

Electromagnetic Compatibility .....	625
-------------------------------------	-----

# Contacting Us

---

If you require assistance or clarification on policies or procedures, please contact the customer relationship center.

## United States

Ford Motor Company  
Customer Relationship Center  
PO Box 6248  
Dearborn, MI 48126  
1-800-392-3673 (FORD)  
TDD for the hearing impaired:  
7-1-1 (where offered by your telephone  
service provider)  
[www.ford.com/help/contact/](http://www.ford.com/help/contact/)

## Ford Credit - US Only

Ford Credit offers a full range of financing and lease plans to help you acquire your vehicle. If you have financed or leased your vehicle through Ford Credit, thank you for your business.

For assistance call 1-800-727-7000, or for more information about Ford Credit and access to an account manager, visit [www.ford.com/finance](http://www.ford.com/finance).

## Canada

Customer Relationship Center  
Ford Motor Company of Canada Limited  
P.O. Box 2000  
Oakville, Ontario L6J 5E4  
1-800-565-3673 (FORD)  
TDD for the hearing impaired:  
7-1-1 (where offered by your telephone  
service provider)  
[www.ford.ca](http://www.ford.ca)  
Facebook: FordServiceCA (English),  
FordServiceQC (Français)

## Australia

Ford Motor Company of Australia Pty Ltd.  
Customer Relationship Centre  
Private Mail Bag 5  
Campbellfield, Victoria, 3061  
Telephone: (13 FORD) 13 3673  
E-mail: [foacust1@ford.com](mailto:foacust1@ford.com)

## New Zealand

Ford Motor Company  
Attention: Customer Relationship Centre  
Private Bag 76912  
Manukau City 2241  
Telephone: 0800 367 369 (FORDNZ)  
E-mail: [fnzcust@ford.com](mailto:fnzcust@ford.com)

## China - Imported Vehicle

Customer Relationship Center  
Telephone: 400-690-1886  
Website: <https://www.ford.com.cn/>

## China - Chang'An Ford

Customer Relationship Center  
Telephone: 800-810-8168  
Mobile: 400-887-7766  
Website: <https://www.ford.com.cn/>

## Asia Pacific Direct Markets (APDM)

E-mail: [apemrcr@ford.com](mailto:apemrcr@ford.com)

## Caribbean, Central America and Israel

Ford Motor Company  
Ford Export Operations  
Attention: Owner Relations  
1555 Fairlane Drive  
Fairlane Business Park #3  
Allen Park, MI 48101  
Fax: (313) 390-0804  
Telephone: (313) 594-4857  
E-mail: [expcac@ford.com](mailto:expcac@ford.com)

# Contacting Us

---

## **U.S. Virgin Islands and Puerto Rico**

Ford Motor Company  
Ford Export Operations  
Attention: Owner Relations  
1555 Fairlane Drive  
Fairlane Business Park #3  
Allen Park, MI 48101  
Telephone: (800) 841-3673  
E-mail: prcac@ford.com

## **Argentina**

Telephone: 0800-888-3673

## **Brazil**

www.ford.com.br

## **North Africa**

E-mail: nafcrc@ford.com

## **South Africa**

Telephone: 0860011022  
Email: fordrcr2@ford.com

## **Sub-Saharan Africa**

E-mail: ssacrc@ford.com

## **Puerto Rico**

Ford International Business Development,  
Inc.  
P.O. Box 11957  
Caparra Heights Station  
San Juan, PR 00922-1957  
1-800-392-3673 (FORD)  
Fax: (313) 390-0804  
E-mail: prcac@ford.com  
www.ford.com.pr

## **Middle East**

Ford Middle East Customer Relationship  
Center  
P.O. Box 21740  
Dubai, United Arab Emirates  
Telephone: 80004441066  
Toll-free number for the Kingdom of Saudi  
Arabia: 8008443673  
Mobily and Zain cell phone users in Saudi  
Arabia: 800850078  
Kuwait: 22280384  
Local telephone number for Kuwait: +965  
1898900  
Fax: +971 4 3327266  
E-mail: menacac@ford.com  
www.me.ford.com

## **South Korea**

Customer Relationship Center  
Telephone: +82-02-1600-6003  
E-mail: infokr1@ford.com  
Emergency Dispatch Service call:  
080-300-3673

## **Philippines**

Telephone: 02-88669408  
Email: emailus@ford.com

## **Thailand**

Telephone: 1383  
E-mail: fordthai@ford.com

## **Vietnam**

Telephone: 1800588888  
E-mail: fordvn@ford.com



# Introduction

## ABOUT THIS PUBLICATION



**WARNING:** Driving while distracted can result in loss of vehicle control, crash and injury. We strongly recommend that you use extreme caution when using any device that may take your focus off the road. Your primary responsibility is the safe operation of your vehicle. We recommend against the use of any hand-held device while driving and encourage the use of voice-operated systems when possible. Make sure you are aware of all applicable local laws that may affect the use of electronic devices while driving.



**WARNING:** You risk death, fire, or serious injury to yourself and others if you do not follow the instruction highlighted by the warning symbol.

Thank you for choosing Ford. We recommend that you take some time to get to know your vehicle in order to benefit from greater safety and pleasure from driving it. Use this publication to familiarize yourself with the basics and then read the digital version, that is available in your vehicle. You can also view the comprehensive manual through the FordPass app and through the local Ford website.

**Note:** To download the FordPass app, visit your device's app store.

**Note:** To find the local Ford website, visit <https://corporate.ford.com/operations/locations/global-links.html>.

**Note:** Use and operate your vehicle in line with all applicable laws and regulations.

**Note:** Pass on all printed owner's information when selling this vehicle.

Our digital resources include a comprehensive digital Owner's Manual dynamically created according to the features on your vehicle by using the vehicle identification number. See **Locating the Vehicle Identification Number** (page 484). The digital Owner's Manual includes visual and full text search functions so that you can quickly locate the information you are looking for. It also includes links to a number of how-to videos created to help you understand some of the advanced technologies on your vehicle.

## Features and Options

This publication describes product features and options available throughout the range of available models, sometimes even before they are generally available. It could describe options that are not available on the vehicle you have purchased.

## Illustrations

Some of the illustrations in this publication could show features as used in different models, so they could appear different to you on your vehicle.

## Location of Components

This manual may qualify the location of a component as left-hand side or right-hand side. The side is determined when facing forward in the seat.

# Introduction

---



- A Right-hand side.
- B Left-hand side.



























## USING THIS PUBLICATION

To quickly locate information about your vehicle, use the word search within the Owner's Manual application.

# Symbols Glossary

## SYMBOLS USED ON YOUR VEHICLE

These are some of the symbols you may see on your vehicle.

	Airbag		Child seat lower anchor
	Air conditioning system		Child seat tether anchor
	Air conditioning system lubricant type		Cruise control
	Anti-lock braking system		Do not open when hot
	Avoid smoking, flames or sparks		Electric Parking brake
	Battery		Explosive gas
	Battery acid		Fan warning
	Blower motor		Fasten seatbelt
	Brake fluid - non petroleum based		Flammable
	Brake system		Front fog lamps
<b>BRAKE</b>	Brake system		Fuse compartment
	Cabin air filter		Hazard flashers
	Child safety door lock or unlock		Headlamp high beams
			Headlamps on
			Heated rear window

# Symbols Glossary



Hill descent control



Horn control



Interior luggage compartment release



Jack



Keep out of reach of children



Lighting control



Low tire pressure warning



Maintain correct fluid level



Malfunction Indicator Lamp (MIL)



Note operating instructions



Panic alarm



Parking aid



Parking lamps



Passenger airbag activated



Passenger airbag deactivated



Power steering fluid



Power windows front/rear



Power window lockout



Requires registered technician



Safety alert



See Owner's Manual



See Service Manual



Side airbag



Shield the eyes



Stability control



Stability control off



Trail control



Turn Signal



Windshield defrosting system



Windshield wiping system

# Symbols Glossary

---



Windshield wash and wipe

# Data Privacy



**WARNING:** Do not connect wireless plug-in devices to the data link connector. Unauthorized third parties could gain access to vehicle data and impair the performance of safety related systems. Only allow repair facilities that follow our service and repair instructions to connect their equipment to the data link connector.

We respect your privacy and are committed to protecting it. The information contained in this publication was correct at the time of release, but as technology rapidly changes, we recommend that you visit the local Ford website for the latest information.

Your vehicle has electronic control units that have data recording functionality and the ability to permanently or temporarily store data. This data could include information on the condition and status of your vehicle, vehicle maintenance requirements, events and malfunctions. The types of data that can be recorded are described in this section. Some of the data recorded is stored in event logs or error logs.

**Note:** *Error logs are reset following a service or repair.*

**Note:** *We may provide information in response to requests from law enforcement, other government authorities and third parties acting with lawful authority or through a legal process. Such information could be used by them in legal proceedings.*

Data recorded includes, for example:

- Operating states of system components, for example battery charge level and tire pressure.
- Vehicle and component status, for example wheel speed, deceleration, lateral acceleration and seatbelt status.

- Events or errors in essential systems, for example headlamps and brakes.
- System responses to driving situations, for example airbag deployment and stability control.
- Environmental conditions, for example temperature.

Some of this data, when used in combination with other information, for example an accident report, damage to a vehicle or eyewitness statements, could be associated with a specific person.

## Services That We Provide

If you use our services, we collect and use data, for example account information, vehicle location and driving characteristics, that could identify you. We transmit this data through a dedicated, protected connection. We only collect and use data to enable your use of our services to which you have subscribed, with your consent or where permitted by law. For additional information, see the terms and conditions of the services to which you have subscribed.

For additional information about our privacy policy, refer to the local Ford website.

## Services That Third Parties Provide

We recommend that you review the terms and conditions and data privacy information for any services equipped with your vehicle or to which you subscribe. We take no responsibility for services that third parties provide.

Where equipped, SiriusXM with 360L could use the modem. To disable, turn off the SiriusXM with 360L or Vehicle Connectivity setting. See **Enabling and Disabling the Modem** (page 485).

# Data Privacy

---

## SERVICE DATA

Service data recorders in your vehicle are capable of collecting and storing diagnostic information about your vehicle. This potentially includes information about the performance or status of various systems and modules in the vehicle, such as the high voltage battery, throttle, and steering or brake systems. In order to properly diagnose and service your vehicle, Ford Motor Company (Ford of Canada in Canada), and service and repair facilities may access or share among them vehicle diagnostic information received through a direct connection to your vehicle when diagnosing or servicing your vehicle. Additionally, Ford Motor Company (Ford of Canada, in Canada) may, where permitted by law, use vehicle diagnostic information for vehicle improvement or with other information we may have about you, for example, your contact information, to offer you products or services that may interest you. Data may be provided to our service providers such as part suppliers that may help diagnose malfunctions, and who are similarly obligated to protect data. We retain this data only as long as necessary to perform these functions or to comply with law. We may provide information where required in response to official requests to law enforcement or other government authorities or third parties acting with lawful authority or court order, and such information may be used in legal proceedings. For U.S. only (if equipped), if you choose to use connected apps and services, you consent that certain diagnostic information may also be accessed electronically by Ford Motor Company and Ford authorized service facilities, and that the diagnostic information may be used to provide services to you, personalizing your experience, troubleshoot, and to improve products and services and offer you products and services that may interest

you, where permitted by law. For Canada only, for more information, please review the Ford of Canada privacy policy at [www.ford.ca](http://www.ford.ca), including our U.S. data storage and use of service providers in other jurisdictions who may be subject to legal requirements in Canada, the United States and other countries applicable to them, for example, lawful requirements to disclose personal information to governmental authorities in those countries.

## EVENT DATA

This vehicle is equipped with an event data recorder. The main purpose of an event data recorder is to record, in certain crash or near crash-like situations, such as an airbag deployment or hitting a road obstacle; this data will assist in understanding how a vehicle's systems performed. The event data recorder is designed to record data related to vehicle dynamics and safety systems for a short period of time, typically 30 seconds or less.

The event data recorder in this vehicle is designed to record such data as:

- How various systems in your vehicle were operating.
- Whether or not the driver and passenger seatbelts were buckled/fastened.
- How far (if at all) the driver was depressing the accelerator and/or the brake pedal.
- How fast the vehicle was traveling.
- Where the driver was positioning the steering wheel.

This data can help provide a better understanding of the circumstances in which crashes and injuries occur.

# Data Privacy

**Note:** Event data recorder data is recorded by your vehicle only if a non-trivial crash situation occurs; no data is recorded by the event data recorder under normal driving conditions and no personal data or information (for example name, gender, age, and crash location) is recorded.

However, parties, such as law enforcement, could combine the event data recorder data with the type of personally identifying data routinely acquired during a crash investigation.

To read data recorded by an event data recorder, special equipment is required, and access to the vehicle or the event data recorder is needed. In addition to the vehicle manufacturer, other parties, such as law enforcement, that have such special equipment, can read the information if they have access to the vehicle or the event data recorder.

## BlueCruise Data (If Equipped)

If BlueCruise is active in certain crash or near crash-like situations, such as an airbag deployment or hitting a road obstacle, the system may record driver attentiveness, based on the direction of eyes and duration, and photographs of the driver seat area.

**Note:** No data is recorded under normal driving conditions.

## SETTINGS DATA

Your vehicle has electronic control units that have the ability to store data based on your personalized settings. The data is stored locally in the vehicle or on devices that you connect to it, for example, a USB drive or digital music player. You can delete some of this data and also choose whether to share it through the services to which you subscribe. See **Enabling and Disabling the Modem** (page 485).

## Comfort and Convenience Data

Data recorded includes, for example:

- Seat and steering wheel position.
- Climate control settings.
- Radio presets.

## Entertainment Data

Data recorded includes, for example:

- Music, videos or album art.
- Contacts and corresponding address book entries.
- Navigation destinations.

## CONNECTED VEHICLE DATA



The modem has a SIM. The modem was enabled when your vehicle was built and periodically sends messages to stay connected to the cell phone network, receive automatic software updates and send vehicle-related information to us, for example diagnostic information. These messages could include information that identifies your vehicle, the SIM and the electronic serial number of the modem. Cell phone network service providers could have access to additional information, for example cell phone network tower identification. For additional information about our privacy policy, visit [www.FordConnected.com](http://www.FordConnected.com) or refer to your local Ford website.

**Note:** The modem continues to send this information unless you disable the modem or stop the modem from sharing vehicle data by changing the modem settings. See **Connected Vehicle** (page 485).

**Note:** The service can be unavailable or interrupted for a number of reasons, for example environmental or topographical conditions and data plan coverage.

**Note:** To find out if your vehicle has a modem, visit [www.FordConnected.com](http://www.FordConnected.com).



# Data Privacy

---

## MOBILE DEVICE DATA

If you connect a mobile device to your vehicle, you can display data from your device on the touchscreen for example, music and album art. You can share your vehicle data with mobile apps on your device through the system. See **App Requirements** (page 538).

The mobile apps function operates by your connected device sending data to us in the United States. The data is encrypted and includes, for example, the vehicle identification number of your vehicle, the SYNC module serial number, odometer, enabled apps, usage statistics and debugging information. We retain it only as long as necessary to provide the service, to troubleshoot, for continuous improvement and to offer you products and services that may be of interest to you according to your preferences and where allowed by law.

If you connect a cell phone to the system, the system creates a profile that links to that cell phone. The cell phone profile enables more mobile features and efficient operation. The profile contains, for example data from your phonebook, read and unread text messages and call history, including history of calls when your cell phone was not connected to the system.

If you connect a media device, the system creates and retains a media device index of supported media content. The system also records a short diagnostic log of approximately 10 minutes of all recent system activity.

The cell phone profile, media device index and diagnostic log remain in your vehicle unless you delete them and are generally accessible only in your vehicle when you connect your cell phone or media device. If you no longer plan to use the system or your vehicle, we recommend you use the master reset function to erase the stored information. See **Performing a Master Reset** (page 555).

System data cannot be accessed without special equipment and access to your vehicle's module.

For additional information about our privacy policy, refer to the local Ford website.

**Note:** *To find out if your vehicle has connectivity technology, visit [www.FordConnected.com](http://www.FordConnected.com).*

## EMERGENCY CALL SYSTEM DATA

When the emergency call system is active, it may disclose to emergency services that your vehicle has been in a crash involving the deployment of an airbag or activation of the battery shut-off. Certain versions or updates to the emergency call system may also be capable of electronically or verbally disclosing to emergency services operators your vehicle location or other details about your vehicle or crash to assist emergency services operators to provide the most appropriate emergency services. If you do not want to disclose this information, do not activate the emergency call system.

**Note:** *You cannot deactivate emergency call systems that are required by law.*

# Visual Search

## STEERING WHEEL



- A See **Switching Cruise Control On and Off** (page 271). See **Switching Adaptive Cruise Control On and Off** (page 275).
- B See **Using the Instrument Cluster Display Controls** (page 142).
- C See **Selecting a Radio Station** (page 494). See **Selecting a Radio Station** (page 505).
- D See **Making and Receiving a Phone Call** (page 529). See **Making and Receiving a Phone Call** (page 533).
- E See **What is Voice Interaction** (page 518). See **What is Voice Interaction** (page 521).
- F See **Adjusting the Volume** (page 493). See **Adjusting the Volume** (page 503).

# Visual Search

## INSTRUMENT PANEL - VEHICLES WITH: 12.3 INCH SCREEN

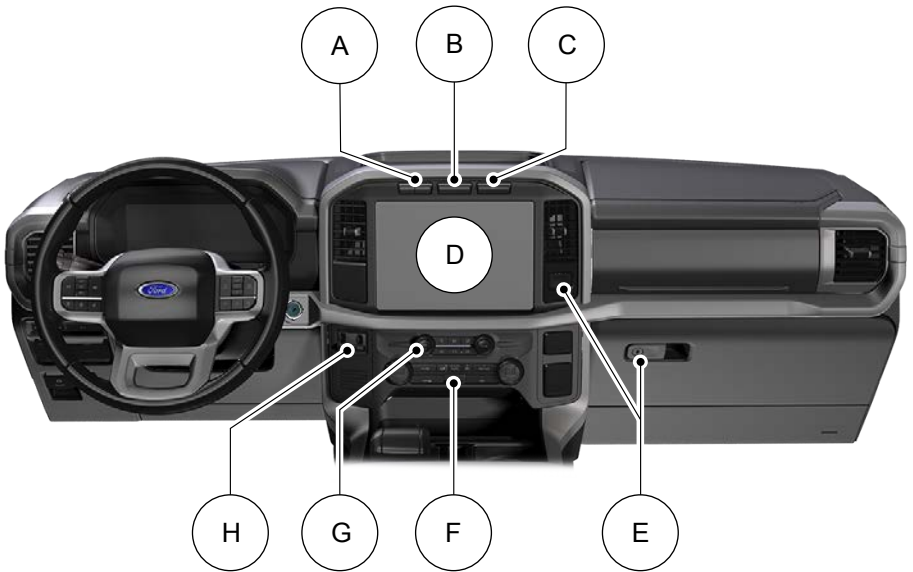

- A See **Switching the 360 Degree Camera On and Off** (page 265).
- B See **Switching the Hazard Flashers On and Off** (page 420).
- C See **Switching Traction Control On and Off** (page 249).
- D See **Feature Bar** (page 514).
- E See **Opening the Glove Compartment** (page 192).
- F See **Identifying the Climate Control Unit** (page 150).
- G See **Switching the Audio Unit On and Off** (page 492).
- H See **Using the Integrated Trailer Brake Controller** (page 358).

# Visual Search

## INSTRUMENT PANEL - VEHICLES WITH: 15 INCH SCREEN

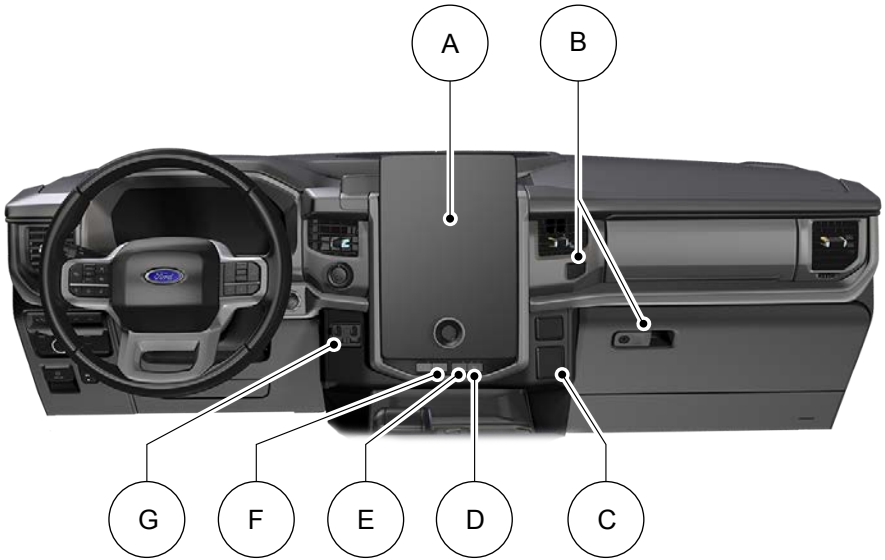

- A See **Status Bar** (page 516).
- B See **Opening the Glove Compartment** (page 192).
- C See **Locating the Power Outlets** (page 183).
- D See **Switching Traction Control On and Off** (page 249).
- E See **What is the Rear Parking Aid** (page 255).
- F See **Switching the Hazard Flashers On and Off** (page 420).
- G See **Using the Integrated Trailer Brake Controller** (page 358).

# Visual Search

## VEHICLE INTERIOR

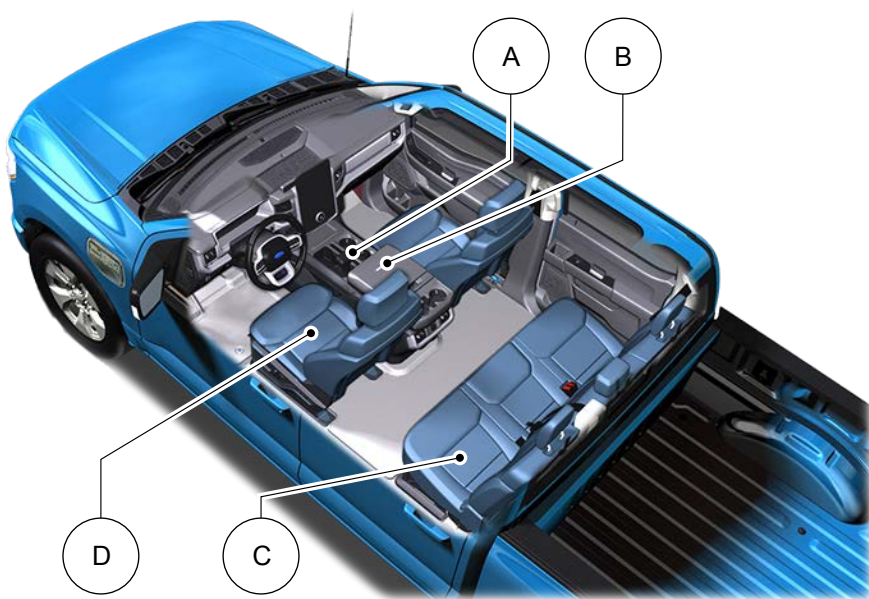

- A See **Shifting Your Vehicle Into Gear** (page 228).
- B See **Using the Center Console Work Surface** (page 190).
- C See **Folding the Seats** (page 171).
- D See **Sitting in the Correct Position** (page 162).

# Visual Search

## FRONT EXTERIOR

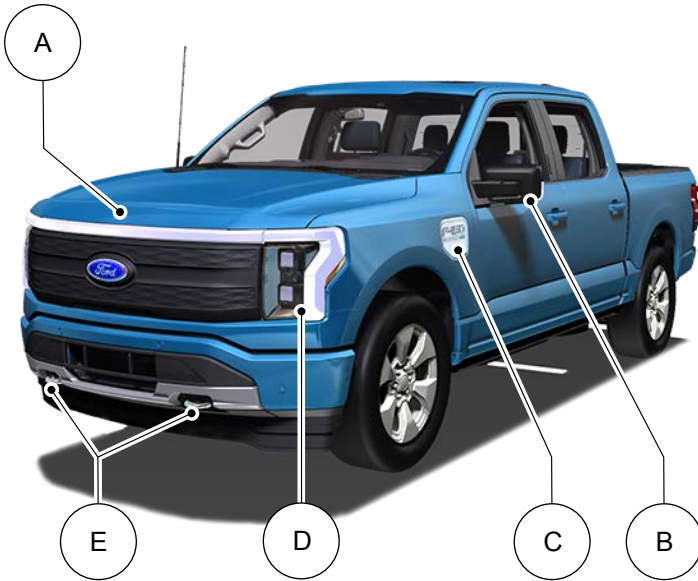

- A See **Opening the Frunk from Inside Your Vehicle** (page 334).
- B See **Folding the Exterior Mirrors** (page 132). See **Folding the Exterior Mirrors** (page 132).
- C See **Locating the Charge Port** (page 207).
- D See **Exterior Lighting Control** (page 114).
- E See **Accessing the Front Towing Point** (page 422).

# Visual Search

## REAR EXTERIOR

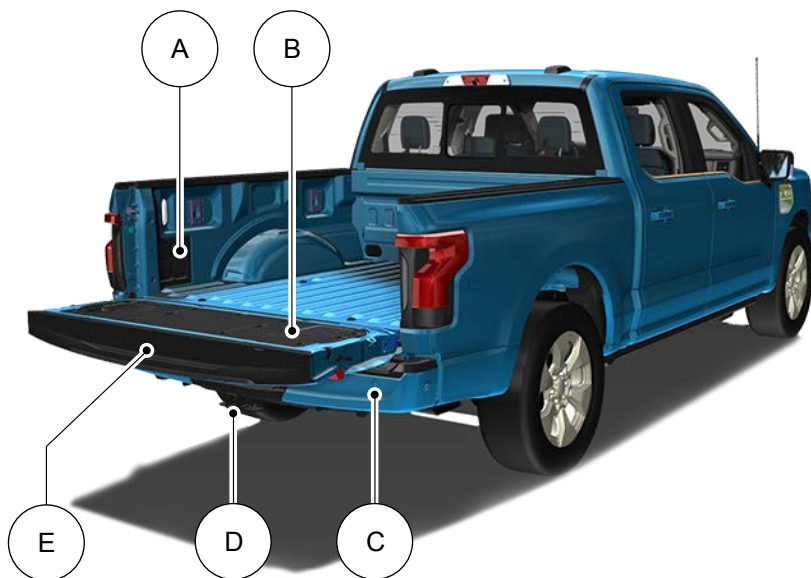

- A See **Locating the Outlets** (page 184).
- B See **Removing and Installing the Tailgate** (page 92). See **Removing and Installing the Tailgate** (page 96).
- C See **Locating the Rear Parking Aid Sensors** (page 255).
- D See **Connecting a Trailer** (page 348).
- E See **Opening the Tailgate From Outside Your Vehicle** (page 92). See **Opening the Tailgate From Inside Your Vehicle** (page 95).

# Child Safety

## CHILD SAFETY PRECAUTIONS



**WARNING:** Always make sure your child is secured properly in a device that is appropriate for their height, age and weight. Child safety restraints must be bought separately from your vehicle. Failure to follow these instructions and guidelines may result in an increased risk of serious injury or death to your child.



**WARNING:** All children are shaped differently. The National Highway Traffic Safety Administration and other safety organizations, base their recommendations for child restraints on probable child height, age and weight thresholds, or on the minimum requirements of the law. We recommend that you check with a NHTSA Certified Child Passenger Safety Technician (CPST) to make sure that you properly install the child restraint in your vehicle and that you consult your pediatrician to make sure you have a child restraint appropriate for your child. To locate a child restraint fitting station and CPST, contact NHTSA toll free at 1-888-327-4236 or go to [www.nhtsa.dot.gov](http://www.nhtsa.dot.gov). In Canada, contact Transport Canada toll free at 1-800-333-0371 or go to [www.tc.gc.ca](http://www.tc.gc.ca) to find a Child Car Seat Clinic in your area. Failure to properly restrain children in child restraints made especially for their height, age and weight, may result in an increased risk of serious injury or death to your child.



**WARNING:** On hot days, the temperature inside the vehicle can rise very quickly. Exposure of people or animals to these high temperatures for even a short time can cause death or serious heat related injuries, including brain damage. Small children are particularly at risk.



**WARNING:** Do not place a rearward facing child restraint in front of an active airbag. Failure to follow this instruction could result in personal injury or death.



**WARNING:** Properly secure children 12 years old and under in a rear seating position whenever possible. If you are unable to properly secure all children in a rear seating position, properly secure the largest child on the front seat. If you must use a forward facing child restraint on the front seat, move the seat as far back as possible. Failure to follow these instructions could result in personal injury or death.



**WARNING:** Always carefully follow the instructions and warnings provided by the manufacturer of any child restraint to determine if the restraint device is appropriate for your child's size, height, weight, or age. Follow the child restraint manufacturer's instructions and warnings provided for installation and use in conjunction with the instructions and warnings provided by your vehicle manufacturer. A safety seat that is improperly installed or utilized, is inappropriate for your child's height, age, or weight or does not properly fit the child may increase the risk of serious injury or death.



# Child Safety

**WARNING:** Do not allow a passenger to hold a child on their lap when your vehicle is moving. Failure to follow this instruction could result in personal injury or death in the event of a sudden stop or crash.

**WARNING:** Do not use pillows, books or towels to boost your child's height. Failure to follow this instruction could result in personal injury or death.

**WARNING:** Properly secure child restraints or booster seats when they are not in use. They could become projectiles in a sudden stop or crash. Failure to follow this instruction could result in personal injury or death.

**WARNING:** Do not put the shoulder section of the seatbelt or allow the child to put the shoulder section of the seatbelt under their arm or behind their back. Failure to follow this instruction could reduce the effectiveness of the seatbelt and increase the risk of injury or death in a crash.

**WARNING:** Do not leave children or pets unattended in your vehicle. Failure to follow this instruction could result in personal injury or death.

When installing a child restraint with seatbelts:

- Place the vehicle seat in the upright position before you install the child restraint.
- Use the correct seatbelt buckle for that seating position.
- Insert the belt tongue into the buckle. Make sure the tongue is securely fastened in the buckle.

- Keep the buckle release button pointing up and away from the child restraint, with the tongue between the child restraint and the release button, to prevent accidental unbuckling.
- Put the seatbelt in the automatic locking mode.

## CHILD RESTRAINT ANCHOR POINTS

### WHAT ARE THE CHILD RESTRAINT ANCHOR POINTS

Anchor points allow you to quickly and safely install a child restraint.

### LOCATING THE CHILD RESTRAINT LOWER ANCHOR POINTS

Crew Cab

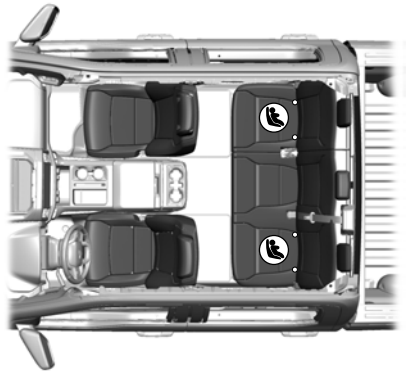

# Child Safety

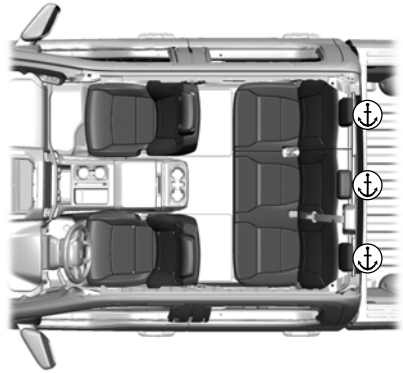
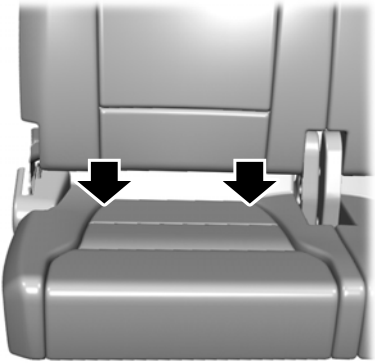

The lower child restraint anchors are at the rear section of the rear seat between the cushion and seat backrest.

## CHILD RESTRAINTS

### LOCATING THE CHILD RESTRAINT TOP TETHER ANCHOR POINTS

Crew Cab

### CHILD RESTRAINT POSITION INFORMATION

Install the child restraint tightly against the vehicle seat. It may be necessary to lift or remove the head restraint.

### Rear Facing Child Restraints

Combined Weight of Child and Child Restraint	LATCH (Lower Anchors Only)	Seatbelt Only
Up to 65 lb (29 kg)	<b>X</b>	<b>X</b>
Over 65 lb (29 kg)		<b>X</b>

### Forward Facing Child Restraints

Combined Weight of Child and Child Restraint	LATCH (Lower Anchors and Top Tether Anchor)	Seatbelt and Top Tether Anchor	Seatbelt and LATCH (Lower Anchors and Top Tether Anchor)
Up to 65 lb (29 kg)	<b>X</b>	<b>X</b>	<b>X</b>
Over 65 lb (29 kg)		<b>X</b>	<b>X</b>

# Child Safety

## CHILD RESTRAINTS RECOMMENDATION

Child Size, Height, Weight, or Age	Recommended Restraint Type
Children weighing 40 lb (18 kg) or less (generally age four or younger).	Use a child restraint (sometimes called an infant carrier, convertible seat, or toddler seat).
Children who have outgrown or no longer properly fit in a child restraint (generally children who are less than 57 in (1.45 m) tall, are greater than age four and less than age 12, and between 40 lb (18 kg) and 80 lb (36 kg) and upward to 100 lb (45 kg) if recommended by your child restraint manufacturer).	Use a belt-positioning booster seat.
Children who have outgrown or no longer properly fit in a belt-positioning booster seat (generally children who are at least 57 in (1.45 m) tall or greater than 80 lb (36 kg) or 100 lb (45 kg) if recommended by child restraint manufacturer).	Use a vehicle seatbelt having the lap belt snug and low across the hips, shoulder belt centered across the shoulder and chest, and seat backrest upright.

You are required by law to properly use child restraints for infants and toddlers in the United States, Canada and Mexico.

Many states and provinces require that small children use approved booster seats until they reach age eight, a height of 57 in (1.45 m) tall, or 80 lb (36 kg). Check your local and state or provincial laws for specific requirements about the safety of children in your vehicle.

When possible, properly restrain children 12 years of age and under in a rear seating position of your vehicle. Accident statistics suggest that children are safer when properly restrained in the rear seating positions than in a front seating position.

When installing a rear facing child restraint, adjust the vehicle seats to avoid interference between the child restraint and the vehicle seat in front of the child restraint.

## INSTALLING CHILD RESTRAINTS

### USING SEATBELTS



**WARNING:** Depending on where you secure a child restraint, and depending on the child restraint design, you may block access to certain seatbelt buckle assemblies and LATCH lower anchors, rendering those features potentially unusable. To avoid risk of injury, make sure occupants only use seating positions where they are able to be properly restrained.

**Note:** *Although the child restraint illustrated is a forward facing child restraint, the steps are the same for installing a rear facing child restraint.*

Perform the following steps when installing a child restraint with seatbelts.

# Child Safety

1. Position the child restraint in a seat with a seatbelt.



2. Pull down on the shoulder belt and then grasp the shoulder belt and lap belt together.



3. While holding the shoulder and lap belt portions together, route the tongue through the child restraint according to the child restraint manufacturer's instructions. Make sure you did not twist the belt webbing.

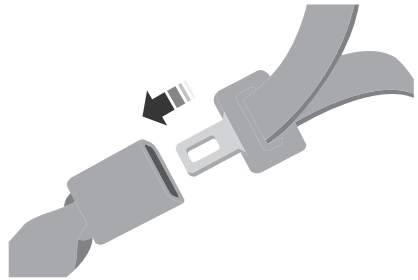

4. Insert the belt tongue into the proper buckle for that seating position until the latch engages. Make sure the tongue is latched securely by pulling on it.



5. To put the retractor in the automatic locking mode, grasp the shoulder portion of the belt and pull downward until you pull all of the seatbelt out.

**Note:** *The automatic locking mode is available on the front passenger and rear seats. This vehicle does not require the use of a locking clip.*

6. Allow the belt to retract to remove slack. The seatbelt clicks as it retracts to indicate it is in the automatic locking mode.

# Child Safety

- Pull the seatbelt out of the retractor to make sure the retractor is in the automatic locking mode. You should not be able to pull more belt out. If the retractor is not locked, unbuckle the belt and repeat Steps 5 and 6.



- Remove remaining slack from the belt. Force the seat down with extra weight, for example, by pressing down or kneeling on the child restraint while pulling up on the shoulder belt in order to force slack from the belt. This is necessary to remove the remaining slack that exists once you add the extra weight of the child to the child restraint. It also helps to achieve the proper snugness of the child restraint to your vehicle. Sometimes, a slight lean toward the buckle helps to remove remaining slack from the belt.
- If the child restraint has a tether strap, attach it.

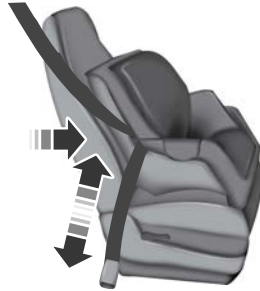

- Before placing the child in the seat, forcibly move the seat forward and back to make sure the seat is securely held in place.

To check this, grab the seat at the belt path and attempt to move it side to side and forward and back. There should be no more than 1 in (2.5 cm) of movement.

We recommend checking with a NHTSA Certified Child Passenger Safety Technician to make certain the child restraint is properly installed. In Canada, check with Transport Canada for referral to a Child Car Seat Clinic.

## USING LOWER ANCHORS AND TETHERS FOR CHILDREN



**WARNING:** Do not attach two child safety restraints to the same anchor. In a crash, one anchor may not be strong enough to hold two child safety restraint attachments and may break, causing serious injury or death.

# Child Safety



**WARNING:** Depending on where you secure a child restraint, and depending on the child restraint design, you may block access to certain seatbelt buckle assemblies and LATCH lower anchors, rendering those features potentially unusable. To avoid risk of injury, make sure occupants only use seating positions where they are able to be properly restrained.

The Lower Anchors and Tethers for Children (LATCH) system has three vehicle anchor points:

- Two lower anchors where the vehicle seat backrest and seat cushion meet, called the seat bight.
- One top tether anchor behind that seating position.

LATCH compatible child restraints have two rigid or webbing mounted attachments. These attachments connect to the two lower anchors at the LATCH equipped seating positions in your vehicle. This type of attachment method eliminates the need to use seatbelts to attach the child restraint.

However, you can still use the seatbelt to attach the child restraint if the lower anchors are not used. For forward-facing child restraints, you must also attach the top tether strap to the proper top tether anchor if a top tether strap has been provided with your child restraint.

Follow the instructions later in this chapter on attaching child restraints with tether straps.

## INSTALLING A CHILD RESTRAINT IN A CENTER SEAT



**WARNING:** The standardized spacing for LATCH lower anchors is 11 in (280 mm) center to center. Do not use LATCH lower anchors for the center seating position unless the child restraint manufacturer's instructions permit and specify using anchors spaced at least as far apart as those in this vehicle.

The lower anchors at the center of the second row rear seat are spaced 25.7 in (652 mm) apart. The standardized spacing for LATCH lower anchors is 11 in (280 mm) center to center.

You cannot install a child restraint with rigid LATCH attachments at the center seating position. You can only use LATCH compatible child restraints with attachments on belt webbing at this seating position provided that the child restraint manufacturer's instructions permit use with the anchor spacing stated. Do not attach a child restraint to any lower anchor if another child restraint is attached to that anchor.

Each time you use the child restraint, check that the seat is properly attached to the lower anchors and tether anchor, if applicable. Tug the child restraint from side to side and forward and back where it is secured to the vehicle. The seat should move less than 1 in (2.5 cm).

If you did not properly anchor the child restraint, the risk of a child being injured in a crash greatly increases.

# Child Safety

## COMBINING THE SEATBELT AND LOWER ANCHORS FOR ATTACHING CHILD RESTRAINTS

When used in combination, you may attach either the seatbelt or the LATCH lower anchors first, provided a proper installation is achieved. Attach the tether strap afterward, if it is included with the child restraint.

## USING TETHER STRAPS

Many forward-facing child restraints include a tether strap which extends from the back of the child restraint and hooks to an anchoring point called the top tether anchor. Tether straps are available as an accessory for many older child restraints.

Contact the manufacturer of your child restraint for information about ordering a tether strap, or to obtain a longer tether strap if the tether strap on your child restraint does not reach the appropriate top tether anchor in the vehicle.

Attach the tether strap only to the appropriate tether anchor. The tether strap may not work properly if attached somewhere other than the correct tether anchor.

If you install a child restraint with rigid LATCH attachments, do not tighten the tether strap enough to lift the child restraint off the vehicle seat cushion when the child is seated in it. Keep the tether strap just snug without lifting the front of the child restraint. Keeping the child restraint just touching the vehicle seat gives the best protection in a severe crash.

Once you have installed the child restraint using either the seatbelt, the lower anchors of the LATCH system, or both, you can attach the top tether strap.

## ATTACHING THE REAR SEAT TETHER STRAP

Crew Cab

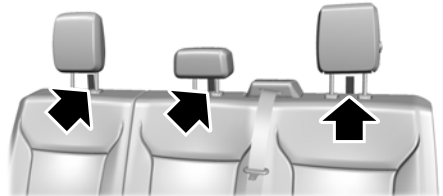

There are three loops of webbing above the back of the rear seat. Use these loops as routing loops and anchor loops for up to three child restraint tether straps.

For example, you can use the center loop as a routing loop for a child restraint in the center rear seat and as an anchoring loop for child restraints installed in the outermost rear seats.

Many tether straps cannot be tightened if the tether strap is hooked to the loop directly behind the child restraint.

To provide a tight tether strap:

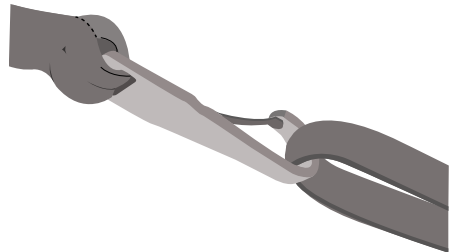

# Child Safety

1. Route the vehicle tether loop between the head restraint posts, then route the child restraint tether strap through the loop, forward of the head restraint.
2. Hook the strap to the vehicle tether anchor loop in the adjacent seating position. If using the driver side, pass the strap behind the shoulder belt for the center seat. Put the tether strap through the routing loop. The head restraint support post holds the child restraint tightly, but the head restraint post is not strong enough to hold the child restraint during a crash.
3. Tighten the tether strap according to the child restraint manufacturer's instructions.

If you did not properly anchor the child restraint, the risk of a child being injured in a crash greatly increases.

If your child restraint system has a tether strap, and the child restraint manufacturer recommends its use, we also recommend its use.

## BOOSTER SEATS

Use a belt-positioning booster seat for children who have outgrown or no longer properly fit in a child restraint and meet the following criteria.

- Generally children who are less than 57 in (1.45 m) tall.
- Are greater than age four (4) and less than age twelve (12).
- Are between 40 lb (18 kg) and 80 lb (36 kg) and upward to 100 lb (45 kg).

Many state and provincial laws require that children use approved booster seats until they reach age eight, a height of 57 in (1.45 m) tall, or 80 lb (36 kg).

Booster seats should be used until you can answer yes to all of these questions when seated without a booster seat:

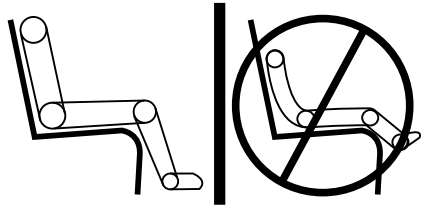

- Can the child sit all the way back against their vehicle seat backrest with knees bent comfortably at the edge of the seat cushion?
- Can the child sit without slouching?
- Does the lap belt rest low across the hips?
- Is the shoulder belt centered on the shoulder and chest?
- Can the child stay seated like this for the whole trip?

Always use booster seats in conjunction with your vehicle lap and shoulder belt.

## Types of Booster Seats



- Backless booster seats

If your backless booster seat has a removable shield, remove the shield.



# Child Safety

If a vehicle seating position has a low seat backrest or no head restraint, a backless booster seat may place your child's head, as measured at the tops of the ears, above the top of the seat. In this case, move the backless booster to another seating position with a higher seat backrest or head restraint and lap and shoulder belts, or consider using a high-back booster seat.



- High-back booster seats

If, with a backless booster seat, you cannot find a seating position that adequately supports your child's head, a high-back booster seat would be a better choice.

Children and booster seats vary in size and shape. Choose a booster that keeps the lap belt low and snug across the hips, never up across the stomach, and lets you adjust the shoulder belt to cross the chest and rest snugly near the center of the shoulder.

The following drawings compare the ideal fit to a shoulder belt uncomfortably close to the neck and a shoulder belt that could slip off the shoulder. The drawings also show how the lap belt should be low and snug across the child's hips.



# Child Safety



If the booster seat slides on the vehicle seat upon which it is being used, placing a rubberized mesh sold as shelf or carpet liner under the booster seat may improve this condition. Do not use any item thicker than this under the booster seat. Check with the booster seat manufacturer's instructions.

## CHILD SAFETY LOCKS



**WARNING:** You cannot open the rear doors from inside if you have put the child safety locks on.



A child safety lock is on the rear edge of each rear door and must be set separately for each door.

### Left-Hand Side

Turn it clockwise to switch the child lock on and counterclockwise to switch it off.

### Right-Hand Side

Turn it counterclockwise to switch the child lock on and clockwise to switch it off.

# Seatbelts

## SEATBELT PRECAUTIONS

 **WARNING:** Always drive and ride with your seatback upright and the lap belt snug and low across the hips.

 **WARNING:** Children must always be properly restrained.

 **WARNING:** Do not allow a passenger to hold a child on their lap when your vehicle is moving. Failure to follow this instruction could result in personal injury or death in the event of a sudden stop or crash.

 **WARNING:** All occupants of your vehicle, including the driver, should always properly wear their seatbelts, even when an airbag supplemental restraint system is provided. Failure to properly wear your seatbelt could seriously increase the risk of injury or death.

 **WARNING:** It is extremely dangerous to ride in a cargo area, inside or outside of a vehicle. In a crash, people riding in these areas are more likely to be seriously injured or killed. Do not allow people to ride in any area of your vehicle that is not equipped with seats and seatbelts. Make sure everyone in your vehicle is in a seat and properly using a seatbelt. Failure to follow this warning could result in serious personal injury or death.

 **WARNING:** In a rollover crash, an unbelted person is significantly more likely to die than a person wearing a seatbelt.

 **WARNING:** Each seating position in your vehicle has a specific seatbelt assembly made up of one buckle and one tongue designed to be used as a pair. Use the shoulder belt on the outside shoulder only. Never wear the shoulder belt under the arm. Never use a single seatbelt for more than one person.

 **WARNING:** Even with advanced restraints systems, properly restrain children 12 and under in a rear seating position. Failure to follow this could seriously increase the risk of injury or death.

 **WARNING:** Seatbelts and seats may be hot in a vehicle that is in the sunshine. The hot seatbelts or seats may burn a small child. Check seat covers and buckles before you place a child anywhere near them.

 **WARNING:** If your vehicle is involved in a crash, have the seatbelts and associated components inspected as soon as possible. Failure to follow this instruction could result in personal injury or death.

All seating positions in this vehicle have seatbelts. All occupants of the vehicle should properly wear their seatbelts, even when an airbag supplemental restraint system is provided.

The seatbelt system consists of:

- Lap and shoulder seatbelts.
- A shoulder seatbelt with automatic locking mode, except driver seatbelt.
- Height adjusters at the front outermost seating positions.
- Seatbelt pretensioners at the front outermost and rear outermost seating positions.

# Seatbelts



A seatbelt warning light and chime.



Crash sensors and monitoring system with readiness indicator.

The seatbelt pretensioners are designed to tighten the seatbelts when activated. In frontal and near-frontal crashes, the seatbelt pretensioners may be activated alone or, if the crash is of sufficient severity, together with the front airbags. In side crashes and rollovers, the pretensioners will be activated when the Safety Canopy is activated.

## FASTENING AND UNFASTENING THE SEATBELTS

This applies to all seating positions.

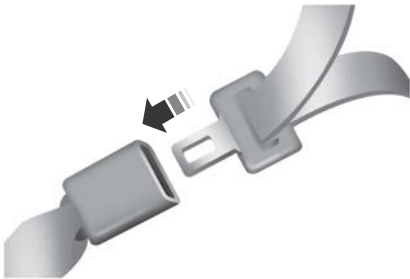

1. Insert the seatbelt tongue into the buckle until you hear a snap and feel it latch.

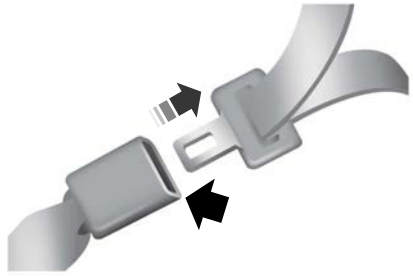

2. Press the button to release the seatbelt.

### Fastening the Cinch Tongue



**WARNING:** Always drive and ride with your seatback upright and the lap belt snug and low across the hips.

1. Pull the seatbelt from the retractor so the shoulder belt portion of the seatbelt crosses your shoulder and chest.
2. Make sure the belt is not twisted. If the belt is twisted, remove the twist.
3. Insert the belt tongue into the proper buckle for your seating position until you hear a snap and feel it latch.
4. Pull on the tongue to make sure it is securely fastened to the buckle.

While you are fastened in the seatbelt, the seatbelt with a cinch tongue adjusts to your movement. However, if you brake hard, turn hard, or if your vehicle receives an impact of 5 mph (8 km/h) or more, the seatbelt locks to help reduce your forward movement.

# Seatbelts

## SENSITIVE LOCKING MODE

### WHAT IS SENSITIVE LOCKING MODE

Sensitive locking mode is a seatbelt retractor feature that allows shoulder belt length adjustment according to your movements and locking in response to vehicle movement.

### HOW DOES SENSITIVE LOCKING MODE WORK

If the driver suddenly brakes, turns a corner sharply, or the vehicle receives an impact of about 5 mph (8 km/h) or more, the seatbelts lock to help reduce forward movement of the driver and passengers.

In addition, the seatbelt retractor locks if you pull the seatbelt webbing out too quickly. If the retractor locks, slowly lower the height adjuster to allow the seatbelt to retract.

If the retractor does not unlock, pull the seatbelt out slowly then feed a small length of webbing back toward the stowed position.

For rear seatbelts, recline the rear seat backrest or push the seat backrest cushion away from the seatbelt. Feed a small length of webbing back toward the stowed position.

## AUTOMATIC LOCKING MODE

### WHAT IS AUTOMATIC LOCKING MODE

This feature keeps the seatbelts pre-locked. The belt still retracts to remove any slack in the shoulder belt.

## WHEN TO USE AUTOMATIC LOCKING MODE

Use this mode any time you install a child restraint in any seating position. Properly restrain children 12 years old and under in the rear seat whenever possible. See **Child Safety** (page 36).

**Note:** *Automatic locking mode is not available on the driver seatbelt.*

## ENGAGING AUTOMATIC LOCKING MODE



1. Fasten the combination lap and shoulder belt.
2. Grasp the shoulder portion and pull downward until you pull the entire belt out.
3. Allow the belt to retract. As the belt retracts, you will hear a clicking sound. This indicates the seatbelt is now in the automatic locking mode.

## DISENGAGING AUTOMATIC LOCKING MODE

Unbuckle the combination lap and shoulder belt and allow it to retract completely to disengage the automatic locking mode and activate the vehicle sensitive locking mode.

# Seatbelts

## ADJUSTING THE SEATBELTS DURING PREGNANCY



**WARNING:** Always ride and drive with your seatback upright and properly fasten your seatbelt. Fit the lap portion of the seatbelt snugly and low across the hips. Position the shoulder portion of the seatbelt across your chest. Pregnant women must follow this practice. See the following figure.

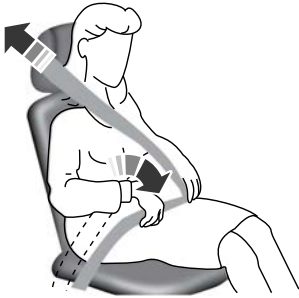

Pregnant women should always wear their seatbelt. Position the lap belt portion of a combination lap and shoulder belt low across the hips below the belly and worn as tight as comfort allows. Position the shoulder belt to cross the middle of the shoulder and the center of the chest.

## ADJUSTING THE SEATBELT HEIGHT



**WARNING:** Position the seatbelt height adjuster so that the seatbelt rests across the middle of your shoulder. Failure to adjust the seatbelt correctly could reduce its effectiveness and increase the risk of injury in a crash.

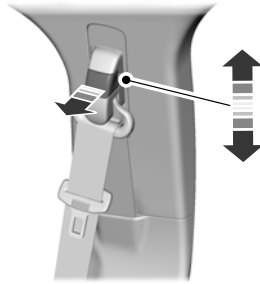

1. Pull the button and slide the height adjuster up or down.
2. Release the button and pull down on the height adjuster to make sure it is locked in place.

## ADJUSTING THE SEATBELT LENGTH



1. Pull some seatbelt webbing out of the shoulder belt retractor.
2. While holding the webbing below the tongue, grasp the metal tip of the tongue so that it is parallel to the webbing and slide the tongue up.
3. Provide enough lap belt length so that the tongue can reach the buckle.

# Seatbelts

## SEATBELT REMINDER

### HOW DOES THE SEATBELT REMINDER WORK

This feature supplements the seatbelt warning function by providing additional reminders that intermittently sound a tone and illuminate the seatbelt warning lamp when you are in the driver seat or you have a front seat passenger and a seatbelt is unbuckled.

The system uses information from the front passenger sensing system to determine if a front seat passenger is present and therefore potentially in need of a warning. To avoid the system switching on the Belt-Minder feature for objects you place on the front passenger seat, only the front seat passengers receive warnings as determined by the front passenger sensing system.

If the Belt-Minder warnings expire (warnings for about five minutes) for one passenger (driver or front passenger), the other passenger can still cause the Belt-Minder feature to switch on.

<b>If</b>	<b>Then</b>
You and the front seat passenger buckle your seatbelts before you switch the ignition on or less than 1–2 minutes elapse after you switch the ignition on...	The Belt-Minder feature will not activate.
You or the front seat passenger do not buckle your seatbelts before your vehicle reaches at least 6.0 mph (9.7 km/h) and 1–2 minutes elapse after you switch the ignition on...	The Belt-Minder feature activates, the seatbelt warning lamp illuminates and an indicator tone sounds for 6 seconds every 25 seconds, repeating for about 5 minutes or until you and the front seat passenger buckle your seatbelts.
The seatbelt for the driver or front passenger is unbuckled for about 1 minute while the vehicle is traveling at least 6.0 mph (9.7 km/h) and more than 1–2 minutes elapse after you switch the ignition on...	The Belt-Minder feature activates, the seatbelt warning lamp illuminates and an indicator tone sounds for 6 seconds every 25 seconds, repeating for about 5 minutes or until you and the front seat passenger buckle your seatbelts.

# Seatbelts

## SEATBELT REMINDER INDICATORS

A warning lamp illuminates if the ignition is on, a front seat is occupied and the seatbelt has not been fastened.



The warning lamp illuminates until you fasten your seatbelt.

## SEATBELT REMINDER AUDIBLE WARNINGS

A warning tone sounds and the warning lamp illuminates if you are not wearing your seatbelt when your vehicle exceeds a relatively low speed.

The warning tone sounds for a short period of time or until you fasten your seatbelt.

## SWITCHING THE SEATBELT REMINDER ON AND OFF



**WARNING:** While the system allows you to deactivate it, this system is designed to improve your chances of being safely belted and surviving an accident. We recommend you leave the system activated for yourself and others who may use the vehicle.

**Note:** *The driver and front passenger warnings switch off independently. When you perform this procedure for one seating position, do not buckle the other position as this cancels the process.*

**Note:** *If you are using MyKey, you cannot disable the seatbelt reminder. Also, if the seatbelt reminder has been previously disabled, it will be re-enabled during the use of MyKey. See **MyKey™** (page 76).*

Read Steps 1 - 4 before proceeding with the programming procedure.

Make sure that:

- The parking brake is set.
  - The transmission is in park (P).
  - The ignition is off.
  - The driver and front passenger seatbelts are unfastened.
1. Switch the ignition on. Do not start the engine.
  2. Wait about one minute until the seatbelt warning light switches off. After Step 2, wait an additional five seconds before proceeding with Step 3. Once you start Step 3, you must complete the procedure within 30 seconds.
  3. For the seating position you are switching off, buckle then unbuckle the seatbelt three times at a moderate speed, ending in the unbuckled state. After Step 3, the seatbelt warning light switches on.
  4. When the seatbelt warning light is on, buckle then unbuckle the seatbelt. After Step 4, the seatbelt warning light flashes for confirmation.

This switches the feature off for that seating position if it is currently on.

This switches the feature on for that seating position if it is currently off.

## CHECKING THE SEATBELTS

Check the seatbelts and child restraints periodically to make sure they work properly and are not damaged. Make sure there are no nicks, tears or cuts. Replace if necessary.

Check the following seatbelt assemblies after a crash.

- Retractors.
- Buckles.
- Front seatbelt buckle assemblies.



# Seatbelts

- Shoulder belt height adjusters.
- Shoulder belt guide on seat backrest.
- Child restraint LATCH and tether anchors.
- Attaching hardware.

Read the child restraint manufacturer's instructions for additional inspection and maintenance information specific to the child restraint.

We recommend that all seatbelt assemblies in use in vehicles involved in a crash be replaced. However, if the crash was minor and an authorized dealer finds that the belts do not show damage and continue to operate properly, they do not need to be replaced. Seatbelt assemblies not in use during a crash should also be checked and replaced if either damage or improper operation is noted.

Properly care for seatbelts. See **Cleaning Seatbelts** (page 446).



**WARNING:** Do not use extensions to change the way the seatbelt fits across the torso, over the lap or to make the seatbelt buckle easier to reach.

If, because of body size or driving position, it is not possible to properly fasten the seatbelt over your lap and shoulder, an extension that is compatible with the seatbelts is available free of charge from our dealers. Only use our seatbelt extensions made by the original equipment seatbelt manufacturer with our seatbelts. Ask your authorized dealer if your extension is compatible with your vehicle restraint system.

## SEATBELT EXTENSIONS



**WARNING:** Persons who fit into the vehicle's seatbelt should not use an extension. Unnecessary use could result in serious personal injury in the event of a crash.



**WARNING:** Only use extensions provided free of charge by our dealers. The dealer will provide an extension designed specifically for this vehicle, model year and seating position. The use of an extension intended for another vehicle, model year or seating position may not offer you the full protection of your vehicle's seatbelt restraint system.



**WARNING:** Never use seatbelt extensions to install child restraints.

# Personal Safety System™

---

## WHAT IS THE PERSONAL SAFETY SYSTEM

An advanced safety system that protects occupants in frontal crashes.

## HOW DOES THE PERSONAL SAFETY SYSTEM WORK

This system provides an improved level of frontal crash protection to front seat occupants and is designed to reduce the risk of airbag-related injuries. The system analyzes occupant conditions and crash severity before activating the appropriate safety devices. During a crash, the restraints control module may deploy the seatbelt pretensioners, and one or both stages of the dual-stage airbags based on crash severity and occupant conditions.

## PERSONAL SAFETY SYSTEM COMPONENTS

- Driver and passenger dual-stage airbag supplemental restraints.
- Front seat outermost seatbelts with pretensioners, energy management retractors and seatbelt usage sensors.
- Front passenger sensing system.
- Passenger airbag off and on indicators.
- Front crash severity sensors.
- Restraints control module with impact and safing sensors.
- Restraint system warning light and tone.
- The electrical wiring for the airbags, crash sensors, seatbelt pretensioners, front seatbelt usage sensors, front passenger sensing system and indicator lights.

# Airbags

## HOW DO THE FRONT AIRBAGS WORK

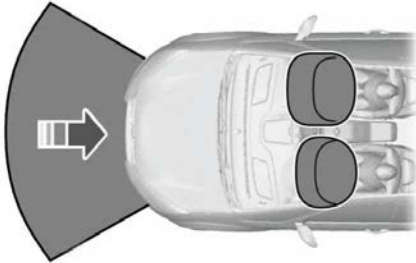

The driver and front passenger airbags deploy during significant frontal and near frontal crashes.

The driver and passenger front airbag system consists of:

- Driver and passenger airbag modules.
- Front passenger sensing system.
- Crash sensors and monitoring system with readiness indicator. See **Crash Sensors and Airbag Indicator** (page 62).

The airbags are a supplemental restraint system and are designed to work with the seatbelts to help protect the driver and right front passenger from certain upper body injuries. Airbags do not inflate slowly; there is a risk of injury from a deploying airbag.

**Note:** *You will hear a loud bang and see a cloud of harmless powdery residue if an airbag deploys. This is normal.*

The airbags inflate and deflate rapidly upon activation. After airbag deployment, it is normal to notice a smoke-like, powdery residue or smell the burnt propellant. This may consist of cornstarch, talcum powder (to lubricate the bag) or sodium

compounds (for example, baking soda) that result from the combustion process that inflates the airbag. Small amounts of sodium hydroxide may be present which may irritate the skin and eyes, but none of the residue is toxic.

Contact with a deploying airbag may cause abrasions or swelling. Temporary hearing loss is also a possibility as a result of the noise associated with a deploying airbag.

Because airbags must inflate rapidly and with considerable force, there is the risk of death or serious injuries such as fractures, facial and eye injuries or internal injuries, particularly to occupants who are not properly restrained or are otherwise out of position at the time of airbag deployment. Thus, it is extremely important that occupants be properly restrained as far away from the airbag module as possible while maintaining vehicle control.

Routine maintenance of the airbags is not required.

## HOW DO THE SIDE AIRBAGS WORK



**WARNING:** Do not place objects or mount equipment on or near the airbag cover, on the side of the front or rear seatbacks, or in areas that may come into contact with a deploying airbag. Failure to follow these instructions may increase the risk of personal injury in the event of a crash.



**WARNING:** Accessory seat covers not released by Ford Motor Company could prevent the deployment of the airbags and increase the risk of injuries in a crash.

# Airbags



**WARNING:** Do not lean your head on the door. The side airbag could injure you as it deploys from the side of the seatback.

The side airbags are on the outermost side of the seat backrests of the front seats. In certain sideways crashes or rollovers, the airbags will be inflated. The airbag was designed to inflate between the door panel and occupant to further enhance the protection provided to occupants in side impact crashes.



The system consists of the following:

- A label or embossed side panel indicating that side airbags are fitted to your vehicle.
- Side airbags inside the driver and front passenger seat backrests.
- Crash sensors and monitoring system with readiness indicator. See **Crash Sensors and Airbag Indicator** (page 62).

## HOW DO THE KNEE AIRBAGS WORK

Driver and passenger knee airbags are under or within the instrument panel. During a crash, the restraints control module may activate the driver and passenger knee airbags (individually or both) based on crash severity and respective occupant conditions. Under certain crash and occupant conditions, the driver and passenger knee airbags may deploy (individually or both) but the corresponding front airbag may not activate. It is important to be properly seated and restrained to reduce the risk of death or serious injury.



Make sure the knee airbags are operating properly. See **Crash Sensors and Airbag Indicator** (page 62).

## HOW DOES THE SAFETY CANOPY™ WORK



**WARNING:** Do not place objects or mount equipment on or near the headliner at the siderail that may come into contact with a deploying curtain airbag. Failure to follow these instructions may increase the risk of personal injury in the event of a crash.



**WARNING:** Do not lean your head on the door. The curtain airbag could injure you as it deploys from the headliner.



**WARNING:** To reduce risk of injury, do not obstruct or place objects in the deployment path of the airbag.

# Airbags

The Safety Canopy deploys during significant side crashes or when a certain likelihood of a rollover event is detected by the rollover sensor. The Safety Canopy is mounted to the roof side-rail sheet metal, behind the headliner, above each row of seats. In certain sideways crashes or rollover events, the Safety Canopy will be activated, regardless of which seats are occupied. The Safety Canopy inflates between the side window area and occupants to further enhance protection provided in side impact crashes and rollover events.

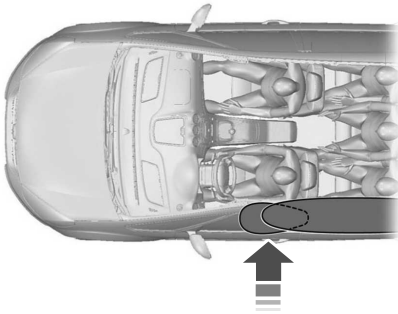

The system consists of the following:

- Safety Canopy curtain airbags above the trim panels over the front and rear side windows identified by a label or wording on the headliner or roof-pillar trim.
- A flexible headliner which opens above the side doors to allow air curtain deployment





• Crash sensors and monitoring system with a readiness indicator. See **Crash Sensors and Airbag Indicator** (page 62).

Properly restrain children 12 years old and under in the rear seats. The Safety Canopy will not interfere with children restrained using a properly installed child or booster seat because it is designed to inflate downward from the headliner above the doors along the side window opening.

## AIRBAG PRECAUTIONS

 **WARNING:** Airbags do not inflate slowly or gently, and the risk of injury from a deploying airbag is the greatest close to the trim covering the airbag module.

 **WARNING:** All occupants of your vehicle, including the driver, should always properly wear their seatbelts, even when an airbag supplemental restraint system is provided. Failure to properly wear your seatbelt could seriously increase the risk of injury or death.

 **WARNING:** Properly secure children 12 years old and under in a rear seating position whenever possible. If you are unable to properly secure all children in a rear seating position, properly secure the largest child on the front seat. If you must use a forward facing child restraint on the front seat, move the seat as far back as possible. Failure to follow these instructions could result in personal injury or death.

 **WARNING:** Do not place your arms on the airbag cover or through the steering wheel. Failure to follow this instruction could result in personal injury.

# Airbags

 **WARNING:** Keep the areas in front of the airbags free from obstruction. Do not affix anything to or over the airbag covers. Objects could become projectiles during airbag deployment. Failure to follow this instruction could result in personal injury or death.

 **WARNING:** To reduce risk of injury, do not obstruct or place objects in the deployment path of the airbag.

 **WARNING:** Do not place a rearward facing child restraint in front of an active airbag. Failure to follow this instruction could result in personal injury or death.

 **WARNING:** Do not attempt to service, repair, or modify the supplementary restraint system or associated components. Failure to follow this instruction could result in personal injury or death.

 **WARNING:** Several airbag system components get hot after inflation. To reduce the risk of injury, do not touch them after inflation.

 **WARNING:** If a supplementary restraint system component has deployed, it will not function again. Have the system and associated components inspected as soon as possible. Failure to follow this instruction could result in personal injury or death.

## PROPERLY ADJUSTING THE DRIVER AND FRONT PASSENGER SEATS

 **WARNING:** National Highway Traffic Safety Administration (NHTSA) recommends a minimum distance of at least 10 in (25 cm) between an occupant's chest and the driver airbag module.

To properly position yourself away from the airbag:

- Move your seat to the rear as far as you can while still reaching the pedals comfortably.
- Recline the seat slightly one or two degrees from the upright position.

After all occupants have adjusted their seats and put on seatbelts, it is very important that they continue to sit properly. Properly seated occupants sit upright, lean against the seat backrest, and center themselves on the seat cushion, with their feet comfortably extended on the floor. Sitting improperly can increase the chance of injury in a crash event. For example, if an occupant slouches, lies down, turns sideways, sits forward, leans forward or sideways, or puts one or both feet up, the chance of injury during a crash greatly increases.

## CHILDREN AND AIRBAGS

 **WARNING:** Do not place a rearward facing child restraint in front of an active airbag. Failure to follow this instruction could result in personal injury or death.

# Airbags



Children must always be properly restrained. Accident statistics suggest that children are safer when properly restrained in the rear seating positions than in the front seating position. Failure to follow these instructions may increase the risk of injury in a crash.

## FRONT PASSENGER SENSING SYSTEM

### WHAT IS THE FRONT PASSENGER SENSING SYSTEM

This system detects a properly seated occupant and determines if the front passenger airbag should be enabled.

### HOW DOES THE FRONT PASSENGER SENSING SYSTEM WORK

The system uses a passenger airbag status indicator which illuminates indicating that the front passenger frontal airbag is either enabled or disabled.

**Note:** *When you first switch the ignition on, the passenger airbag status indicator off and on lamps illuminate for a short period to confirm they are functional.*

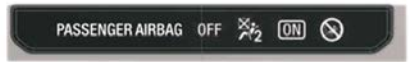

The indicator lamps are in the overhead console.

The front passenger sensing system is designed to disable the front passenger frontal airbag under these conditions:

- The front passenger seat is unoccupied.
- The system determines an infant is present in a child restraint.
- A passenger takes their weight off of the seat for a period of time.
- If there is a problem with the airbag system or the passenger sensing system.

Even with this technology, parents are strongly encouraged to always properly restrain children in the rear seat.

- When the front passenger sensing system disables the front passenger frontal airbag, the passenger airbag status indicator illuminates the off lamp.
- If you have installed the child restraint and the passenger airbag status indicator illuminates the on lamp, switch your vehicle off, remove the child restraint from your vehicle and reinstall the restraint following the child restraint manufacturer's instructions.

The front passenger sensing system works with sensors that are part of the front passenger seat and seatbelt. The sensors are designed to detect the presence of a properly seated occupant and determine if the front passenger frontal airbag should be enabled.

# Airbags

- When the front passenger sensing system enables the front passenger frontal airbag, the passenger airbag status indicator illuminates the on lamp.

If a person of adult size is sitting in the front passenger seat, but the passenger airbag status indicator off lamp is illuminated, it is possible that the person is not sitting properly in the seat. If this happens:

- Switch your vehicle off and ask the person to place the seat backrest in an upright position.
- Have the person sit upright in the seat, centered on the seat cushion, with the person's legs comfortably extended.
- Restart your vehicle and have the person remain in this position for about two minutes. This allows the system to detect that person and enable the passenger frontal airbag.
- If the indicator off lamp remains illuminated even after this, you should advise the person to ride in the rear seat.

After all occupants have adjusted their seats and put on seatbelts, it is very important that they continue to sit upright, leaning against the seat backrest, and centered on the seat cushion, with their feet comfortably extended on the floor.

Sitting improperly can increase the chance of injury in a crash event. For example, if an occupant slouches, lies down, turns sideways, sits forward, leans forward or sideways, or puts one or both feet up, the chance of injury during a crash greatly increases.

If you think that the state of the passenger airbag status indicator lamp is incorrect, check for the following:

- Objects lodged underneath the seat.
- Objects between the seat cushion and the center console.

- Objects hanging off the seat backrest.
- Objects stowed in the seat backrest map pocket.
- Objects placed on the occupant's lap.
- Cargo interference with the seat
- Other passengers pushing or pulling on the seat.
- Rear passenger feet and knees resting or pushing on the seat.

The listed conditions could cause the weight of a properly seated occupant to be incorrectly interpreted by the front passenger sensing system. The person in the front passenger seat could appear heavier or lighter due to the conditions listed.



Make sure the front passenger sensing system is operating properly. See **Crash Sensors and Airbag Indicator** (page 62).

If the airbag readiness light is on, do the following:

- Pull your vehicle over.
- Switch your vehicle off.
- Check for any objects lodged underneath the front passenger seat or cargo interfering with the seat.
- Remove the obstruction if found.
- Restart your vehicle.
- Wait at least two minutes and verify that the airbag readiness light in the instrument cluster is no longer illuminated.
- If the airbag readiness light in the instrument cluster remains illuminated, there may be a problem due to the front passenger sensing system.

Do not attempt to repair or service the system. Take your vehicle in for service immediately.



# Airbags

If it is necessary to modify an advanced front airbag system to accommodate a person with disabilities, contact your Customer Relationship Center. See **Contacting Us** (page 19).

## FRONT PASSENGER SENSING SYSTEM PRECAUTIONS



**WARNING:** Sitting improperly, out of position or with the seatback reclined too far can take weight off the seat cushion and affect the decision of the passenger sensing system, resulting in serious injury or death in the event of a crash. Always sit upright against your seat back, with your feet on the floor.



**WARNING:** Any alteration or modification to the front passenger seat may affect the performance of the front passenger sensing system. This could seriously increase the risk of injury or death.

## FRONT PASSENGER SENSING SYSTEM INDICATORS

Occupant	Passenger Airbag Status Indicator	Passenger Airbag
Empty	OFF: Illuminated	Disabled
	ON: Not Illuminated	
Child	OFF: Illuminated	Disabled
	ON: Not Illuminated	
Adult	OFF: Not Illuminated	Enabled
	ON: Illuminated	

# Airbags

## CRASH SENSORS AND AIRBAG INDICATOR



**WARNING:** Modifying or adding equipment to the front of your vehicle could affect the performance of the airbag system, increasing the risk of injury. This includes the hood, bumper system, frame, front body structure, tow hooks, hood pins, push bar and snowplows.

Your vehicle has a collection of crash and occupant sensors. These sensors provide information to the restraints control module which activates the following:

- Front seatbelt pretensioners.
- Driver airbag.
- Passenger airbag.
- Knee airbag(s).
- Seat mounted side airbags.
- Safety Canopy.

Based on the type of crash, the restraints control module deploys the appropriate safety devices.

The restraints control module also monitors the readiness of the above safety devices plus the crash and occupant sensors. The readiness of the safety system is indicated by a warning indicator light in the instrument cluster or by a backup tone if the warning light is not working. Routine maintenance of the airbag is not required.

A difficulty with the system is indicated by one or more of the following:



The readiness light will not illuminate immediately after you switch the ignition on.

- The readiness light either flashes or stays on.
- You hear a series of five tones. The tone pattern repeats periodically until the problem, the light or both are repaired.

If any of these things happen, even intermittently, have the supplemental restraint system serviced immediately. Unless serviced, the system may not function properly in the event of a crash.

The fact that the seatbelt pretensioners or front airbags did not activate for both front seat occupants in a crash does not mean that something is wrong with the system. Rather, it means the restraints control module determined the accident conditions (crash severity, seatbelt usage) were not appropriate to activate these safety devices.

- The front airbags activate only in frontal and near-frontal crashes. Front airbags may activate in rollovers, side impacts or rear impacts if the crash causes sufficient frontal deceleration.
- The seatbelt pretensioners activate in frontal, near-frontal and side crashes, and in rollovers.
- The knee airbag(s) deploy based on crash severity and occupant conditions.
- The side airbags inflate in certain side impact crashes or rollover events. Side airbags may activate in other types of crashes if the vehicle experiences sufficient sideways motion or deformation.
- The Safety Canopy inflates in certain side impact crashes or rollover events. The Safety Canopy may activate in other types of crashes if the vehicle experiences sufficient sideways motion or deformation, or a certain likelihood of rollover.

# Airbags

---

## **DISPOSING OF AIRBAGS**

Contact your authorized dealer as soon as possible. Airbags must be disposed of by qualified personnel.

# Pedestrian Alert System

---

## **WHAT IS THE PEDESTRIAN ALERT SYSTEM**

Due to the quiet operation of hybrid and electric vehicles at low speeds, the system creates a subtle sound to alert pedestrians.

The system is on when your vehicle is running and not in park (P). Some sound may be audible in the passenger compartment.

## WHAT IS 911 ASSIST

911 Assist is a SYNC system feature that can call for help.

For more information, visit [www.owner.ford.com](http://www.owner.ford.com).

## HOW DOES 911 ASSIST WORK

If a crash deploys an airbag, excluding knee airbags and rear inflatable seatbelts, or activates the battery shut-off, your vehicle may be able to contact emergency services by dialing 911 through a paired and connected **Bluetooth**®-enabled phone.

Not all crashes will deploy an airbag or activate the battery shut-off. If a connected cell phone sustains damage or loses its connection to SYNC during a crash, SYNC will search for and try to connect to a previously paired cell phone. SYNC will then attempt to call the emergency services.

Before making the call:

- SYNC provides about 10 seconds to cancel the call. If you fail to cancel the call, SYNC attempts to dial 911.
- SYNC says the following, or a similar message: "SYNC will attempt to call 911, to cancel the call, press Cancel on your screen or press and hold the phone button on your steering wheel."

If you do not cancel the call and SYNC makes a successful call a pre-recorded message plays for the 911 operator. The occupants in your vehicle are able to talk with the operator. Be prepared to provide your name, phone number and location immediately because not all 911 systems are capable of receiving this information electronically.

During an emergency call the system transmits vehicle data to the emergency service.

## EMERGENCY CALL REQUIREMENTS



**WARNING:** Do not wait for 911 Assist to make an emergency call if you can do it yourself. Dial emergency services immediately to avoid delayed response time which could increase the risk of serious injury or death after a crash. If you do not hear 911 Assist within five seconds of the crash, the system or phone may be damaged or non-functional.



**WARNING:** Always place your phone in a secure location in your vehicle so it does not become a projectile or get damaged in a crash. Failure to do so may cause serious injury to someone or damage the phone which could prevent 911 Assist from working properly.



**WARNING:** Unless the 911 Assist setting is set on before a crash, the system will not dial for help which could delay response time, potentially increasing the risk of serious injury or death after a crash.

- SYNC is powered and working properly at the time of the incident and throughout feature activation and use.
- The 911 Assist feature must be set on before the incident.
- You must pair and connect a **Bluetooth**® enabled and compatible cell phone to SYNC.
- A connected **Bluetooth**® enabled phone must have the ability to make and maintain an outgoing call at the time of the incident.

## 911 Assist (If Equipped)

---

- A connected **Bluetooth**® enabled phone must have adequate network coverage, battery power and signal strength.
- The vehicle must have battery power and be located in the U.S., Canada or in a territory in which 911 is the emergency number.

**Note:** *If any user sets 911 Assist to on or off, that setting applies for all paired phones. If 911 Assist is off and the phone connected to SYNC, an icon displays on the status bar.*

**Note:** *Every phone operates differently. While SYNC 911 Assist works with most cellular phones, some may have trouble using this feature.*

### EMERGENCY CALL LIMITATIONS

The SYNC 911 Assist feature only operates in the U.S., Canada or in a territory in which 911 is the emergency number. The following are limitations of this feature:

- Your cellular phone or 911 Assist hardware sustains damage in a crash.
- The vehicle's battery or the SYNC system has no power.
- The phone(s) thrown from your vehicle are the ones paired and connected to the system.

# Keys and Remote Controls

## REMOTE CONTROL LIMITATIONS



**WARNING:** Changes or modifications not expressly approved by the party responsible for compliance could void the user's authority to operate the equipment. The term "IC:" before the radio certification number only signifies that Industry Canada technical specifications were met.

This device complies with Part 15 of the FCC Rules and with Industry Canada license-exempt RSS standard(s). Operation is subject to the following two conditions: (1) This device may not cause harmful interference, and (2) This device must accept any interference received, including interference that may cause undesired operation.

Make sure a valid remote control is within 5 ft (1.5 m) from the front door handles and rear of vehicle.

The system may not function if:

- The remote control remains stationary for about a minute.
- The vehicle battery has no charge.
- The remote control battery has no charge.
- There is interference causing issues with the remote control frequencies.
- The remote control is too close to metal objects or electronic devices, for example keys or a cell phone.

## USING THE REMOTE CONTROL

Use your remote control to access various vehicle systems.

**Note:** *The buttons on your remote may vary depending on the vehicle region or options.*

### Unlock



Press the button to unlock all doors. See **Unlocking and Locking the Doors Using the Remote Control** (page 84).

### Lock



Press the button to lock all doors. See **Unlocking and Locking the Doors Using the Remote Control** (page 84).

### Frunk



Press the button twice to open the frunk. See **Opening the Frunk Using the Remote Control** (page 335).

### Tailgate (If Equipped)



Press the button twice to open the tailgate. See **Opening the Tailgate Using the Remote Control** (page 95).

### Panic Alarm



Press the button to sound the panic alarm. See **Sounding the Panic Alarm** (page 68).

# Keys and Remote Controls

## REMOVING THE KEY BLADE



Push the release button on your passive key and pull the key blade out.

## SOUNDING THE PANIC ALARM



Press the button to sound the panic alarm. Press the button again, or switch the ignition on to turn it off.

**Note:** *The panic alarm only operates when the ignition is off.*

## LOCATING YOUR VEHICLE



Press the lock button twice within three seconds. The turn signal lamps flash.

**Note:** *We recommend you use this method to locate your vehicle.*

## CHANGING THE REMOTE CONTROL BATTERY



**WARNING:** Keep batteries away from children to prevent ingestion. Failure to follow this instruction could result in personal injury or death. If ingested, immediately seek medical attention.



**WARNING:** If the battery compartment does not securely close, stop using the remote control and replace it as soon as possible. In the meantime, keep the remote control away from children. Failure to follow this instruction could result in personal injury or death.

The remote control uses one coin-type 3-volt lithium battery CR2450 or equivalent.



1. Push the release button and pull the key blade out.



## Keys and Remote Controls

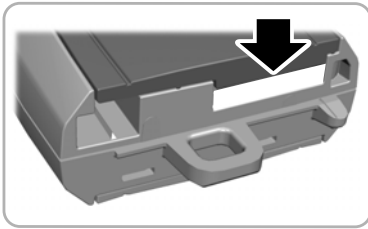

2. Twist a thin coin under the tab hidden behind the key blade head to remove the battery cover.
- 
- A diagram showing the battery cover being twisted and removed from the transmitter housing. A white arrow points up from the cover, and a black arrow points down to the cover, indicating its removal.

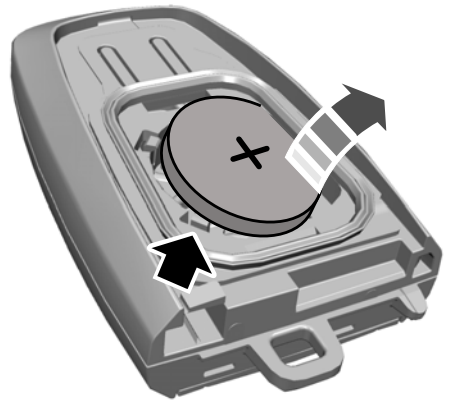

3. Insert a screwdriver, and carefully remove the battery.
4. Install a new battery with the + facing upward.
5. Reinstall the battery housing cover onto the transmitter and install the key blade.



Dispose of old batteries in an environmentally friendly way. Seek advice from your local authority about recycling old batteries.

**Note:** Do not wipe off any grease on the battery terminals or on the back surface of the circuit board.

**Note:** Replacing the battery does not erase the programmed key from your vehicle. The remote control should operate normally.

### REPLACING A LOST KEY OR REMOTE CONTROL

You can purchase replacement keys or remote controls from an authorized dealer. Authorized dealers can program remote controls for your vehicle.

# Keys and Remote Controls



**Note:** Your vehicle keys came with a security label that provides important key cut information. Keep the label in a safe place for future reference.

## PROGRAMMING THE REMOTE CONTROL

### General Information

You must have two previously programmed remote controls inside your vehicle and the new unprogrammed remote controls readily accessible. Contact an authorized dealer to have the spare remote control programmed if two previously programmed remotes are not available. Make sure that your vehicle is off before beginning this procedure. Make sure that you close all the doors before beginning and that they remain closed throughout the procedure. Perform all steps within 30 seconds of starting the sequence. Stop and wait for at least one minute before starting again if you perform any steps out of sequence.

Read and understand the entire procedure before you begin.

**Note:** You can program a maximum of four remote controls to your vehicle.

**Note:** If your programmed remote controls are lost or stolen and you do not have an extra coded remote, you need to have your vehicle towed to an authorized dealer. Store an extra programmed remote away from your vehicle in a safe place to help prevent any inconvenience. Contact an authorized dealer to purchase additional spare or replacement remotes.

## Steps for Programming Your Spare Remote Control

### Programming Backup Location

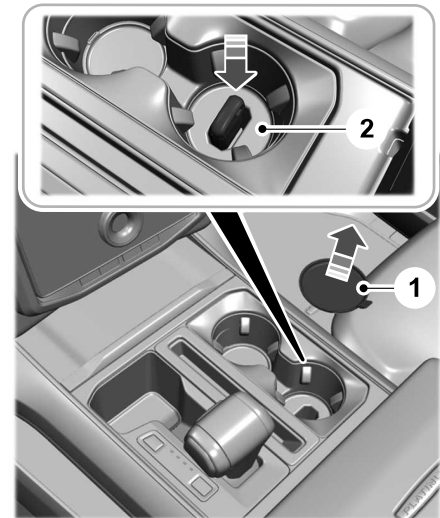

1. Access the backup slot.
2. Place the first programmed remote in the backup slot with your foot off the brake pedal, press and release the push button ignition switch.
3. Wait five seconds and then press and release the push button ignition switch again.
4. Remove the remote control.

# Keys and Remote Controls

---

5. Within 10 seconds, place a second programmed remote control in the backup slot. Press and release the push button ignition switch.
  6. Wait five seconds and then press and release the push button ignition switch again. Keep the ignition on for at least three seconds, but no more than 10 seconds.
  7. Remove the remote control.
  8. Place the unprogrammed remote control in the backup slot and press and release the push button ignition switch.
- Programming is now complete. With your foot on the brake pedal, press the push button ignition switch to verify the remote control functions operate and your vehicle starts with the new remote control.
- If programming was not successful, wait 10 seconds and repeat Steps 1 through 8. If you are still unsuccessful, take your vehicle to an authorized dealer.

## KEYS AND REMOTE CONTROLS – TROUBLESHOOTING

### KEYS AND REMOTE CONTROLS – INFORMATION MESSAGES

Message	Action
Key Battery Low Replace Soon	Replace remote control battery.

# Phone as a Key (If Equipped)

## WHAT IS PHONE AS A KEY

Phone as a Key allows you to use your phone in place of a passive key.

You can use your phone for the following functions:

- Remote locking and unlocking.
- Passive entry and exit.
- Passive start and drive the vehicle.
- Remote start.
- Memory function recall.

## PHONE AS A KEY LIMITATIONS

Limitations can vary based on the make and model of your phone, phone location and physical obstructions.

The following items could impact Phone as a Key performance or prevent functionality in some cases:

- The typical operating range for Phone as a Key is 131 ft (40 m).
- Your **Bluetooth®** connection is not enabled, is disrupted, or out of range.
- Your Phone as a Key is not active or enabled on at least one phone.
- Your vehicle battery has depleted.
- Your phone battery has depleted.
- Interference from other devices using radio frequencies or physical obstructions.
- Your phone is too close to metal objects or other electronic devices.

**Note:** Do not leave a duplicate coded key in the vehicle. Always take your keys and phone and lock all doors when leaving the vehicle.

## PROGRAMMING YOUR PHONE

To program your smartphone as phone as a key:

1. Visit your device's app store to download the FordPass app.
2. Create a new account or sign-in to an existing account on the FordPass app.
3. Add the vehicle identification number to your account and follow the prompts in the FordPass app to complete the Sync Connect Authorization process.
4. After the authorization is complete, you can set up phone as a key following the prompts in the FordPass app.
5. After phone as a key is set up, you can set up the backup start passcode by following the prompts on your touchscreen.

**Note:** Keep your new backup start passcode with you in case of an emergency.

## Resetting Phone as a Key

1. Access the vehicle drawer on the touchscreen.
2. Press **SETTINGS**.
3. Press **General**.
4. Press **Reset**.
5. Press the app connect reset option.
6. Press **Reset All**.
7. Confirm you would like to continue with erasing all phone as a key settings, keys and backup start passcodes.
8. Press **Continue**.
9. Confirm you are aware you are de-authorizing all authorized users and FordPass Connect settings.
10. Press **Continue**.

# Phone as a Key (If Equipped)

## USING THE VALET MODE

### Classic Valet Mode

#### Enabling Valet Mode

Make sure the remote control is in your vehicle.

1. Access the vehicle drawer on the touchscreen.
2. Press **CONTROLS**.
3. Press **Valet Mode**.
4. Enter a four digit code to lock the touchscreen.
5. Re-enter the same four digit code to complete enabling valet mode.

#### Disabling Valet Mode

1. Press **Exit Valet Mode**.
2. Enter your four digit code to disable valet mode and unlock your touchscreen.

### Enhanced Valet Mode

#### Enabling Valet Mode

Have your backup start passcode completely set up before using valet mode. See **Programming Your Phone** (page 72).

**Note:** *If your vehicle detects a remote control, the system defaults to classic valet mode.*

1. Access the vehicle drawer on the touchscreen.
2. Press **CONTROLS**.
3. Press **Valet Mode**.

**Note:** *If the system detects a valid phone as a key, the temporary passcode displays in both the touchscreen and mobile app.*

**Note:** *If the system does not detect a valid phone as a key, it prompts you to enter your backup start passcode on the touchscreen. Once validated, the temporary passcode displays on the touchscreen.*

4. Provide the valet the first five digits of the passcode to enter on the keyless entry keypad to unlock your vehicle.
5. Provide the valet the eight-digit passcode to enter on the touchscreen to start and drive your vehicle.

#### Disabling Valet Mode

1. Press **Exit Valet Mode**.

**Note:** *If the system detects an authorized phone as a key, valet mode disables.*

**Note:** *If the system does not detect a valid phone as a key, it prompts you to enter your backup start passcode. Once validated, valet mode disables.*

## USING THE BACKUP START PASSCODE

Make sure you have phone as a key active on at least one phone to use a previously created backup start passcode. See **Programming Your Phone** (page 72).

1. Press the brake pedal and the push button start. If the system does not detect a valid phone as a key or remote control, a message appears on the touchscreen and prompts you for your backup start passcode.

**Note:** *The touchscreen times out after 30 seconds with no interaction.*

**Note:** *If the backup start passcode screen does not appear, press the brake pedal and push button start again.*

2. Use the touchscreen to enter your backup start passcode.
3. After entering your passcode, press return within 30 seconds.

## Phone as a Key (If Equipped)

---

- Once the system validates the backup start passcode, a message alerts you to start your vehicle.
- Press the brake pedal and the push button start within 20 seconds to start the vehicle.
- If your vehicle does not start, repeat steps 1-5.

### System Lockout

The system locks after five combined incorrect attempts of the following:

- Entering a backup start passcode.
- Resetting a current passcode.
- Entering a valet mode passcode.

**Note:** *The system remains locked for five minutes. After five minutes the system allows codes to be entered again.*

## PHONE AS A KEY – TROUBLESHOOTING

### PHONE AS A KEY – FREQUENTLY ASKED QUESTIONS

#### How can I tell if my vehicle has Phone as a Key?

The touchscreen shows the Phone as a Key reset option if your vehicle has Phone as a Key. If you have registered your vehicle through the FordPass app, a control button appears on the home screen of the FordPass app.

#### What happens if I cannot unlock the vehicle with Phone as a Key?

Attempt to move your phone closer to the vehicle. Check that the FordPass app is still running and that the Phone as a Key control screen shows connected. If the phone is connected, attempt to press the remote unlock button in the FordPass app. If the phone is not connected or the remote unlock button does not work in the FordPass app, attempt to force close and restart the app.

#### Why do I get a No Key Detected message in the instrument cluster display when I am using Phone as a Key and my phone is in the car?

Your phone's Bluetooth connection has been disrupted or is not connected. Try reconnecting your phone's Bluetooth connection. Move the phone closer to the center of the vehicle near the cup holder or center console. Verify your Phone as a Key is still active, enabled and has not been revoked.

#### What do I do if my phone is lost, damaged, or the battery has depleted?

Use the Backup Start Passcode that you created to protect you in the event that you lose your phone, damage it, or the battery depletes. See **Using the Backup Start Passcode** (page 73).

#### How many phones can I use for Phone as a Key?

You can program and activate up to four phones with Phone as a Key to your vehicle.

## Phone as a Key (If Equipped)

---

### **How does a valet drive my car if I only use my Phone as a Key?**

Have the valet use the temporary valet passcode that you created when using valet mode. See **Using the Valet Mode** (page 73).

### **I uninstalled my FordPass app and reinstalled it. Why am I not able to get a new Phone as a Key?**

Remove the Phone as a Key that was previously associated with your phone or reset Phone as a Key from your vehicle, and then request a new Phone as a Key. See **Connecting Your Phone** (page 527).

### **Why can I not remotely start the vehicle with my Phone as a Key?**

Using the FordPass app, verify your Phone as a Key setup is complete and enabled via Bluetooth connection on at least one phone. If Bluetooth has connected but Phone as a Key setup is not complete, complete the setup of your Phone as a Key, as prompted from the FordPass app. See **Connecting Your Phone** (page 527).

# MyKey™ - Vehicles With: 12.3 Inch Screen

## WHAT IS MYKEY

MyKey allows you to program keys and mobile devices with restricted driving modes to promote good driving habits.

## MYKEY SETTINGS

### NON-CONFIGURABLE MYKEY SETTINGS

#### Seatbelt Reminder or Belt-Minder™

MyKey mutes the audio system until the front seat belts are buckled.

**Note:** *If your vehicle includes an AM/FM radio or a very basic audio system, then the radio may not mute.*

#### Satellite Radio (If Equipped)

Some Satellite radio channels have restricted access to adult radio content.

#### Driving and Parking Aids

Settings for parking aids, blind spot information system, and cross traffic alert cannot be configured. These systems turn on when the vehicle turns on and cannot be switched off with a MyKey.

Settings for pre-collision assist and lane keeping cannot be configured. These systems turn on when the vehicle turns on but can be switched off with a MyKey.

A new destination in the navigation system can only be set using voice commands when using a MyKey, and with your vehicle moving.

**Note:** *MyKey drivers may be able to turn the lane departure warning feature off, but this feature turns back on automatically with every new key cycle.*

## CONFIGURABLE MYKEY SETTINGS

You can configure the following settings after creating a MyKey. See **Creating a MyKey** (page 77).

### Speed Limit



**WARNING:** Do not set MyKey maximum speed limit to a limit that will prevent the driver from maintaining a safe speed considering posted speed limits and prevailing road conditions. The driver is always responsible to drive in accordance with local laws and prevailing conditions. Failure to do so could result in accident or injury.

You can set a speed limit for your vehicle. Warning messages appear on the touchscreen and a tone sounds if your vehicle reaches the set speed. You cannot override the set speed when using a MyKey.

### Speed Minder

You can set a speed reminder for your vehicle. Warning messages appear on the touchscreen and a tone sounds if your vehicle exceeds the set speed.

### Audio System Volume Limit

The audio system maximum volume reduces. A message appears on the touchscreen if you attempt to exceed the volume limit. Automatic volume control turns off.

### Emergency Assistance

If you set emergency assistance to always on, you cannot switch it off with a MyKey.

### Do Not Disturb

If you set do not disturb to always on, you cannot switch it off with a MyKey.



## MyKey™ - Vehicles With: 12.3 Inch Screen

**Note:** If a phone is connected using Apple CarPlay or Android Auto while driving with a MyKey, the driver can receive phone calls and text messages even if the do not disturb restriction is on. And if the vehicle comes with satellite radio, there is no restriction on the adult content.

### Traction and Stability Control

If you set traction control or stability control to always on, you cannot switch it off with a MyKey.

### CREATING A MYKEY

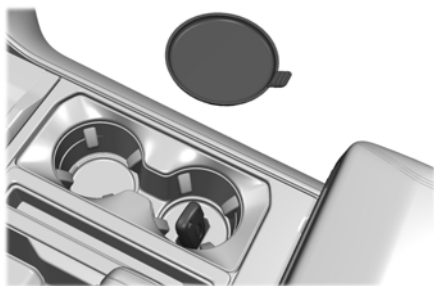

**Note:** Use these instructions to create a MyKey for a passive key or a mobile device.

1. Remove the mat from the center console cup holder.
2. Remove the key blade from the remote control.
3. Place the passive key in the backup slot with the buttons facing toward the rear of the vehicle.
4. Switch the ignition on using the key you want to create as MyKey.
5. Press **Settings** on the touchscreen.
6. Press **Vehicle Settings**.
7. Press **MyKey**.

8. Press **Create MyKey** or **Create MyKey Mobile Device**.
9. Press **Yes**.
10. Switch the ignition off.

**Note:** You successfully created a MyKey. We recommend that you label this key so you can distinguish it from the admin keys.

**Note:** You can use both a passive key and a mobile device as a MyKey. You must have a second passive key and create it as a MyKey.

**Note:** The programmed restrictions apply when you switch the vehicle off, open and close the driver door and restart your vehicle with the passive key or mobile device.

### PROGRAMMING A MYKEY

You can program any remote control to become a restricted MyKey, but you must leave one unmodified as an admin key.

1. Switch the ignition on using an admin key.
2. Press **Settings** on the touchscreen.
3. Press **Vehicle Settings**.
4. Press **MyKey**.
5. Select and configure the settings.

### CLEARING ALL MYKEYS

When you clear all MyKeys, you remove all restrictions and return all MyKeys to their original admin key status.

1. Switch the ignition on using an admin key.
2. Press **Settings** on the touchscreen.
3. Press **Vehicle Settings**.
4. Press **MyKey**.
5. Press **Clear All MyKeys**.
6. Press **Yes**.

# MyKey™ - Vehicles With: 12.3 Inch Screen

---

## CHECKING MYKEY SYSTEM STATUS

You can find information about the distance traveled using a MyKey, and the number of admin keys and MyKeys created for your vehicle.

1. Switch the ignition on.
2. Press **Settings** on the touchscreen.
3. Press **Vehicle Settings**.
4. Press **MyKey**.
5. Press **MyKey Information**.

## MYKEY – TROUBLESHOOTING

### MYKEY – INFORMATION MESSAGES

Message	Description
Place Key in Backup Location	Displays when trying to create a MyKey and the admin key is not placed in the backup position. See <b>Creating a MyKey</b> (page 77).
Key is Already a MyKey	Displays when trying to create a MyKey with a key already designated as a MyKey.
This Key restricted at Next Key Cycle. Label Key as MyKey	Displays to confirm that the key is restricted after you switch the ignition off.

## MYKEY – FREQUENTLY ASKED QUESTIONS

### What is an admin key?

An admin key is a key that you have not created as a MyKey. See **Creating a MyKey** (page 77).

### Why am I not able to create a MyKey?

The admin key is not placed in the backup position. See **Creating a MyKey** (page 77). The key used to switch the vehicle on is not an admin key. The key used to switch the vehicle on is the only admin key. There has to be at least one admin key. You did not switch the vehicle off after creating the last MyKey.

### Why am I not able to program a MyKey?

The admin key is not inside your vehicle. The key used to switch the vehicle on is not an admin key. No MyKeys are created. See **Creating a MyKey** (page 77).

### Why am I not able to clear the MyKeys?

The admin key is not inside your vehicle. The key used to switch the vehicle on is not an admin key. You have not created any MyKeys. See **Creating a MyKey** (page 77).

### Why is the MyKey distance not accumulating?

The key used to start the vehicle is an admin key. An admin key and a MyKey are inside your vehicle. No MyKeys are created. See **Creating a MyKey** (page 77). You have cleared the MyKeys.

### Why am I not able to start the vehicle with a MyKey?

An admin key and a MyKey are inside your vehicle. The system recognizes only the admin key when both are present.

# MyKey™ - Vehicles With: 15 Inch Screen

## WHAT IS MYKEY

MyKey allows you to program keys and mobile devices with restricted driving modes to promote good driving habits.

## MYKEY SETTINGS

### NON-CONFIGURABLE MYKEY SETTINGS

#### Seatbelt Reminder or Belt-Minder™

MyKey mutes the audio system until the front seat belts are buckled.

**Note:** *If your vehicle includes an AM/FM radio or a very basic audio system, then the radio may not mute.*

#### Satellite Radio (If Equipped)

Some Satellite radio channels have restricted access to adult radio content.

#### Driving and Parking Aids

Settings for parking aids, blind spot information system, and cross traffic alert cannot be configured. These systems turn on when the vehicle turns on and cannot be switched off with a MyKey.

Settings for pre-collision assist and lane keeping cannot be configured. These systems turn on when the vehicle turns on but can be switched off with a MyKey.

A new destination in the navigation system can only be set using voice commands when using a MyKey, and with your vehicle moving.

**Note:** *MyKey drivers may be able to turn the lane departure warning feature off, but this feature turns back on automatically with every new key cycle.*

## CONFIGURABLE MYKEY SETTINGS

You can configure the following settings after creating a MyKey. See **Creating a MyKey** (page 77).

### Speed Limit



**WARNING:** Do not set MyKey maximum speed limit to a limit that will prevent the driver from maintaining a safe speed considering posted speed limits and prevailing road conditions. The driver is always responsible to drive in accordance with local laws and prevailing conditions. Failure to do so could result in accident or injury.

You can set a speed limit for your vehicle. Warning messages appear on the touchscreen and a tone sounds if your vehicle reaches the set speed. You cannot override the set speed when using a MyKey.

### Speed Minder

You can set a speed reminder for your vehicle. Warning messages appear on the touchscreen and a tone sounds if your vehicle exceeds the set speed.

### Audio System Volume Limit

The audio system maximum volume reduces. A message appears on the touchscreen if you attempt to exceed the volume limit. Automatic volume control turns off.

### Emergency Assistance

If you set emergency assistance to always on, you cannot switch it off with a MyKey.

### Do Not Disturb

If you set do not disturb to always on, you cannot switch it off with a MyKey.

# MyKey™ - Vehicles With: 15 Inch Screen

**Note:** If a phone is connected using Apple CarPlay or Android Auto while driving with a MyKey, the driver can receive phone calls and text messages even if the do not disturb restriction is on. And if the vehicle comes with satellite radio, there is no restriction on the adult content.

## Traction and Stability Control

If you set traction control or stability control to always on, you cannot switch it off with a MyKey.

## CREATING A MYKEY

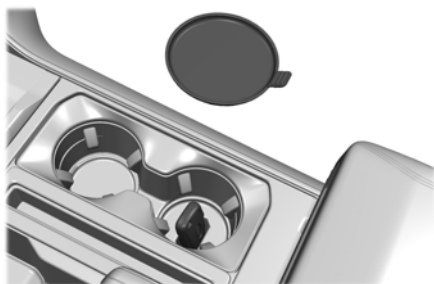

**Note:** Use these instructions to create a MyKey for a passive key or a mobile device.

1. Remove the mat from the center console cup holder.
2. Remove the key blade from the remote control.
3. Place the passive key in the position shown, with the buttons facing upward.
4. Switch the vehicle on.
5. Access the vehicle drawer on the touchscreen.
6. Press **SETTINGS**.
7. Press **Vehicle**.
8. Press **MyKey**.

9. Press **Create MyKey** or **Create MyKey Mobile Device**.

10. Press **Yes**.

**Note:** After you confirm the creation of a MyKey, we recommend that you label this key.

**Note:** You can use both a passive key and a mobile device as a MyKey. You must have a second passive key and create it as a MyKey.

## PROGRAMMING A MYKEY

You can program any remote control to become MyKey restricted but you must leave one unmodified as an admin key.

1. Switch the vehicle on using an admin key.
2. Access the vehicle drawer on the touchscreen.
3. Press **SETTINGS**.
4. Press **Vehicle**.
5. Press **MyKey**.
6. Select a setting and press the **OK** button.
7. Configure the setting.

## CLEARING ALL MYKEYS

When you clear all MyKeys, you remove all restrictions and return all MyKeys to their original admin key status.

1. Switch the vehicle on using an admin key.
2. Access the vehicle drawer on the touchscreen.
3. Press **SETTINGS**.
4. Press **Vehicle**.
5. Press **MyKey**.
6. Press **Clear All MyKeys**.

# MyKey™ - Vehicles With: 15 Inch Screen

---

7. Press **Yes**.

## CHECKING MYKEY SYSTEM STATUS

You can find information about the distance traveled using a MyKey, and the number of admin keys and MyKeys created for your vehicle.

1. Switch the vehicle on.
2. Access the vehicle drawer on the touchscreen.
3. Press **SETTINGS**.
4. Press **Vehicle**.
5. Press **MyKey**.
6. Press **MyKey Information**.

## MYKEY – TROUBLESHOOTING

### MYKEY – INFORMATION MESSAGES

Message	Description
Place Key in Backup Location	Displays when trying to create a MyKey and the admin key is not placed in the backup position. See <b>Creating a MyKey</b> (page 77).
Key is Already a MyKey	Displays when trying to create a MyKey with a key already designated as a MyKey.
This Key restricted at Next Key Cycle. Label Key as MyKey	Displays to confirm that the key is restricted after you switch the ignition off.

# MyKey™ - Vehicles With: 15 Inch Screen

---

## MYKEY – FREQUENTLY ASKED QUESTIONS

### What is an admin key?

An admin key is a key that you have not created as a MyKey. See **Creating a MyKey** (page 77).

### Why am I not able to create a MyKey?

The admin key is not placed in the backup position. See **Creating a MyKey** (page 77). The key used to switch the vehicle on is not an admin key. The key used to switch the vehicle on is the only admin key. There has to be at least one admin key. You did not switch the vehicle off after creating the last MyKey.

### Why am I not able to program a MyKey?

The admin key is not inside your vehicle. The key used to switch the vehicle on is not an admin key. No MyKeys are created. See **Creating a MyKey** (page 77).

### Why am I not able to clear the MyKeys?

The admin key is not inside your vehicle. The key used to switch the vehicle on is not an admin key. You have not created any MyKeys. See **Creating a MyKey** (page 77).

### Why is the MyKey distance not accumulating?

The key used to start the vehicle is an admin key. An admin key and a MyKey are inside your vehicle. No MyKeys are created. See **Creating a MyKey** (page 77). You have cleared the MyKeys.

### Why am I not able to start the vehicle with a MyKey?

An admin key and a MyKey are inside your vehicle. The system recognizes only the admin key when both are present.

# Doors and Locks

## OPERATING THE DOORS FROM OUTSIDE YOUR VEHICLE

### UNLOCKING AND LOCKING THE DOORS USING THE REMOTE CONTROL (If Equipped)

You can only use the remote control when your vehicle is stationary.

#### Unlocking the Doors



Press the button to unlock all doors.

#### Locking the Doors



Press the button to lock all doors. One short flash of the turn signal lamps confirms that your vehicle has locked.

**Note:** For more information on operating the doors from outside your vehicle

### UNLOCKING AND LOCKING THE DOORS USING THE KEY BLADE

If there is a power door lock fault you can use the key blade to lock and unlock the doors.

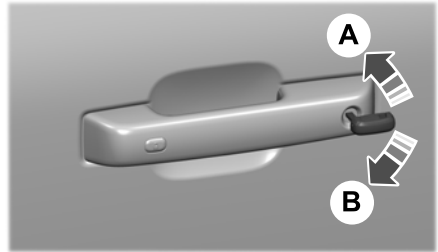

- A Lock.
- B Unlock.

## OPERATING THE DOORS FROM INSIDE YOUR VEHICLE

### INDIVIDUALLY UNLOCKING AND LOCKING THE DOORS USING THE LOCKING BUTTON

The power door lock control is on the driver and front passenger door panels.

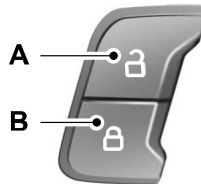

- A Unlock.
- B Lock.



# Doors and Locks

---

## OPENING THE DOORS FROM INSIDE YOUR VEHICLE - CREW CAB

Pull the interior door handle twice to unlock and open a rear door. The first pull unlocks the door and the second pull opens the door.

## AUTOUNLOCK (IF EQUIPPED)

### WHAT IS AUTOUNLOCK

Autounlock is an unlocking feature that unlocks the vehicle doors when your vehicle comes to a stop.

### AUTOUNLOCK REQUIREMENTS

Autounlock unlocks all the doors when all of the following occur:

- Your vehicle comes to a stop.
- You open the driver door within 10 minutes of switching the ignition off or to the accessory position.

## SWITCHING AUTOUNLOCK ON AND OFF - VEHICLES WITH: 12.3 INCH SCREEN

1. Press **Settings** on the touchscreen.
2. Press **Vehicle Settings**.
3. Switch **Autounlock** on or off.

## SWITCHING AUTOUNLOCK ON AND OFF - VEHICLES WITH: 15 INCH SCREEN

1. Access the vehicle drawer on the touchscreen.
2. Press **SETTINGS**.
3. Press **Vehicle**.
4. Press **Locks**.

5. Switch **Autounlock** on or off.

## AUTOLOCK (IF EQUIPPED)

### WHAT IS AUTOLOCK

Autolock is a locking feature that locks your vehicle doors when you start driving.

### AUTOLOCK REQUIREMENTS

Autolock locks all the doors when all of the following occur:

- All doors are closed.
- The ignition is on.
- Your vehicle reaches a speed greater than 12 mph (20 km/h).

## MISLOCK (IF EQUIPPED)

### WHAT IS MISLOCK

Mislock is a locking feature that warns you if your vehicle has not locked.

### MISLOCK LIMITATIONS

When you press the lock button once, the turn signals do not flash if:

- Any door or the tailgate is open.
- The hood is open.

If you switch mislock off, the horn does not sound if you press the lock button on the remote control when a door is open.

## SWITCHING MISLOCK ON AND OFF - VEHICLES WITH: 12.3 INCH SCREEN

1. Press **Settings** on the touchscreen.
2. Press **Vehicle Settings**.
3. Switch **Mislock Chirp** on or off.

# Doors and Locks

## SWITCHING MISLOCK ON AND OFF - VEHICLES WITH: 15 INCH SCREEN

1. Access the vehicle drawer on the touchscreen.
2. Press **SETTINGS**.
3. Press **Vehicle**.
4. Press **Locks**.
5. Switch **Mislock** on or off.

## DOORS AND LOCKS AUDIBLE WARNINGS

### Door Ajar Audible Warning

Sounds when a door is not fully closed and your vehicle is moving.

## DOORS AND LOCKS – INFORMATION MESSAGES

Message	Action
Driver Door Ajar	Displays if a door is open. Fully close the door.
Passenger Door Ajar	
Rear Left Door Ajar	
Rear Right Door Ajar	
Hood Ajar	Displays if a hood is open. Fully close the hood.

## DOORS AND LOCKS – TROUBLESHOOTING

### DOORS AND LOCKS – WARNING LAMPS

#### Door Ajar Warning Lamp



Illuminates when you switch the ignition on and remains on if any door or the hood is open.

# Doors and Locks

---

## **DOORS AND LOCKS – FREQUENTLY ASKED QUESTIONS**

### **Can accessories such as steps or handles be used with the latch assembly?**

Do not use the door latch assembly to attach any accessory, such as handles or steps, as this can cause damage to your vehicle.

# Keyless Entry (If Equipped)

## KEYLESS ENTRY LIMITATIONS

Make sure your remote control is within 3 ft (1 m) from the front door handles and the tailgate.

The system could not function if:

- The remote control remains stationary for about a minute.
- The vehicle battery has no charge.
- The remote control battery has no charge.
- There is interference causing issues with the remote control frequencies.
- The remote control is too close to metal objects or electronic devices, for example keys or a cell phone.

## KEYLESS ENTRY SETTINGS

### Switching Keyless Entry On and Off

1. Switch the ignition on using an original key that has not been created as a MyKey.
2. Press **Settings** on the touchscreen.
3. Press **Vehicle Settings**.
4. Press **Locks**.

### Reprogramming the Unlocking Function

You can enable two-stage unlocking function allowing you to unlock only the driver door when you touch the unlock sensor.

Press and hold both the lock and unlock buttons on the remote control for four seconds to disable or enable two-stage unlocking.

If you program the unlocking function so that only the driver door unlocks, you can unlock all of the other doors from inside your vehicle using the power door lock control. You can unlock individual doors by pulling the interior door handles on those doors.

## USING KEYLESS ENTRY

### Unlocking the Doors



With your passive key within 3 ft (1 m) of your vehicle, touch the unlock sensor on the back of the door handle for a brief period and then pull on the door handle to unlock, being careful not to touch the lock sensor at the same time or pull on the door handle too quickly. The intelligent access system requires a brief delay to authenticate your passive key.

### Locking the Doors



With your passive key within 3 ft (1 m) of your vehicle, touch the outer door handle lock sensor for approximately one second to lock, being careful not to touch the unlock sensor on the back of the door handle at the same time. After locking, you can immediately pull on the door handle to confirm locking occurred without inadvertently unlocking.

# Keyless Entry Keypad (If Equipped)

## WHAT IS THE KEYLESS ENTRY KEYPAD

The keyless entry keypad allows you to lock and unlock your vehicle using the keypad on the window trim.

## KEYLESS ENTRY KEYPAD LIMITATIONS

The system may not function if:

- The vehicle battery has no charge.

## LOCATING THE KEYLESS ENTRY KEYPAD

The keypad is near the driver window and illuminates when you touch it.



## KEYLESS ENTRY KEYPAD MASTER ACCESS CODE

### What Is the Master Access Code

The master access code is a factory-set five-digit entry code. You can operate the keypad with the master access code at any time. The master access code is on the owner's wallet card in the glove box and is available from an authorized dealer.

## KEYLESS ENTRY KEYPAD PERSONAL ACCESS CODES

### Programming a Personal Entry Code

1. Enter the five-digit master code.
2. Press **1-2** on the keypad within five seconds.
3. Enter your personal five-digit code. You must do this within five seconds of completing Step 2.
4. Press **1-2** on the keypad to save personal code 1.

The doors lock then unlock to confirm that programming was successful.

To program additional personal entry codes, repeat Steps 1 through 3, then for Step 4:

- Press **3-4** to save personal code 2.
- Press **5-6** to save personal code 3.
- Press **7-8** to save personal code 4.
- Press **9-0** to save personal code 5.

If your vehicle comes with SYNC, you can also program the system with a personal entry code.

Hints:

- Do not set a code that uses five of the same number.
- Do not use five numbers in sequential order.
- The five-digit master code works even if you have set your own personal code.

### Erasing a Personal Code

1. Enter the five-digit master code.
2. Press and release **1-2** on the keypad within five seconds.
3. Press and hold **1-2** for two seconds. You must do this within five seconds of completing Step 2.

## Keyless Entry Keypad (If Equipped)

All personal codes erase and only the five-digit master code works.

### Anti-Scan Feature

The keypad goes into an anti-scan mode if you enter the wrong code seven times. This mode turns off the keypad for one minute and the keypad lamp flashes.

The anti-scan feature turns off after:

- One minute of keypad inactivity.
- You press the unlock button on the remote control.
- You switch the ignition on.
- You unlock your vehicle using keyless entry.

## USING THE KEYLESS ENTRY KEYPAD

### Unlocking the Doors



Enter the factory-set five-digit code or your personal code. You must press each number within five seconds of each other.

- Press 3-4 within five seconds to unlock all doors.

### To Release the Tailgate

Enter the factory-set five-digit code or your personal code, then press 5-6 within five seconds.

### To Release the Frunk

Enter the factory-set five-digit code or your personal code, then press 7-8 within five seconds.

### Locking the Doors



Press and hold **7-8** and **9-0** at the same time with the driver door closed.

**Note:** You do not need to enter the code first.

## KEYLESS ENTRY KEYPAD – TROUBLESHOOTING

### KEYLESS ENTRY KEYPAD – FREQUENTLY ASKED QUESTIONS

#### Why does the keypad not accept the access code?

If you enter the access code too fast on the keypad, the unlock function may not work. Slowly re-enter the access code.

#### Why does the keypad not function?

The keypad goes into an anti-scan mode if you enter a wrong code seven times. The anti-scan mode disables the keypad for one minute and the red light flashes.

## Easy Entry and Exit (If Equipped)

---

### HOW DOES EASY ENTRY AND EXIT WORK

Easy entry and exit moves the driver seat rearward up to 2 in (5 cm) and may move the steering column up and in when you switch the ignition off. The driver seat and steering column return to their previous positions when you switch the ignition on.

### SWITCHING EASY ENTRY AND EXIT ON AND OFF

1. Press **Settings** on the touchscreen.
2. Press **Vehicle**.
3. Select **Easy Entry/Exit**.

If you press any adjustment or memory button when in easy exit mode, the system cancels the operation.

# Tailgate - Vehicles With: Manual Tailgate

## TAILGATE PRECAUTIONS

**WARNING:** It is extremely dangerous to ride in a cargo area, inside or outside of a vehicle. In a crash, people riding in these areas are more likely to be seriously injured or killed. Do not allow people to ride in any area of your vehicle that is not equipped with seats and seatbelts. Make sure everyone in your vehicle is in a seat and properly using a seatbelt. Failure to follow this warning could result in serious personal injury or death.

## OPENING THE TAILGATE

### OPENING THE TAILGATE FROM OUTSIDE YOUR VEHICLE

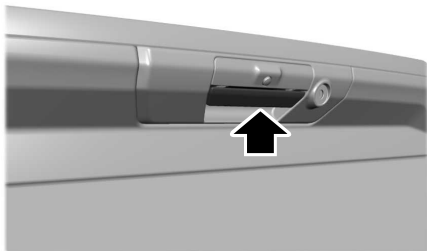

Pull up on the handle to release the tailgate.

**Note:** You may need to unlock the tailgate first.

## REMOVING AND INSTALLING THE TAILGATE

**WARNING:** Always properly secure cargo to prevent shifting cargo or cargo falling from the vehicle. Failure to do so could result in compromised vehicle stability and serious personal injury to vehicle occupants or others.

**Note:** Skip to Step 4 if your vehicle does not have power door locks.

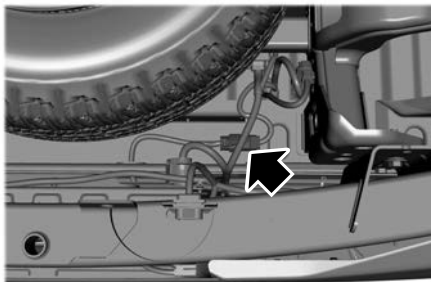

1. Unlatch the tailgate.
2. Disconnect the power door locks in-line connector. It is under the pickup box on the right-hand side of the vehicle near the spare tire.
3. Install a protective cap on the in-line connector portion that remains under the pickup box.

**Note:** A protective cap should be in the glove compartment.

4. Partially lower the tailgate. Carefully feed the tailgate harness up through the gap between the pickup box and the bumper and place it out of the way under the pickup box.
5. Lower the tailgate.



## Tailgate - Vehicles With: Manual Tailgate

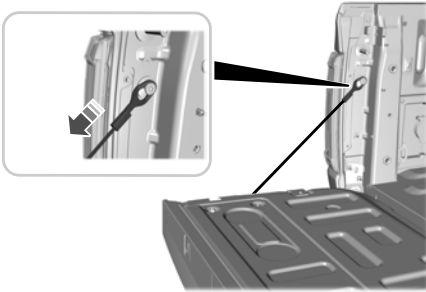

6. Use a screwdriver to gently pry the spring clip on each connector past the head of the support screw. Disconnect the cable.
  7. Disconnect the other cable.
- Note:** To avoid damaging the tailgate, you may need assistance when removing. The tailgate weighs approximately 97 lb (44 kg).
8. Lift the tailgate to 45 degrees from the horizontal position.
  9. Lift the right-hand side off its hinge.
  10. Lift the tailgate to 80 degrees from the horizontal position.
  11. Remove the tailgate from the left-hand side hinge by sliding it to the right.
  12. Install the tailgate in reverse order.

### **TAILGATE STEP (IF EQUIPPED)**

#### **ACCESSING THE TAILGATE STEP**

1. Lower the tailgate.
2. Push the button in the center of the step molding. The step pops out slightly.

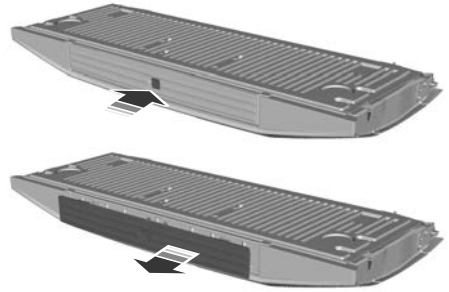

3. Pull the step out fully. Lower the step to its lowest position.



4. Pull the yellow handle stop backward out of the tailgate until it fully extends.
5. To lock the handle in place, rotate the handle up from the horizontal to the vertical position until you hear a click.

**Note:** Do not tow with the step or grab handle.

Replace the slip resistance tape or grab handle molding if it appears as worn or damaged.

To reduce the risk of falling:

- Only operate the step when your vehicle is on a level surface.
- Only operate the step in areas with sufficient lighting.

## Tailgate - Vehicles With: Manual Tailgate

- Make sure you use the grab handle when climbing on the step.
- Do not use the step with bare feet.
- Make sure the step is clean before use.
- Keep the step load below the total maximum load of 350 lb (159 kg).

### STOWING THE TAILGATE STEP

1. Press the yellow button on the handle to lower and then press the yellow lever at the bottom of the handle to unlock. Rotate the handle down from the vertical to the horizontal position and push it into the tailgate.
2. Rotate the step up until it is horizontal, then push it back into the tailgate until the step is secure.

**Note:** Make sure to close and fully latch the step before moving your vehicle. Do not drive with the step or grab handle open.

**Note:** The power tailgate cannot close if the step is opened. A warning message appears and a chime sounds. After stowing step the power close function is restored.

### TAILGATE WORK SURFACE (IF EQUIPPED)

The tailgate work surface is a durable and functional surface on the inside portion of your tailgate you can use to perform various tasks.

To use the tailgate work surface, fold down the tailgate.

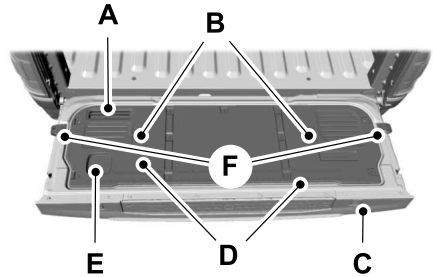

- A Tablet stand.
- B Tool inset.
- C Clamp pocket.
- D Standard and metric ruler.
- E Cup holder.
- F Tailgate anchors.

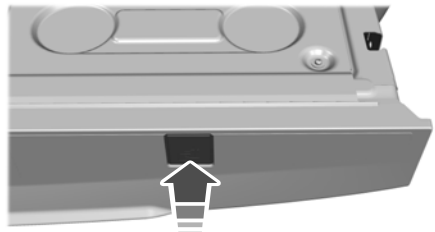

The tailgate work surface contains clamp pockets that allows you to secure work material.

**Note:** Damage could occur to the tailgate if you overload the vertical clamp arm in any direction.

**Note:** When you finish using the tailgate work surface, make sure you remove all of your belongings, then close the tailgate.

# Tailgate - Vehicles With: Power Tailgate

## TAILGATE PRECAUTIONS



**WARNING:** It is extremely dangerous to ride in a cargo area, inside or outside of a vehicle. In a crash, people riding in these areas are more likely to be seriously injured or killed. Do not allow people to ride in any area of your vehicle that is not equipped with seats and seatbelts. Make sure everyone in your vehicle is in a seat and properly using a seatbelt. Failure to follow this warning could result in serious personal injury or death.

## OPENING THE TAILGATE

### OPENING THE TAILGATE FROM INSIDE YOUR VEHICLE

The vehicle must be in park (P) to operate the power tailgate.



Press the button on the instrument panel.

**Note:** A tone sounds while the tailgate opens.

**Note:** The tailgate stops and reverses if it detects an obstruction when opening.

**Note:** An alert sounds if the electronic tailgate is in manual mode.

**Note:** A pop-up message appears on the touchscreen if the tailgate is in manual mode asking if you want to change back to power mode.

### OPENING THE TAILGATE FROM OUTSIDE YOUR VEHICLE

1. Unlock the vehicle with the remote control, power door unlock control or your phone as a key device.

**Note:** If an authorized device is within 3 ft (1 m) of the tailgate, the tailgate unlocks when you press the tailgate release button.

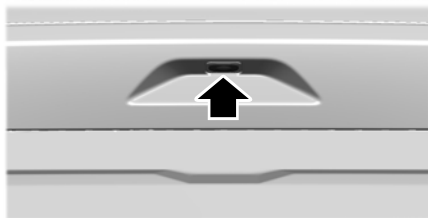

2. Press the button on the middle of the tailgate.

### OPENING THE TAILGATE USING THE REMOTE CONTROL



Press the remote control button twice within three seconds.

## CLOSING THE TAILGATE

### CLOSING THE TAILGATE FROM INSIDE YOUR VEHICLE



Press the button on the instrument panel.

**Note:** The tailgate stops and reverses if it detects an obstruction when closing.

### CLOSING THE TAILGATE FROM OUTSIDE YOUR VEHICLE

You can close the power tailgate by:

- Pressing the tailgate button on your remote control twice within three seconds.
- Pressing the button on the instrument panel.

# Tailgate - Vehicles With: Power Tailgate

- Pressing the button on the tailgate.
- Pressing power tailgate button on the phone as a key device for two seconds.

**Note:** A tone sounds while the tailgate closes.

**Note:** The tailgate stops and reverses if it detects an obstruction when closing.

## Lift-to-Close

To close the tailgate automatically using lift-to-close, lift the tailgate approximately 4 in (10 cm) and hold it for a few seconds.

**Note:** If the tailgate position is more than halfway open, it may not close automatically.

## Manual Close

You can close the tailgate manually when you lift the tailgate in a continuous motion.

If you stop the tailgate motion, the lift-to-close feature engages and power closes the tailgate.

## Putting the Tailgate in Manual Mode

You can put the tailgate in manual mode through the vehicle settings in your touchscreen.

**Note:** In manual mode, the tailgate only opens by the tailgate release button on the tailgate and messaging is reduced.

**Note:** A pop-up message appears on the touchscreen if the tailgate is in manual mode asking if you want to change back to power mode.

## CLOSING THE TAILGATE USING THE REMOTE CONTROL



Press the remote control button twice within three seconds.

## REMOVING AND INSTALLING THE TAILGATE



**WARNING:** Always properly secure cargo to prevent shifting cargo or cargo falling from the vehicle. Failure to do so could result in compromised vehicle stability and serious personal injury to vehicle occupants or others.

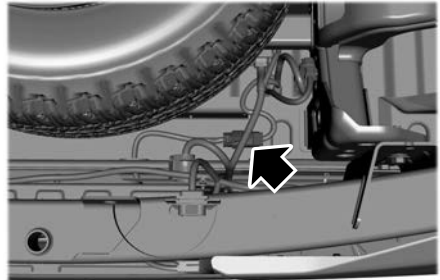

1. Put the tailgate into manual mode by accessing the vehicle settings using the touchscreen.
2. Open the tailgate.
3. Disconnect the power door locks in-line connector located under the pickup box on the right-hand side of the vehicle near the spare tire.
4. Install the protective cap on the in-line connector portion that remains under the pickup box.

**Note:** The protective cap is in the glove compartment.

5. Partially raise the tailgate. Carefully feed the tailgate harness up through the gap between the pickup box and the bumper and place it out of the way under the pickup box.
6. Fully lower the tailgate.

## Tailgate - Vehicles With: Power Tailgate

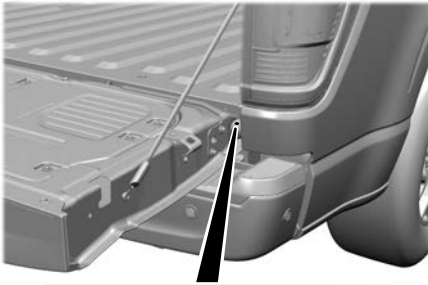

10. Lift the tailgate to 45 degrees from the horizontal position.
11. Lift the right-hand side off its hinge.
12. Lift the tailgate to 80 degrees from the horizontal position.
13. Remove the tailgate from the left-hand side hinge by sliding it to the right.
14. Install the tailgate in reverse order.

**Note:** After reinstalling the tailgate it is important to reinstall the retaining screw to the recommended torque, 7 lb.ft (10 Nm). Failure to install the retaining screw can cause the tailgate to detach.

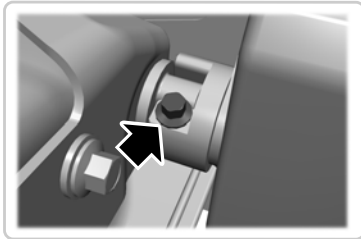

7. Remove the retaining screw.

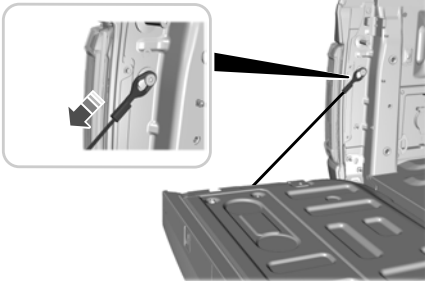

8. Use a screwdriver to gently pry the spring clip on each connector past the head of the support screw. Disconnect the cable.
9. Disconnect the other cable.

**Note:** To avoid damaging the tailgate, you may need assistance when removing. The tailgate weighs approximately 101 lb (46 kg).

### TAILGATE STEP (IF EQUIPPED)

#### ACCESSING THE TAILGATE STEP

1. Lower the tailgate.
2. Push the button in the center of the step molding. The step pops out slightly.

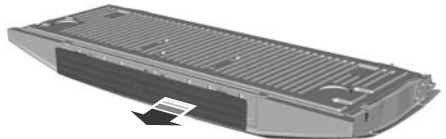

3. Pull the step out fully. Lower the step to its lowest position.

## Tailgate - Vehicles With: Power Tailgate

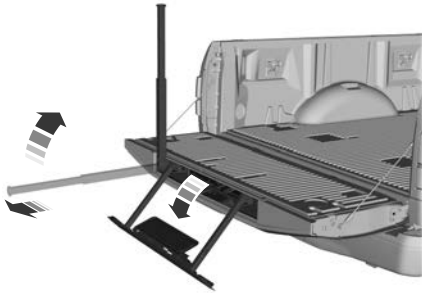

4. Pull the yellow handle stop backward out of the tailgate until it fully extends.
5. To lock the handle in place, rotate the handle up from the horizontal to the vertical position until you hear a click.

**Note:** Do not tow with the step or grab handle.

Replace the slip resistance tape or grab handle molding if it appears as worn or damaged.

To reduce the risk of falling:

- Only operate the step when your vehicle is on a level surface.
- Only operate the step in areas with sufficient lighting.
- Make sure you use the grab handle when climbing on the step.
- Do not use the step with bare feet.
- Make sure the step is clean before use.
- Keep the step load below the total maximum load of 350 lb (159 kg).

### STOWING THE TAILGATE STEP

1. Press the yellow button on the handle to lower and then press the yellow lever at the bottom of the handle to unlock. Rotate the handle down from the vertical to the horizontal position and push it into the tailgate.

2. Rotate the step up until it is horizontal, then push it back into the tailgate until the step is secure.

**Note:** Make sure to close and fully latch the step before moving your vehicle. Do not drive with the step or grab handle open.

**Note:** The power tailgate cannot close if the step is opened. A warning message appears and a chime sounds. After stowing step the power close function is restored.

### TAILGATE WORK SURFACE

The tailgate work surface is a durable and functional surface on the inside portion of your tailgate you can use to perform various tasks.

To use the tailgate work surface, fold down the tailgate.

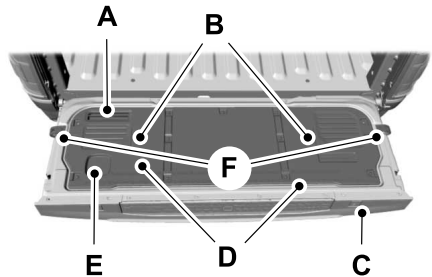

- A Tablet stand.
- B Tool inset.
- C Clamp pocket.
- D Standard and metric ruler.
- E Cup holder.
- F Tailgate anchors.

## Tailgate - Vehicles With: Power Tailgate

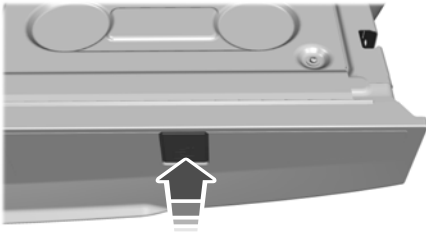

The tailgate work surface contains clamp pockets that allows you to secure work material.

**Note:** *Damage could occur to the tailgate if you overload the vertical clamp arm in any direction.*

**Note:** *When you finish using the tailgate work surface, make sure you remove all of your belongings, then close the tailgate.*

### TAILGATE – TROUBLESHOOTING

#### TAILGATE – INFORMATION MESSAGES

Message	Action
Tailgate Ajar	The tailgate is not completely closed.
Power Tailgate Stow Step	You need to stow the tailgate step before the power tailgate can close.

# Tailgate - Vehicles With: Power Tailgate

---

## **TAILGATE – FREQUENTLY ASKED QUESTIONS**

### **Why won't my power tailgate open?**

Make sure the tailgate is in power mode. Make sure the vehicle is in park (P), ensure nothing is obstructing the tailgate path and or causing resistance (tonneau cover or other aftermarket accessory, freezing conditions or being parked downhill). If you have continued issues, the battery voltage may be low or other system issues. See an authorized dealer.

### **Why won't my power tailgate close?**

Make sure the tailgate is in power mode. Your vehicle speed is at or above 2.5 mph (4 km/h), the tailgate encountered an obstacle or freezing conditions. After removing the obstacles, manually close the tailgate to resume normal operation. If you have continued issues, the battery voltage may be low or other system issues. See an authorized dealer.



# Security

---

## PASSIVE ANTI-THEFT SYSTEM

### WHAT IS THE PASSIVE ANTI-THEFT SYSTEM

The passive anti-theft system prevents someone from starting the vehicle with an incorrectly coded key.

**Note:** *Do not leave a duplicate coded key in your vehicle. Always take the keys and lock all the doors when leaving your vehicle.*

### HOW DOES THE PASSIVE ANTI-THEFT SYSTEM WORK

The passive anti-theft system arms when you switch the ignition off.

It disarms when the ignition is switched on with a correctly coded key.

**Note:** *The system is not compatible with non-Ford aftermarket remote start systems.*

**Note:** *Do not leave a duplicate coded key in your vehicle. Always take the keys and lock all doors when leaving your vehicle.*

## ANTI-THEFT ALARM SYSTEM

(IF EQUIPPED)

### WHAT IS THE ANTI-THEFT ALARM SYSTEM

The Anti-Theft Alarm System warns you of an unauthorized entry to your vehicle.

## HOW DOES THE ANTI-THEFT ALARM SYSTEM WORK

When armed, the anti-theft alarm is triggered in any of the following ways:

- If someone opens a door, the tailgate or the hood without a correctly coded key or remote control.
- If you turn the power on without a correctly coded key.
- If the interior sensors detect movement inside your vehicle.
- If the inclination sensors detect an attempt to raise your vehicle.
- If someone disconnects the vehicle battery or the battery backup alarm.
- If someone disconnects the trailer. See **Connecting a Trailer** (page 348).

Any further attempts to carry out one of the above, sounds the alarm again.

If the anti-theft alarm is triggered, the alarm horn sounds for 30 seconds and the turn signals flash for five minutes.

## WHAT IS THE PERIMETER ALARM

The perimeter alarm is designed to detect unauthorized access to your vehicle.

## WHAT ARE THE INTERIOR SENSORS (If Equipped)

The interior sensors are designed to detect any movement inside your vehicle.

The interior sensors are in the overhead console.

**Note:** *Do not cover the interior sensors.*

# Security

---

## WHAT ARE THE INCLINATION SENSORS (If Equipped)

The inclination sensor is designed to detect an attempt to raise your vehicle, for example to remove a wheel or to tow it away.

## WHAT IS THE BATTERY BACKUP ALARM

The battery backup alarm is an additional alarm sounder that has its own battery. It can detect if the vehicle battery is disconnected to overcome the alarm system.

## ARMING THE ANTI-THEFT ALARM SYSTEM

The alarm is ready to arm when your vehicle is switched off.

Lock your vehicle with your remote control to arm the alarm.

## DISARMING THE ANTI-THEFT ALARM SYSTEM

Disarm the alarm by performing any of the following actions:

- Unlock the doors or luggage compartment with the remote control.
- Switch your vehicle on or start your vehicle.

## ANTI-THEFT ALARM SYSTEM SETTINGS (IF EQUIPPED)

## WHAT ARE THE ALARM SECURITY LEVELS

You can select two levels of alarm security, all sensors and perimeter sensing.

## All Sensors

All sensors is the standard setting.

In all sensors, all equipped sensors are on when you arm the alarm.

**Note:** *Do not arm the alarm with all sensors if passengers, animals or other moving objects are inside your vehicle.*

## Perimeter Sensing

In perimeter sensing, the interior sensors are off when you arm the alarm.

All the other equipped sensors activate when you arm the alarm in this mode.

## SETTING THE ALARM SECURITY LEVEL

1. Press **Settings** on the touchscreen.
2. Press **Vehicle**.
3. Press **Alarm System**.
4. Press **Motion Sensors**.
5. Press a setting.

## WHAT IS ASK ON EXIT

You can choose which level of security you require after you switch the ignition off.

**Note:** *If you do not choose a setting, the system defaults to all sensors.*

## SWITCHING ASK ON EXIT ON AND OFF

1. Press **Settings** on the touchscreen.
2. Press **Vehicle**.
3. Press **Alarm System**.
4. Switch **Ask on Exit** on or off.

# Security

---

## SECURITY – TROUBLESHOOTING

### SECURITY – INFORMATION MESSAGES

<b>Message</b>	<b>Details</b>
No Key Detected	The system has not detected a correctly coded key.
Starting System Fault	The system has malfunctioned. Have your vehicle checked as soon as possible.
Vehicle Alarm To Stop Alarm, Start Vehicle.	Displays when the alarm has been triggered due to unauthorized entry.
Alarm Announcement	

# Security

---

## **SECURITY – FREQUENTLY ASKED QUESTIONS**

### **What should I do if there is any potential alarm problem with my vehicle?**

Take all remote controls to an authorized dealer if there is any potential alarm problem with your vehicle.

### **What should I do if the vehicle is unable to start with a correctly coded key?**

Have your vehicle checked as soon as possible.

# Power Running Boards (If Equipped)

## POWER RUNNING BOARD PRECAUTIONS



**WARNING:** In extreme climates, excessive ice buildup may occur, causing the running boards not to deploy. Make sure that the running boards have deployed, and have finished moving before attempting to step on them. The running boards will resume normal function once the blockage is cleared.



**WARNING:** Switch off the running boards before jacking or placing any object under your vehicle. Never place your hand between the extended running board and your vehicle. A moving running board may cause injury.

Do not use the running boards, front and rear hinge assemblies, running board motors, or the running board underbody mounts to lift your vehicle when jacking. Use proper jacking points.

The running boards could move slower in cold temperatures.

## POWER RUNNING BOARD SETTINGS

1. Access the vehicle drawer on the touchscreen.
2. Press **SETTINGS**.
3. Press **Power Running Board**.
4. Press a setting.

### Running Boards (Modes)

#### Off

The power running boards remain stowed, regardless of door position.

#### Auto

The power running boards deploy when you approach your vehicle with a remote control, unlock the door or open the door.

The power running boards stow:

- After a few seconds when you close the doors.
- If you unlock the door but do not open it.
- If you have switched **Approach detection** on and do not open a door before the **Auto Timer** setting expires.

**Note:** When you select this mode, an option displays that allows you to select how long the running boards stay deployed without opening the door.

#### Out

The power running boards remain deployed, regardless of door position. The power running boards stow when the vehicle speed is more than 3 mph (5 km/h), and the mode changes to **Auto**. You need to select **Out** mode again if you want the power running boards to stay deployed at the end of each trip.

#### Approach detection

When you switch **Approach detection** on with **Auto** switched on, the running boards deploy when you approach your vehicle with a remote control.

## POWER RUNNING BOARD KICK SWITCH

You can use the power running board kick switch to deploy and stow the running board without opening or closing the door.

## Power Running Boards (If Equipped)

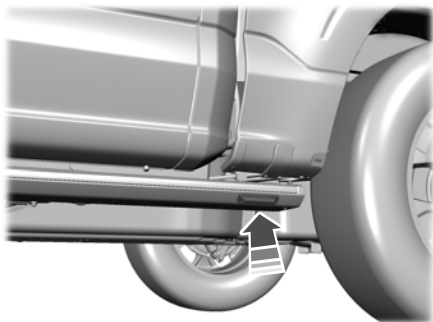

Press the switch with your foot to use the power running board kick switch.

Pressing the kick switch with the power running boards stowed switches the mode to **Out**.

Pressing the kick switch with the power running boards deployed switches the mode to **Auto**.

**Note:** When you use the kick switch, the power running board mode changes until you press the kick switch again.

You can change the kick switch setting on the touchscreen. See **Power Running Board Settings** (page 105).

### **Kick switch**

#### **Always active**

The kick switch is on regardless of whether the doors are locked or unlocked.

#### **Only while unlocked**

The kick switch is on only with the doors unlocked.

## **DEPLOYING AND STOWING THE POWER RUNNING BOARDS**

The power running boards deploy when you approach your vehicle with a remote control, unlock the door or open the door.

The power running boards stow:

- After a few seconds when you close the doors.
- If you unlock the door but do not open it.
- If you have switched **Approach detection** on and do not open a door before the **Auto Timer** setting expires. See **Power Running Board Settings** (page 105).

**Note:** The power running boards reverse direction and move to the end of travel if they encounter an object when moving.

## **POWER RUNNING BOARDS – TROUBLESHOOTING**

### **POWER RUNNING BOARDS – FREQUENTLY ASKED QUESTIONS**

#### **Why is there unwanted noise coming from my power running boards?**

The power running board mechanism could trap debris such as mud, dirt, snow, ice and salt. If this happens, set the running boards to the deployed position. Then, wash the system, in particular the front and rear hinge arms, with a high-pressure car wash wand.

# Steering Wheel

## ADJUSTING THE STEERING WHEEL - VEHICLES WITH: MANUAL ADJUSTABLE STEERING COLUMN

**WARNING:** Do not adjust the steering wheel when your vehicle is moving.

**Note:** Make sure that you are sitting in the correct position. See **Sitting in the Correct Position** (page 162).

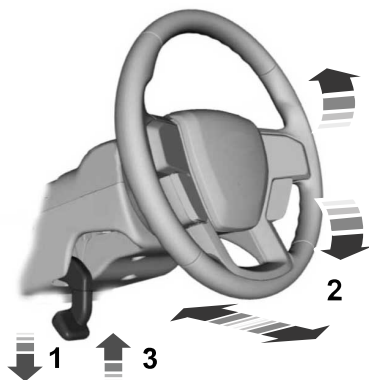

1. Unlock the steering column.
2. Adjust the steering wheel to the position you prefer.
3. Lock the steering column.

## ADJUSTING THE STEERING WHEEL - VEHICLES WITH: POWER ADJUSTABLE STEERING COLUMN

**WARNING:** Do not adjust the steering wheel when your vehicle is moving.

**Note:** Make sure that you are sitting in the correct position. See **Sitting in the Correct Position** (page 162).



Press the top or bottom of the control to move the steering wheel up or down.

Press the front or rear of the control to move the steering wheel in or out.

You can save and recall the steering wheel position with the memory function. See **Recalling a Preset Position** (page 176).

# Steering Wheel

---

## RESETTING THE STOPPING POSITION - VEHICLES WITH: POWER ADJUSTABLE STEERING COLUMN

**Note:** The steering wheel stops when it detects an obstruction. This sets a new stopping position.

To reset the steering column to its normal stopping position:

1. Confirm there is nothing obstructing the motion of the steering column.
2. Press and hold the steering column control until the steering column stops moving.
3. Press the steering column control again.

**Note:** The steering column may start to move again.

4. When the steering column stops, continue holding the control for a few seconds.
5. Repeat for each direction, as necessary.

## HORN



Press on the center of the steering wheel near the horn icon to activate the horn.

## SWITCHING THE HEATED STEERING WHEEL ON AND OFF - VEHICLES WITH: 12.3 INCH SCREEN (IF EQUIPPED)



To activate the heated steering wheel, press the button on the climate control unit.

On some vehicles, an indicator on the button illuminates when the heated steering wheel is on.

**Note:** A sensor regulates the temperature of the steering wheel.

## SWITCHING THE HEATED STEERING WHEEL ON AND OFF - VEHICLES WITH: 15 INCH SCREEN (IF EQUIPPED)



To switch the heated steering wheel on or off, press the button on the touchscreen near the climate controls.

**Note:** A sensor regulates the temperature of the steering wheel.



## Adjustable Pedals (If Equipped)

---

### ADJUSTING THE PEDALS



**WARNING:** Do not use the pedal adjustment controls when the vehicle is moving. Failure to follow this instruction could result in personal injury or death.

Your control is on the left-hand side of the steering column or on the instrument panel.

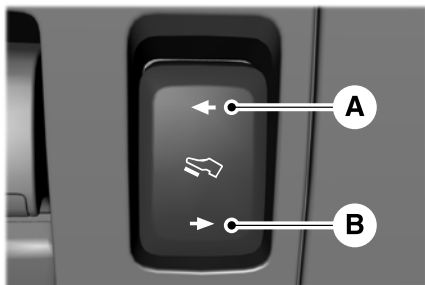

- A. Farther away from you.
- B. Closer to you.

You can save and recall the pedal positions with the memory feature. See **Memory Function** (page 176).

# Wipers and Washers

## WIPERS

### WIPER PRECAUTIONS

Do not operate the wipers on a dry windshield. This could scratch the glass or damage the wiper blades. Use the windshield washers before wiping a dry windshield.

Fully defrost the windshield before you switch the windshield wipers on.

Switch the windshield wipers off before entering a car wash.

### SWITCHING WINDSHIELD WIPERS ON AND OFF

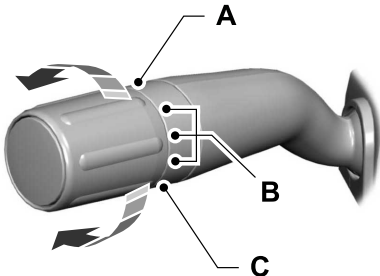

- A High-speed wipe.
- B Intermittent wipe.
- C Off.



Use the rotary control.

## AUTOWIPERS

### WHAT ARE AUTOWIPERS

Autowipers turns on and controls the speed and frequency of the windshield wipers.

### AUTOWIPERS SETTINGS - VEHICLES WITH: 12.3 INCH SCREEN

1. Press **Settings** on the touchscreen.
2. Press **Vehicle Settings**.
3. Press **Wipers**.
4. Switch **Rain Sensing** on or off.

**Note:** When you switch the feature off, the wipers do not operate based on the rain sensor. When you switch on the windshield wipers to the intermittent wipe position with the feature off, the wipers use the wipe speed set by the rotary control.

### AUTOWIPERS SETTINGS - VEHICLES WITH: 15 INCH SCREEN

1. Access the vehicle drawer on the touchscreen.
2. Press **SETTINGS**.
3. Press **Vehicle**.
4. Press **Wipers**.
5. Switch **Rain Sensing** on or off.

**Note:** When you switch the feature off, the wipers do not operate based on the rain sensor. When you switch on the windshield wipers to the intermittent wipe position with the feature off, the wipers use the wipe speed set by the rotary control.

# Wipers and Washers

## ADJUSTING THE SENSITIVITY OF THE RAIN SENSOR

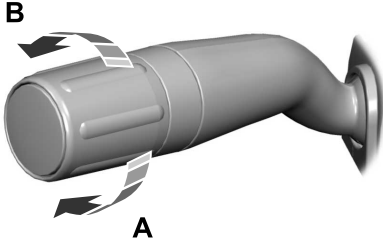

- A Low sensitivity.
- B High sensitivity.

Use the rotary control to set the sensitivity of the rain sensor.

When you select low sensitivity, the wipers operate when the sensor detects a large amount of water on the windshield.

When you select high sensitivity, the wipers operate when the sensor detects a small amount of water on the windshield.

## CHECKING THE WIPER BLADES



Run the tip of your fingers over the edge of the blade to check for roughness.

## REPLACING THE FRONT WIPER BLADES



1. Pull the wiper blade and arm away from the glass.

**Note:** Do not hold the wiper blade to lift the wiper arm.

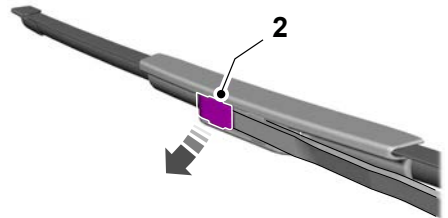

2. Lift the wiper blade primary locking clip.

# Wipers and Washers

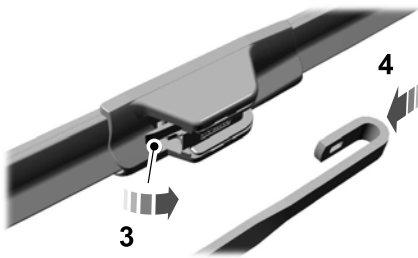

3. Press the wiper blade secondary locking clip.
4. Remove the wiper blade.

**Note:** Make sure that the wiper arm does not spring back against the glass when the wiper blade is not attached.

5. To install, reverse the removal procedure.

**Note:** Make sure that the wiper blade locks into place.

## WASHERS

### WASHER PRECAUTIONS



**WARNING:** If you operate your vehicle in temperatures below 41°F (5°C), use washer fluid with antifreeze protection. Failure to use washer fluid with antifreeze protection in cold weather could result in impaired windshield vision and increase the risk of injury or accident.

Do not operate the washers when the washer reservoir is empty. This could cause the washer pump to overheat.

Keep the outside of the windshield clean. The rain sensor is very sensitive and the wipers may operate if dirt, mist or insects hit the windshield.

### USING THE WINDSHIELD WASHER

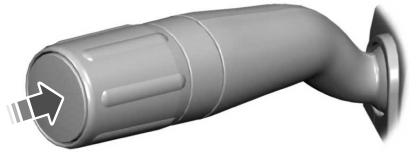

Press and hold the button at the end of the lever to operate the windshield washer.

**Note:** A courtesy wipe occurs a short time after the wipers stop to clear any remaining washer fluid when switched on. See **Switching the Courtesy Wipe On and Off** (page 112).

### SWITCHING THE COURTESY WIPE ON AND OFF - VEHICLES WITH: 12.3 INCH SCREEN

1. Press **Settings** on the touchscreen.
2. Press **Vehicle Settings**.
3. Press **Wipers**.
4. Switch **Courtesy Wipe** on or off.

### SWITCHING THE COURTESY WIPE ON AND OFF - VEHICLES WITH: 15 INCH SCREEN

1. Access the vehicle drawer on the touchscreen.
2. Press **SETTINGS**.

# Wipers and Washers

3. Press **Vehicle**.
4. Press **Wipers**.
5. Switch **Courtesy Wipe** on or off.

## ADDING WASHER FLUID

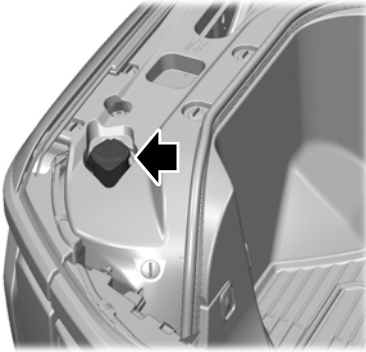

## WASHER FLUID SPECIFICATION

See **Washer Fluid Specification** (page 482).

## WIPERS AND WASHERS – TROUBLESHOOTING

### WIPERS AND WASHERS – WARNING LAMPS



Illuminates when the windshield washer fluid is low.

## WIPERS AND WASHERS – FREQUENTLY ASKED QUESTIONS

### Why are there streaks and smears on the windshield?

The wiper blades could be dirty, worn or damaged. Check the wiper blades. See **Checking the Wiper Blades** (page 111). If the wiper blades are dirty, clean them with washer fluid or water applied with a soft sponge or cloth. If the wiper blades are worn or damaged, install new ones. See **Replacing the Front Wiper Blades** (page 111).

# Exterior Lighting

## EXTERIOR LIGHTING CONTROL

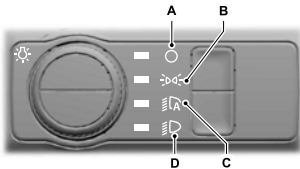

- A Lamps off.
- B Parking lamps on.
- C Autolamps on.
- D Headlamps on.

Rotate the control to make a selection.

**Note:** The lighting control defaults to autolamps every time you switch your vehicle on.

## HEADLAMPS

### USING THE HIGH BEAM HEADLAMPS

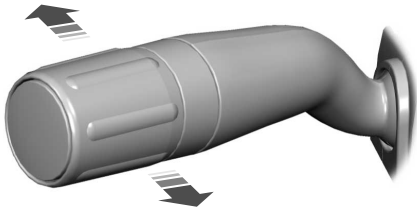

 Push the lever away from you to switch the high beam on.

Push the lever forward again or pull the lever toward you to switch the high beams off.

Slightly pull the lever toward you and release it to flash the headlamps.

## HEADLAMP INDICATORS

### Lamps On



Illuminates when you switch the low beam headlamps or the parking lamps on.

### Headlamp High Beam



Illuminates when you switch the high beam headlamps on.

## HEADLAMPS – TROUBLESHOOTING

### HEADLAMPS – FREQUENTLY ASKED QUESTIONS

#### Why is there condensation in the headlamps?

Headlamps have vents to accommodate normal changes in air pressure. Condensation can be a natural by-product of this design. When moist air enters the lamp assembly through the vents, there is a possibility that condensation can occur when the temperature is cold. When normal condensation occurs, a fine mist can form on the interior of the lens. The fine mist eventually clears and exits through the vents during normal operation.

#### How much condensation is acceptable?

The presence of a fine mist, for example no streaks, drip marks or large droplets. A fine mist covers less than 50% of the lens.

# Exterior Lighting

## How long may it take for the acceptable condensation to be cleared?

Clearing time may take as long as 48 hours under dry weather conditions.

## How much condensation is unacceptable?

A water puddle inside the lamp. Streaks, drip marks or large droplets present on the interior of the lens.

## What should I do if unacceptable condensation is present?

Have your vehicle checked as soon as possible.

## Why do my headlamps turn off when I have them switched on when I switch my vehicle off?

The battery saver turns the headlamps off after a short period of time after you switch your vehicle off.

## AUTOLAMPS

### WHAT ARE AUTOLAMPS



**WARNING:** The system does not relieve you of your responsibility to drive with due care and attention. You may need to override the system if it does not turn the headlamps on in low visibility conditions, for example daytime fog.

Autolamps turn the headlamps on in low light situations or when the windshield wipers operate.

### AUTOLAMP SETTINGS - VEHICLES WITH: 12.3 INCH SCREEN

1. Press **Settings** on the touchscreen.
2. Press **Vehicle Settings**.

3. Press **Lighting**.
4. Press **Autolamp Delay**.
5. Press a setting.

### AUTOLAMP SETTINGS - VEHICLES WITH: 15 INCH SCREEN

1. Access the vehicle drawer on the touchscreen.
2. Press **SETTINGS**.
3. Press **Vehicle**.
4. Press **Lighting**.
5. Press **Autolamp Delay**.
6. Press a setting.

## EXTERIOR LAMPS

### SWITCHING THE TURN SIGNAL LAMPS ON AND OFF

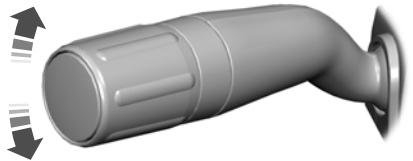

Push the lever up or down to switch the turn signal lamps on.

Set the lever to the middle position to switch the turn signal lamps off.

**Note:** Tap the lever up or down to make the turn signal lamps flash three times.

# Exterior Lighting

## SWITCHING THE DAYTIME RUNNING LAMPS ON AND OFF - VEHICLES WITH: CONFIGURABLE DAYTIME RUNNING LAMPS/15 INCH SCREEN



**WARNING:** The daytime running lamps system does not activate the rear lamps and may not provide adequate lighting during low visibility driving conditions. Make sure you switch the headlamps on, as appropriate, during all low visibility conditions. Failure to do so may result in a crash.

1. Access the vehicle drawer on the touchscreen.
2. Press **SETTINGS**.
3. Press **Vehicle**.
4. Press **Lighting**.
5. Switch **Daytime Running Lights** on or off.

The daytime running lamps turn on when all of the following occur:

- You switch the system on.
- You switch the vehicle on.
- The vehicle is not in park (P).
- The lighting control is in the autolamps position.
- The headlamps are off.

**Note:** *Other lighting control positions do not turn on the daytime running lamps.*

## SWITCHING THE DAYTIME RUNNING LAMPS ON AND OFF - VEHICLES WITH: CONFIGURABLE DAYTIME RUNNING LAMPS/12.3 INCH SCREEN



**WARNING:** The daytime running lamps system does not activate the rear lamps and may not provide adequate lighting during low visibility driving conditions. Make sure you switch the headlamps on, as appropriate, during all low visibility conditions. Failure to do so may result in a crash.

1. Press **Settings** on the touchscreen.
2. Press **Vehicle Settings**.
3. Press **Lighting**.
4. Switch **Daytime Running Lights** on or off.

The daytime running lamps turn on when all of the following occur:

- You switch the system on.
- You switch your vehicle on.
- The vehicle is not in park (P).
- The lighting control is in the autolamps position.
- The headlamps are off.

**Note:** *Other lighting control positions do not turn on the daytime running lamps.*



# Exterior Lighting

## SWITCHING THE DAYTIME RUNNING LAMPS ON AND OFF - VEHICLES WITH: DAYTIME RUNNING LAMPS (DRL)



**WARNING:** The daytime running lamps system does not activate the rear lamps and may not provide adequate lighting during low visibility driving conditions. Make sure you switch the headlamps on, as appropriate, during all low visibility conditions. Failure to do so may result in a crash.

Daytime running lamps are always on unless you switch on the headlamps or your vehicle is in park (P).

## SWITCHING THE CARGO LAMPS ON



Press the button in the lighting control or in the rear cargo box.

## SWITCHING THE SPOT LAMPS ON AND OFF

The spot lamp buttons are near the lighting control.



Press the button to switch on the left-hand spot lamp.



Press the button to switch on the right-hand spot lamp.

Move the position of the exterior mirrors to adjust the aim.

**Note:** Make sure you switch your vehicle on, with the vehicle in accessory mode or running.

**Note:** The spot lamps turn off after 6 mph (10 km/h).

**Note:** The spot lamps illuminate the area in front of and to the side of your vehicle.

## EXTERIOR LAMP INDICATORS

### Turn Signal Lamp



It flashes when you switch the turn signal lamps on.

**Note:** An increase in the rate of flashing warns of a failed turn signal lamp.

## EXTERIOR LAMP AUDIBLE WARNING

### Exterior Lamps On

Sounds when you open the driver door and the exterior lamps are on.

## EXTERIOR ZONE LIGHTING (IF EQUIPPED)

### WHAT IS EXTERIOR ZONE LIGHTING

Exterior zone lighting divides the exterior lighting into zones and allows you to switch them on and off to provide lighting around the perimeter of your vehicle.

### USING THE EXTERIOR ZONE LIGHTING - VEHICLES WITH: 12.3 INCH SCREEN

1. Press **Features** on the touchscreen.
2. Press **Zone Lighting**.

# Exterior Lighting

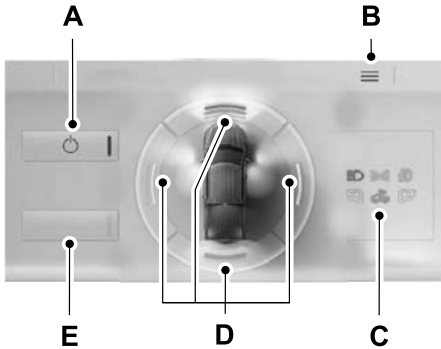

- A On and off button.
- B Settings menu.
- C Exterior lamp indicators.
- D Individual zones on and off.
- E All zones on and off.

You can use zone lighting when your vehicle is on or off. When it is off, the lighting turns off after a certain period of time.

You can also use individual zone controls to switch on each zone.

**Note:** Make sure to remove exterior lighting covers when using zone lighting.

**Note:** When your vehicle is off and the timer has one minute remaining, the direction indicators flash six times.

**Note:** Indicators on the touchscreen illuminate when the lights outside of the zone lighting control are on.

**Note:** You can remotely control the zone lighting using the FordPass app.

**Note:** Vehicles without spot lamps only have two zones.

## USING THE EXTERIOR ZONE LIGHTING - VEHICLES WITH: 15 INCH SCREEN

1. Access the vehicle drawer on the touchscreen.
2. Press **CONTROLS**.
3. Press **Zone Lighting**.

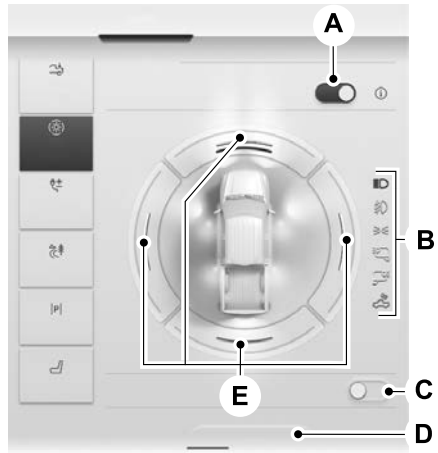

- A On and off button.
- B Exterior lamp indicators.
- C All zones on and off.
- D Settings menu.
- E Individual zones on and off.

You can use zone lighting when your vehicle is on or off. When it is off, the lighting turns off after a certain period of time.

You can also use individual zone controls to switch on each zone.

**Note:** Make sure to remove exterior lighting covers when using zone lighting.

# Exterior Lighting

**Note:** When your vehicle is off and the timer has one minute remaining, the direction indicators flash six times.

**Note:** Indicators on the touchscreen illuminate when the lights outside of the zone lighting control are on.

**Note:** You can remotely control the zone lighting using the FordPass app.

**Note:** Vehicles without spot lamps only have two zones.

## EXTERIOR ZONE LIGHTING SETTINGS - VEHICLES WITH: 12.3 INCH SCREEN

1. Press **Features** on the touchscreen.
2. Press **Zone Lighting**.
3. Press the settings menu in the upper right-hand corner.
4. Press a setting.

### Enable Autolamp Override

This setting allows your vehicle to override the autolamps when using zone lighting.

When you access zone lighting for the first time, you can choose this setting. You can change this setting at any time.

### Include Reverse Lamps

This setting turns the reverse lamps on when you switch the rear lighting zone on.

Switch this setting off if you have a backup alarm installed to prevent the reverse lamps from turning on and sounding the alarm when using zone lighting.

## EXTERIOR ZONE LIGHTING SETTINGS - VEHICLES WITH: 15 INCH SCREEN

1. Access the vehicle drawer on the touchscreen.

2. Press **CONTROLS**.
3. Press **Zone Lighting**.
4. Press **Settings**.
5. Press a setting.

### Enable Autolamp Override

This settings allows the vehicle to override the autolamps when zone lighting is on.

When you access zone lighting for the first time, you can choose this setting. You can change this setting at any time.

### Include Reverse Lamps

This setting turns the reverse lamps on when you switch the rear lighting zone on.

Switch this setting off if you have a backup alarm installed to prevent the reverse lamps from turning on and sounding the alarm when using zone lighting.

## AUTOMATIC HIGH BEAM CONTROL

### HOW DOES AUTOMATIC HIGH BEAM CONTROL WORK

Automatic high beam control turns the high beams on if it is dark enough and no other traffic is present. If it detects an approaching vehicle's headlamps or tail lamps, or street lighting ahead, the system turns the high beams off.

A camera sensor, centrally mounted behind the windshield of your vehicle, continuously monitors conditions to turn the high beams on and off.

# Exterior Lighting

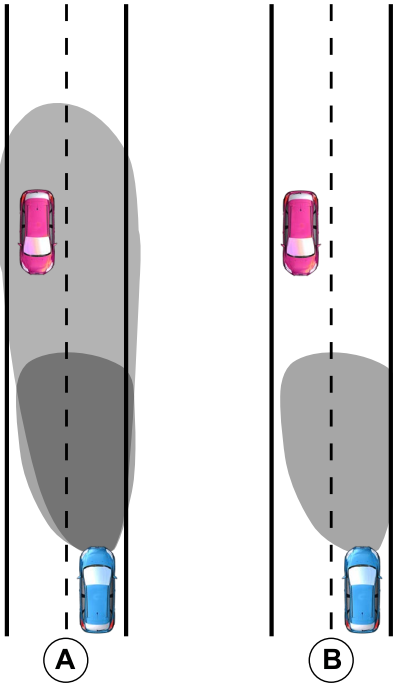

- A Without automatic high beam control.
- B With automatic high beam control.

## AUTOMATIC HIGH BEAM CONTROL PRECAUTIONS

**WARNING:** The system does not relieve you of your responsibility to drive with due care and attention. You may need to override the system if it does not turn the high beams on or off.

**WARNING:** The system may not switch the high beams off if the lights of oncoming vehicles are hidden by obstacles, for example guard rails.

**WARNING:** Do not use the system in poor visibility, for example fog, heavy rain, spray or snow.

**WARNING:** You may need to override the system when approaching other road users.

**WARNING:** You may need to override the system during inclement weather.

## AUTOMATIC HIGH BEAM CONTROL REQUIREMENTS

The system turns the high beams on if all of the following occur:

- You switch the system on.
- You set the lighting control to the autolamps position.
- The ambient light level is low enough that you require high beams.
- There is no traffic in front of your vehicle.
- The vehicle speed is greater than approximately 32 mph (52 km/h).

## AUTOMATIC HIGH BEAM CONTROL LIMITATIONS

The system turns the high beams off if any of the following occur:

- You switch the system off.
- You set the lighting control to any position except autolamps.
- The ambient light level is high enough that you do not require high beams.

## Exterior Lighting

- The system detects an approaching vehicle's headlamps or a leading vehicle's tail lamps.
- The system detects severe rain, snow or fog.
- The system detects street lighting.
- The camera has reduced visibility.
- The vehicle speed falls below approximately 19 mph (30 km/h).

### SWITCHING AUTOMATIC HIGH BEAM CONTROL ON AND OFF - VEHICLES WITH: 12.3 INCH SCREEN

1. Press **Settings** on the touchscreen.
2. Press **Vehicle Settings**.
3. Press **Lighting**.
4. Switch **Auto Highbeam** on or off.

### SWITCHING AUTOMATIC HIGH BEAM CONTROL ON AND OFF - VEHICLES WITH: 15 INCH SCREEN

1. Access the vehicle drawer on the touchscreen.
2. Press **SETTINGS**.
3. Press **Vehicle**.
4. Press **Lighting**.

5. Switch **Auto Highbeam** on or off.

### AUTOMATIC HIGH BEAM CONTROL INDICATORS



Illuminates to confirm when the system is ready to assist.

### OVERRIDING AUTOMATIC HIGH BEAM CONTROL

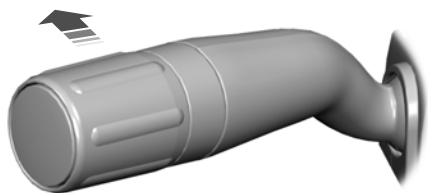

Push the lever away from you to switch the high beams on.

Push the lever away from you again to switch the high beams off.

Push the lever away from you for a third time to switch automatic high beam control back on.

# Exterior Lighting

---

## **AUTOMATIC HIGH BEAM CONTROL – TROUBLESHOOTING**

### **AUTOMATIC HIGH BEAM CONTROL – INFORMATION MESSAGES**

<b>Message</b>	<b>Description</b>
Front Camera Low Visibility Clean Screen	The camera has reduced visibility. Clean the windshield. If the message continues to appear, have your vehicle checked as soon as possible.
Front Camera Temporarily Not Available	The camera has malfunctioned. Wait a short period of time for the camera to cool down. If the message continues to appear, have your vehicle checked as soon as possible.
Front Camera Malfunction Service Required	The camera has malfunctioned. Have your vehicle checked as soon as possible.

## **GLARE FREE LIGHTING**

### **HOW DOES GLARE FREE LIGHTING WORK**

Glare free lighting enhances visibility and minimizes glare for other road users.

# Exterior Lighting

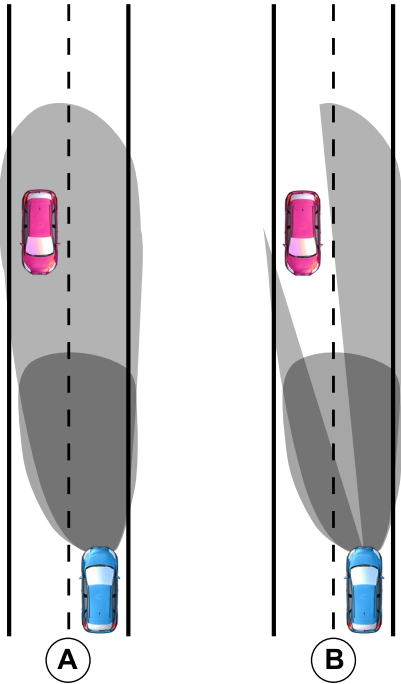

- A Without glare free lighting.  
B With glare free lighting.

## GLARE FREE LIGHTING PRECAUTIONS

**WARNING:** The system does not relieve you of your responsibility to drive with due care and attention. You may need to override the system if it does not adapt the light.

- WARNING:** The system may not adapt the lighting to avoid glare if the lights of oncoming vehicles are hidden by obstacles such as guard rails.
- WARNING:** You may need to override the system when approaching other road users.
- WARNING:** You may need to override the system during inclement weather.
- WARNING:** Do not use the system in poor visibility, for example fog, heavy rain, spray or snow.

## GLARE FREE LIGHTING REQUIREMENTS

The system turns on if all of the following occur:

- You switch the system on.
- You set the lighting control to the autolamps position.
- The ambient light level is low enough.
- Your vehicle speed is greater than approximately 32 mph (52 km/h).

The system adapts the lighting to avoid glare if all of the following occur:

- You switch the system on.
- You set the lighting control to the autolamps position.
- The system detects an approaching vehicle's headlamps or rear lamps.

# Exterior Lighting

## GLARE FREE LIGHTING LIMITATIONS

The system turns off if any of the following occur:

- You switch the system off.
- You set the lighting control to any position except autolamps.
- The ambient light level is high enough.
- The system detects severe rain, snow or fog.
- The system detects street lighting.
- The camera has reduced visibility.
- The vehicle speed falls below approximately 19 mph (30 km/h).

**Note:** *The deactivation speed is lower on curves.*

## SWITCHING GLARE FREE LIGHTING ON AND OFF - VEHICLES WITH: 12.3 INCH SCREEN

1. Press **Settings** on the touchscreen.
2. Press **Vehicle Settings**.
3. Press **Lighting**.
4. Switch **Glarefree Lighting** on or off.

## SWITCHING GLARE FREE LIGHTING ON AND OFF - VEHICLES WITH: 15 INCH SCREEN

1. Access the vehicle drawer on the touchscreen.

2. Press **SETTINGS**.
3. Press **Vehicle**.
4. Press **Lighting**.
5. Switch **Glarefree Lighting** on or off.

## GLARE FREE LIGHTING INDICATORS



Illuminates to confirm when the system is ready to assist.

## OVERRIDING GLARE FREE LIGHTING

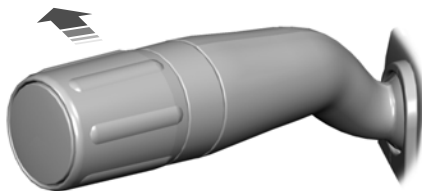

Push the lever away from you to switch the high beams on.

Push the lever away from you again to switch the high beams off.

Push the lever away from you for a third time to switch glare free lighting back on.



# Exterior Lighting

## GLARE FREE LIGHTING – TROUBLESHOOTING

### GLARE FREE LIGHTING – INFORMATION MESSAGES

Message	Description
Front Camera Low Visibility Clean Screen	The camera has reduced visibility. Clean the windshield. If the message continues to appear, have your vehicle checked as soon as possible.
Front Camera Temporarily Not Available	The camera has malfunctioned. Wait a short period of time for the camera to cool down. If the message continues to appear, have your vehicle checked as soon as possible.
Front Camera Malfunction Service Required	The camera has malfunctioned. Have your vehicle checked as soon as possible.

## ADAPTIVE FRONT LIGHTING

### HOW DOES ADAPTIVE FRONT LIGHTING WORK

Adaptive front lighting adapts when you are steering around a curve or if the camera detects lane markings indicating a curve.

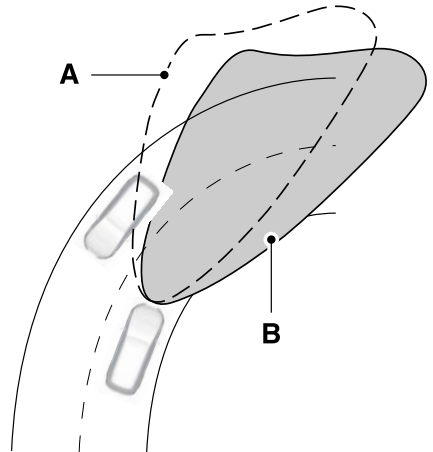

- A Without adaptive front lighting.
- B With adaptive front lighting.

# Exterior Lighting

---

## **SWITCHING ADAPTIVE FRONT LIGHTING ON AND OFF**

Set the lighting control to the autolamps position to use adaptive front lighting.

**Note:** *Other lighting control positions do not turn on adaptive front lighting.*

# Interior Lighting

## SWITCHING ALL OF THE INTERIOR LAMPS ON AND OFF

The lamps turn on under the following conditions:

- You open any door.
- You press a button on the remote control.
- You press the all lamps on button on the overhead console.



Press to switch all interior lamps on or off.

## SWITCHING THE FRONT INTERIOR LAMPS ON AND OFF



The front interior lamp switches are on the overhead console.

**Note:** The position of each button on the overhead console depends on your vehicle.

### Individual Map Lamps



Press to switch the left-hand individual dome lamp on and off.



Press to switch the right-hand individual dome lamp on and off.

## SWITCHING THE REAR INTERIOR LAMPS ON AND OFF



The rear interior lamps may be above the rear seat or above the rear windows.



Press to switch the lamps on or off.

**Note:** If you switch the rear lamps on through the overhead console, you cannot switch them off with the rear lamp switch.

## INTERIOR LAMP FUNCTION

### WHAT IS THE INTERIOR LAMP FUNCTION

The interior lamp function switches the courtesy and door lamps on or off.

### SWITCHING THE INTERIOR LAMP FUNCTION ON AND OFF



Press to switch the interior lamp function on and off.

**Note:** The indicator lamp illuminates amber when the door function is off.

# Interior Lighting

## ADJUSTING THE INSTRUMENT PANEL LIGHTING BRIGHTNESS

The instrument lighting dimmer buttons are on the lighting control.



Repeatedly press one of the buttons to adjust the brightness.



## AMBIENT LIGHTING (IF EQUIPPED)

### SWITCHING AMBIENT LIGHTING ON AND OFF

1. Press **Settings** on the touchscreen.
2. Press **Vehicle Settings**.
3. Press **Ambient Light**.
4. Switch **Ambient Light** on or off.

### ADJUSTING AMBIENT LIGHTING

Drag the slider left or right.

## CARGO LAMPS

### SWITCHING THE CARGO LAMPS ON AND OFF

There are two overhead lamps in the frunk. The lamps turn on when you open the frunk.

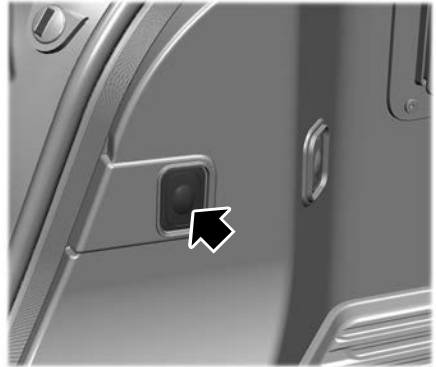

Press the button to switch the frunk lamps on or off.

The frunk lamps turn off after a short period of time to prevent the battery from running out of charge.

## INTERIOR LIGHTING – TROUBLESHOOTING

### INTERIOR LIGHTING – FREQUENTLY ASKED QUESTIONS

**Why do my courtesy lamps or interior lamps turn off when I have them switched on when I switch my vehicle off?**

The battery saver turns the courtesy lamps and interior lamps off after a short period of time after you switch your vehicle off.

# Windows

## OPENING AND CLOSING THE WINDOWS



**WARNING:** Do not leave children unattended in your vehicle and do not let them play with the power windows. Failure to follow this instruction could result in personal injury.



**WARNING:** When closing the power windows, verify they are free of obstruction and make sure that children and pets are not in the proximity of the window openings.



Press the window control switch to open the window. Lift the window control switch to close the window.

**Note:** The power windows operate with the ignition on, and for several minutes after you switch the ignition off or until you open a front door.

To reduce wind noise or pulsing noise when one window is open, slightly open the opposite window.

### One-Touch Open

Fully press the window control switch and release it. Press again or lift it to stop the window.

### One-Touch Close

Fully lift the window control switch and release it. Press again or lift it to stop the window.

### Resetting One-Touch Close

Carry out all steps within 30 seconds of starting the sequence.

1. Close the window.

2. Press and hold the window control switch until the window is fully open. Keep the window control switch pressed for a few seconds.
3. Lift and hold the window control switch until the window is fully closed. Keep the window control switch held for a few seconds.
4. Press and hold the window control switch until the window is fully open. Keep the window control switch pressed for a few seconds.
5. Lift and hold the window control switch until the window is fully closed. Keep the window control switch held for a few seconds.

**Note:** Repeat the procedure if the window does not close when you use one-touch.

## WINDOW BOUNCE-BACK

### WHAT IS WINDOW BOUNCE-BACK

The window stops and reverses if it detects an obstruction when closing.

### OVERRIDING WINDOW BOUNCE-BACK



**WARNING:** If you override bounce-back, the window does not reverse if it detects an obstacle. Take care when closing the windows to avoid personal injury or damage to your vehicle.

1. Close the window until it reaches the point of resistance and let it reverse.
2. Lift and hold the window control switch within two seconds to override bounce-back and close the window. Bounce-back is now disabled and you can close the window manually.

# Windows

**Note:** The window goes past the point of resistance and you can fully close it.

**Note:** If the window does not close, have your vehicle checked as soon as possible.

Press and hold the window control switch to open the window. Pull and hold the window control switch to close the window.

## LOCKING THE REAR WINDOW CONTROLS (IF EQUIPPED)



Press the window control switch to lock or unlock the rear window controls. It illuminates when you lock the rear window controls.

## OPENING AND CLOSING THE SLIDING WINDOWS (IF EQUIPPED)



**WARNING:** When closing the power windows, verify they are free of obstruction and make sure that children and pets are not in the proximity of the window openings.



**WARNING:** Do not leave children unattended in your vehicle and do not let them play with the power windows. Failure to follow this instruction could result in personal injury.

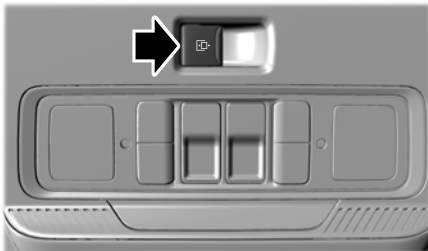

The window control switch is on the overhead console.

# Interior Mirror

---

## INTERIOR MIRROR PRECAUTIONS



**WARNING:** Do not adjust the mirrors when your vehicle is moving. This could result in the loss of control of your vehicle, serious personal injury or death.

**Note:** Do not clean the mirror housing or glass with harsh abrasives, fuel or other petroleum-based cleaning products.

## MANUALLY DIMMING THE INTERIOR MIRROR

Pull the tab below the mirror toward you to reduce glare at night.

## AUTO-DIMMING INTERIOR MIRROR (IF EQUIPPED)

### WHAT IS THE AUTO-DIMMING INTERIOR MIRROR

The mirror dims to reduce the effect of bright light from behind. It returns to normal when the bright light from behind is no longer present or if you shift into reverse (R).

### AUTO-DIMMING INTERIOR MIRROR LIMITATIONS

Do not block the sensors on the front and back of the mirror.

**Note:** A rear center passenger or raised rear center head restraint could prevent light from reaching the sensor.

# Exterior Mirrors

## ADJUSTING THE EXTERIOR MIRRORS



**WARNING:** Do not adjust the mirrors when your vehicle is moving. This could result in the loss of control of your vehicle, serious personal injury or death.

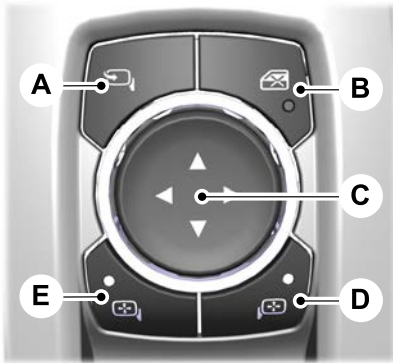

- A Power fold.
- B Window lock.
- C Adjustment control.
- D Right-hand mirror.
- E Left-hand mirror.

To adjust the mirrors, switch your vehicle on and place the ignition in accessory or start.

1. Select the mirror you want to adjust. The control light turns on.
2. Use the adjustment control to adjust the position of the mirror.
3. Press the mirror control again. The control light turns off.

## FOLDING THE EXTERIOR MIRRORS - VEHICLES WITH: MANUAL FOLDING MIRRORS

Push the mirror toward the door window glass.

Make sure that you fully engage the mirror in its support when returning it to its original position.

## FOLDING THE EXTERIOR MIRRORS - VEHICLES WITH: POWER FOLDING MIRRORS

The exterior mirrors fold when you lock your vehicle and unfold when you unlock your vehicle.



For tight parking conditions, press the control to fold the mirrors.

Press the control switch again to unfold the mirrors.

**Note:** Do not stop the mirrors midway through their movement. Wait until the mirrors stop moving and press the control again.

The left-hand and right-hand mirrors move at different rates. For example, one mirror may stop while the other one continues to move. This is normal.

If you press the control switch to fold the mirrors with auto fold on, the mirrors do not unfold when you unlock your vehicle.

**Note:** The power folding mirrors operate with the ignition on, and for several minutes after you switch the ignition off.

**Note:** If you fold and unfold the mirrors several times within one minute, the power fold function may turn off to protect the motors from overheating.



# Exterior Mirrors

---

## Switching Auto fold On and Off

1. Press **Settings** on the touchscreen.
2. Press **Vehicle Settings**.
3. Press **Mirrors**.
4. Switch **Autofold** on or off.

## Loose Mirror

If your power folding mirrors are manually folded, they may not work properly even after you reposition them. You need to reset them if:

- The mirrors vibrate when you drive.
- The mirrors feel loose.
- The mirrors do not stay in the folded or unfolded position.
- One of the mirrors is not in its normal driving position.

To reset the mirrors perform the following steps:

1. Fold or retract both mirrors manually.
2. Using the power folding/power telescoping mirror control switch, operate the mirrors until you hear an audible click.
3. Operate the power folding or power telescoping mirrors an additional 3 to 4 times to synchronize the mirrors.

## AUTO-DIMMING EXTERIOR MIRROR (IF EQUIPPED)

### WHAT IS THE AUTO-DIMMING EXTERIOR MIRROR

The driver exterior mirror dims when the interior auto-dimming mirror turns on.

## Moonroof (If Equipped)

### OPENING AND CLOSING THE SUNSHADE



**WARNING:** Do not leave children unattended in your vehicle and do not let them play with the sun shades. Failure to follow this instruction could result in personal injury.

The controls are on the overhead console.

#### Opening the Sun Shade



Press and release the switch to activate the one-touch open feature. To stop movement, press the switch a second time. The sun shade also opens when you open the moonroof.

**Note:** *The sun shade stops short of its fully opened position for the comfort of rear passengers. To fully open the sun shade, press the switch again.*

#### Closing the Sun Shade



Press and release the switch to activate the one-touch close feature. To stop movement, press the switch a second time.

**Note:** *If fully open, the sun shade stops after covering the rear glass panel. Press and release again to fully close the sun shade.*

**Note:** *If the moonroof is either in the open or vent position and the sun shade is in the mid-open position, press and release the switch to close the moonroof first and then the sun shade.*

### OPENING AND CLOSING THE MOONROOF



**WARNING:** Do not leave children unattended in your vehicle and do not let them play with the moonroof. Failure to follow this instruction could result in personal injury.



**WARNING:** When closing the moonroof, verify that it is free of obstruction and make sure that children and pets are not in the proximity of the roof opening.

The controls are on the overhead console.

#### Opening the Moonroof



Press and release the switch to activate the one-touch open feature. To stop movement, press the switch a second time.

**Note:** *The moonroof stops short of the fully opened position to reduce wind noise or rumbling that may happen with the moonroof fully open.*

*Press and release the switch again to fully open the moonroof.*

#### Closing the Moonroof



Press and release the switch to activate the one-touch close feature, from either the open or vent positions. To stop movement, press the switch a second time.

## VENTING THE MOONROOF



**WARNING:** Do not leave children unattended in your vehicle and do not let them play with the moonroof. Failure to follow this instruction could result in personal injury.

The moonroof controls are on the overhead console.



With the moonroof in the closed position, press and release the switch to vent the moonroof. To close the moonroof from the vent position, press and release the switch again.

## MOONROOF BOUNCE-BACK

### WHAT IS MOONROOF BOUNCE-BACK

The moonroof stops and reverses some distance if it detects an obstacle when closing.

### OVERRIDING MOONROOF BOUNCE-BACK

Press and hold the close switch within two seconds after the moonroof comes to a stop.

# Instrument Cluster

## INSTRUMENT CLUSTER OVERVIEW

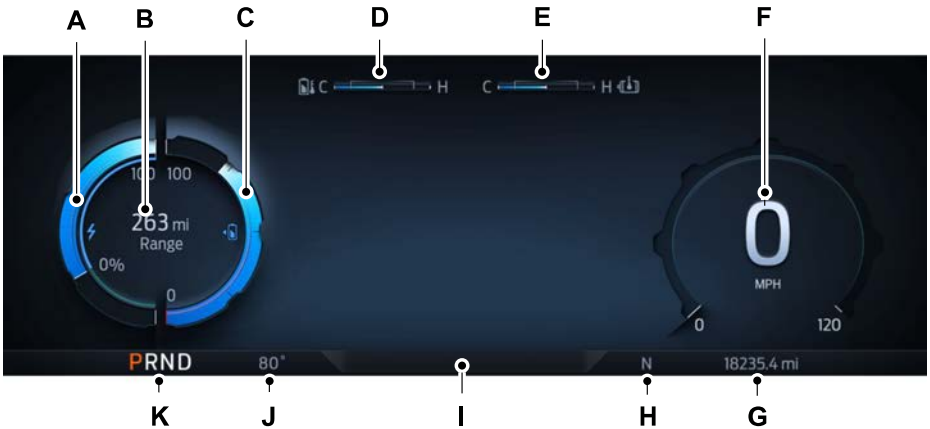

- A Power gauge.
- B Vehicle range display.
- C High voltage battery gauge.
- D High voltage battery temperature gauge.
- E Electric motor temperature gauge.
- F Speedometer.
- G Odometer.
- H Compass.
- I Information bar.
- J Ambient temperature.
- K Gearshift indicator.

# Instrument Cluster

---

## POWER GAUGE

The power gauge displays the amount of power going to the wheels when accelerating or maintaining speed. The inner thin blue line represents the percentage of maximum power available. When the system limits the available maximum power the blue line moves down and the available power is shown as less than 100%. A corresponding message could display when available power is reduced.

When slowing down by lifting your foot off the accelerator pedal or pressing the brake, the power gauge displays the amount of power the regenerative braking system captures and returns to the high voltage battery.

## SPEEDOMETER

Indicates the vehicle speed.

## VEHICLE RANGE DISPLAY

Displays the approximate range your vehicle can travel on the battery's current state of charge. Estimates vary based on the energy used when driving and the energy available in the high voltage battery.

The amount of energy being used when driving is affected by:

- Mild or aggressive acceleration or braking.
- Your vehicle's speed.
- Use of accessories, such as climate control.
- Ambient temperature and weather conditions.
- Driving in a city or on a highway.
- Driving on flat or hilly roads.
- Towing.

The available energy capacity in the high voltage battery is affected by cold temperatures and battery degradation. See **Preserving Your High Voltage Battery** (page 197).

When your navigation system has an active route the distance to your destination or next charging station is displayed.

**Note:** *It is normal for the vehicle range estimates to vary due to changes in average energy usage and battery temperature. This could cause different range estimates each time you fully charge your battery. See **Maximizing Your Driving Range** (page 416).*

**Note:** *When you leave your vehicle unplugged, it periodically uses energy from the high voltage battery to recharge the 12-volt accessory battery, resulting in a reduced driving range.*

## HIGH VOLTAGE BATTERY GAUGE

Displays the high voltage battery state of charge. A full, or 100%, charge represents the total amount of energy you can get from plugging your vehicle in.

When a low battery condition is reached the gauge is amber. When the battery is depleted the gauge is red.

When your navigation system has an active route, a symbol is added to indicate the battery charge level needed to reach your destination or the next charging station.

# Instrument Cluster

## Charging Status

When you open the door an expanded high voltage battery gauge displays. When plugged in, additional charging information displays such as the charging start or end time and the state of charge limit at which charging stops. You can modify your vehicle charge settings on the center display screen. See **Setting the Charging Schedule and Preferences** (page 214).

When your navigation system has an active route, the charge level required to reach your destination or next charging station displays. When plugged in, the time when that charge level will be available also displays.

## HIGH VOLTAGE BATTERY TEMPERATURE GAUGE

Displays the high voltage battery temperature.

When the battery temperature is outside the normal range, vehicle performance could be reduced and a corresponding message could display.

- When the temperature is too cold, continue driving to warm the system and improve performance.
- When the temperature is too hot, performance could be reduced to cool the system.

## ELECTRIC MOTOR TEMPERATURE GAUGE

Displays electric motor temperature.

When the battery temperature is outside the normal range, vehicle performance could be reduced and a corresponding message could display.

- When the temperature is too cold, continue driving to warm the system and improve performance.
- When the temperature is too hot, performance could be reduced to cool the system.

## WHAT ARE THE INSTRUMENT CLUSTER WARNING LAMPS

Warning lamps alert you to a vehicle condition that could become serious. Some lamps illuminate when you start your vehicle to make sure they work. If any lamps remain on after starting your vehicle, refer to the respective system warning lamp for further information.

## INSTRUMENT CLUSTER WARNING LAMPS

### 12V Battery



Illuminates when your vehicle is first switched on to show it is properly functioning.

If it illuminates when the motor is running, this indicates your vehicle requires service. Have your vehicle checked as soon as possible.

Driving when this warning lamp is on drains the 12V battery. If you must drive with this light on, turn off all accessories.

### Anti-Lock Brake System



If it illuminates when you are driving, this indicates the system requires service. Your vehicle continues to have normal braking without the anti-lock brake system function. Have your vehicle checked as soon as possible.

# Instrument Cluster

## Brake System



Illuminates when you apply the parking brake and your vehicle is on. If it illuminates when your vehicle is moving, make sure the parking brake is released. If the parking brake is released, this indicates low brake fluid level or the brake system requires service. Have your vehicle checked as soon as possible.



**Note:** Lamps may vary depending on region.

## Door Ajar



Illuminates when your vehicle is on and remains on if any door is open.

## Electric Motor Temperature



Illuminates when the electric motor temperature is either cold or hot.

- When the temperature is too cold, continue driving to warm the system and improve performance.
- When the temperature is too hot, performance could be reduced to cool the system.

## Electric Park Brake



Illuminates or flashes yellow when the electric parking brake requires service.



## Fasten Seatbelt



Illuminates and a chime sounds until you fasten the seatbelts.

## High Voltage Battery



Illuminates blue under normal conditions. If it illuminates amber, the battery is low on charge. If it illuminates red, the battery is depleted.

## High Voltage Battery Temperature



Illuminates when the high voltage battery temperature is either cold or hot.

- When the temperature is too cold, continue driving to warm the system and improve performance.
- When the temperature is too hot, performance could be reduced to cool the system.

## Hood Ajar



Illuminates when the ignition is on and the hood is not completely closed.

## Low Tire Pressure



Illuminates when your tire pressure is low. If illuminated, check your tire pressure as soon as possible. If it begins to flash at any time, have the system checked as soon as possible.

## Low Washer Fluid Level



Illuminates when the washer fluid is low.

# Instrument Cluster

## Powertrain Malfunction, Reduced Power, Electronic Throttle Control, Check 4X4



Illuminates when the powertrain or four-wheel drive require service. Have the system checked as soon as possible.

## Powertrain Temperature



If it illuminates, safely stop your vehicle and switch your vehicle off.

## Stop Safely



Illuminates if an electrical component requires service or a failure that causes your vehicle to shutdown or enter into a limited operating mode.

## Tailgate Ajar



Illuminates when the ignition is on and the tailgate is not completely closed.

## Vehicle Plugged In



Illuminates when your vehicle is plugged in.

## WHAT ARE THE INSTRUMENT CLUSTER INDICATORS

Indicators notify you of various features that are active on your vehicle.

## INSTRUMENT CLUSTER INDICATORS

### Adaptive Cruise Control



See **Adaptive Cruise Control** (page 273).

### Automatic Headlamp High Beam



See **Automatic High Beam Control Indicators** (page 121).

### Auto Hold Active



See **Auto Hold** (page 247).

### Auto Hold Unavailable



See **Auto Hold** (page 247).

### Blind Spot Information System



See **Blind Spot Information System** (page 304).

### Cruise Control



See **Cruise Control** (page 271).

### Electronic Locking Differential



See **Electronic Locking Differential** (page 233).

### Front Airbag



See **Airbags** (page 55).



# Instrument Cluster

---

## Headlamp High Beam



See **Headlamp Indicators** (page 114).

## Parking Lamps



See **Headlamp Indicators** (page 114).

## Ready to Drive



See **Starting and Powering Off** (page 194).

## Stability Control and Traction Control



See **Stability Control** (page 251). See **Traction Control** (page 249).



## Tow Haul



See **Towing a Trailer** (page 352).

## Turn Signal Lamps



See **Switching the Turn Signal Lamps On and Off** (page 115).

# Instrument Cluster Display

## USING THE INSTRUMENT CLUSTER DISPLAY CONTROLS



**WARNING:** Driving while distracted can result in loss of vehicle control, crash and injury. We strongly recommend that you use extreme caution when using any device that may take your focus off the road. Your primary responsibility is the safe operation of your vehicle. We recommend against the use of any hand-held device while driving and encourage the use of voice-operated systems when possible. Make sure you are aware of all applicable local laws that may affect the use of electronic devices while driving.

The controls are on the steering wheel.

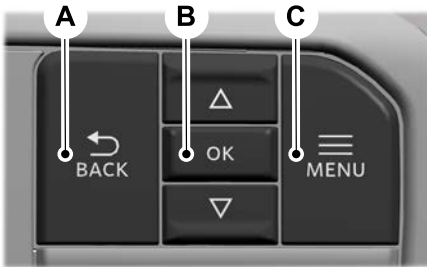

- A Back button.
- B OK button.
- C Menu button.

### Back Button

Press to go back or to exit a menu.

### OK Button

Press to make a selection.

### Menu Button

Press to display the submenus.

### Scroll Buttons

Press the up or down buttons to scroll through the menu items.

### Status Indicator



Menu items with a check box indicates a feature's status. A check in the box indicates the feature is on, and unchecked indicates the feature is off.

## INSTRUMENT CLUSTER DISPLAY MAIN MENU

Depending on your vehicle options, some menu items can appear different or not at all.

**Note:** For your safety, some features are speed-dependent and could be unavailable when your vehicle is above a certain speed.

Menu Item
MyView
Trip
Truck Info
Towing
Navigation
Phone
Audio
Settings

# Instrument Cluster Display

---

## CUSTOMIZING THE INSTRUMENT CLUSTER DISPLAY

### Adding Screens Using MyView

1. Using the instrument cluster display controls on the steering wheel, select **MyView**.
2. Select **Configure MyView**.
3. Select a screen.
4. Press the **OK** button.

**Note:** *The number of screens you can add is limited. If the selected screen does not appear you must deselect screens from the MyView menu.*

## BRAKE COACH

The brake coach appears after the vehicle has come to a stop. It coaches you to brake in a manner that maximizes the amount of energy returned through the regenerative braking system.

The percent displayed is an indication of the regenerative braking efficiency with 100% representing the maximum amount of energy recovery. You can switch brake coach on or off in the settings menu on your touchscreen.

## TRIP SUMMARY

Displays the trip summary when you switch off your vehicle. The values are cumulative since you last started your vehicle.

## VEHICLE CHARGING STATUS

The vehicle charge status displays when you switch off your vehicle. Charging status includes the charge start or charge end time and the state of charge limit at which charging will stop. You can modify your charge settings through the touchscreen. See **Setting the Charging Schedule and Preferences** (page 214).

## Personalized Settings - Vehicles With: 12.3 Inch Screen

---

### CHANGING THE LANGUAGE

1. Press **Settings** on the touchscreen.
2. Press **General**.
3. Press **Language**.
4. Select a language.

### CHANGING THE MEASUREMENT UNIT

1. Press **Settings** on the touchscreen.
2. Press **General**.
3. Press **Measurement Units**.
4. Select a measurement unit.

### CHANGING THE TEMPERATURE UNIT

1. Press **Settings** on the touchscreen.
2. Press **General**.
3. Press **Temperature Units**.
4. Select a temperature unit.

### CHANGING THE TIRE PRESSURE UNIT

1. Press **Settings** on the touchscreen.
2. Press **General**.
3. Press **Tire Pressure Units**.
4. Select a pressure unit.

# Personalized Settings - Vehicles With: 15 Inch Screen

---

## CHANGING THE LANGUAGE

1. Access the vehicle drawer on the touchscreen.
2. Press **SETTINGS**.
3. Press **General**.
4. Press **Language**.
5. Select a language.

## CHANGING THE MEASUREMENT UNIT

1. Access the vehicle drawer on the touchscreen.
2. Press **SETTINGS**.
3. Press **General**.
4. Press **Measurement Units**.
5. Select a measurement unit.

## CHANGING THE TEMPERATURE UNIT

1. Access the vehicle drawer on the touchscreen.
2. Press **SETTINGS**.
3. Press **General**.
4. Press **Temperature Units**.
5. Select a temperature unit.

## CHANGING THE TIRE PRESSURE UNIT

1. Access the vehicle drawer on the touchscreen.
2. Press **SETTINGS**.
3. Press **General**.
4. Press **Tire Pressure Units**.
5. Select a pressure unit.

# Trip Computer

---

## ACCESSING THE TRIP COMPUTER

1. Using the instrument cluster display controls on the steering wheel, select **Trip**.
2. Select the option you prefer.

## RESETTING THE TRIP COMPUTER

1. Using the instrument cluster display controls on the steering wheel, select **Trip**.
2. Select **Trip 1** or **Trip 2**.
3. Press and hold the **OK** button for a few seconds.

**Note:** *This Trip resets every time you start your vehicle.*

## TRIP DATA - VEHICLES WITH: 12.3 INCH SCREEN

Trip data includes distance, time and electric economy. Better electric economy, meaning greater efficiency or lower consumption, results in increased driving range.

### Trip Energy

Trip energy displays a breakdown of energy consumption for your trips.

1. Press **Features** on the touchscreen.
2. Press **Trip Energy**.

### Climate Use

This includes energy used by your vehicle's high voltage climate control components such as the electric A/C compressor and the electric heater.

### Driving and Route

This includes energy used to propel your vehicle based on your driving style and route. Your driving style includes how fast you drive and whether your acceleration and braking is mild or aggressive. Your route includes factors such as the amount of city or highway driving and road grades. Additional energy used due to heavy loads or trailer towing is also included here.

### Accessories

This includes energy used for low voltage accessories such as climate system fans, heated seats and lighting. Pro Power Onboard usage is also included.

### Exterior Temperature

This includes energy losses due to outside temperature and other conditions which reduce vehicle system efficiency.

## TRIP DATA - VEHICLES WITH: 15 INCH SCREEN

Trip data includes distance, time and electric economy. Better electric economy, meaning greater efficiency or lower consumption, results in increased driving range.

### Trip Energy

Trip energy displays a breakdown of energy consumption for your trips.

1. Access the app drawer on the touchscreen.
2. Press **Trip Energy**.

### Climate Use

This includes energy used by your vehicle's high voltage climate control components such as the electric A/C compressor and the electric heater.

# Trip Computer

---

## **Driving and Route**

This includes energy used to propel your vehicle based on your driving style and route. Your driving style includes how fast you drive and whether your acceleration and braking is mild or aggressive. Your route includes factors such as the amount of city or highway driving and road grades. Additional energy used due to heavy loads or trailer towing is also included here.

## **Accessories**

This includes energy used for low voltage accessories such as climate system fans, heated seats and lighting. Pro Power Onboard usage is also included.

## **Exterior Temperature**

This includes energy losses due to outside temperature and other conditions which reduce vehicle system efficiency.

# Remote Start

## WHAT IS REMOTE START

The system allows you to remotely start your vehicle and to adjust the interior temperature according to the settings that you chose.

**Note:** *If your vehicle is plugged in during the remote start operation, it will draw power from the power source and not the vehicle's battery.*

## REMOTE START PRECAUTIONS



**WARNING:** Do not keep electrical devices plugged in the power point whenever the device is not in use. Power points power up during remote start.

## REMOTE START LIMITATIONS

Remote start does not work under the following conditions:

- The alarm horn is sounding.
- The hood is open.
- The vehicle is not in park (P).
- The vehicle is on.
- Remote start has been disabled in the touchscreen.
- The high voltage or 12 volt battery is below the minimum operating voltage.

**Note:** *To use remote start with the Ford Pass, enable the modem. See **Enabling and Disabling the Modem** (page 485). To use remote start with Phone as a Key, enable the modem and set up Phone As A Key. See **Connecting Your Phone** (page 527).*

## ENABLING REMOTE START

1. Access the vehicle drawer on the touchscreen.
2. Press **SETTINGS**.
3. Press **Vehicle**.
4. Press **Remote Start Setup**.
5. Switch **Remote Start** on or off.

**Note:** *To remote start with FordPass or Phone as a Key, make sure that the modem is enabled and Phone as a Key is setup. See **Enabling and Disabling the Modem** (page 485). See **Connecting Your Phone** (page 527).*

## REMOTELY STARTING AND STOPPING THE VEHICLE

### Remotely Starting the Vehicle

Using your FordPass app, press and hold the start button within 131 ft (40 m) of the vehicle.

**Note:** *You can also use the phone as a key to start the vehicle.*

- The direction indicators flash twice.
- The parking lamps turn on when the vehicle is running.
- The horn sounds if the system fails to start.
- All other vehicle systems remain off when you have remotely started the vehicle.
- The vehicle remains secured when you have remotely started the vehicle. A valid key must be inside your vehicle to switch the vehicle on and drive your vehicle.

### Remotely Stopping the Vehicle

Using your FordPass app, press the remote stop button.



# Remote Start

---

**Note:** You can also use the phone as a key to stop the vehicle.

## EXTENDING THE REMOTE START DURATION

Using your FordPass app, press the button showing addition time.

**Note:** You can also use phone as a key to extend the remote start duration.

If the duration is set to 15 minutes, the duration extends by another 15 minutes. This provides a total of 30 minutes.

**Note:** Remote start can only be extended once.

**Note:** A maximum of two remote starts, or one remote start with an extension, are allowed. To reset the restart procedure switch the vehicle to on, then to off.

## REMOTE START SETTINGS

### Switching Climate Control Auto Mode On and Off

1. Access the vehicle drawer on the touchscreen.
2. Press **SETTINGS**.
3. Press **Vehicle**.
4. Press **Remote Start Setup**.
5. Press **Auto** or **Last settings**.

**Note:** If you switch the auto mode on, the system attempts to heat or cool the interior to 72°F (22°C). When you switch the vehicle on, the climate control system returns to the last used settings.

**Note:** If you switch the last settings on, the system remembers the last used settings.

### Heated Seat Settings (If Equipped)

1. Access the vehicle drawer on the touchscreen.

2. Press **SETTINGS**.
3. Press **Vehicle**.
4. Press **Remote Start Setup**.
5. Press **Seats**.
6. Press **Auto** or **Off**.

**Note:** If you switch the heated seat settings on, the heated seats turn on during cold weather.

### Heated Steering Wheel Settings (If Equipped)

1. Access the vehicle drawer on the touchscreen.
2. Press **SETTINGS**.
3. Press **Vehicle**.
4. Press **Remote Start Setup**.
5. Press **Seats and Steering Wheel**.
6. Press **Auto** or **Off**.

**Note:** If you switch the heated steering wheel settings on, the heated steering wheel turns on during cold weather.

### Remote Start Duration

1. Access the vehicle drawer on the touchscreen.
2. Press **SETTINGS**.
3. Press **Vehicle**.
4. Press **Remote Start Setup**.
5. Press **Duration**.
6. Press the duration you prefer.

## Climate Control - Vehicles With: 12.3 Inch Screen

### IDENTIFYING THE CLIMATE CONTROL UNIT



Depending on your vehicle options, the controls could look different than what you see here.

### SWITCHING CLIMATE CONTROL ON AND OFF



Press the button.

### SWITCHING RECIRCULATED AIR ON AND OFF



Press the button to recirculate air currently in the passenger compartment.

**Note:** *Recirculated air may turn off automatically, or prevent you from switching on in all air flow modes except MAX A/C to reduce the risk of fogging. Recirculation may also turn on and off automatically in various air distribution control combinations to improve heating or cooling efficiency.*

### SWITCHING AIR CONDITIONING ON AND OFF



Press the button.

**Note:** *Under certain conditions, the air conditioning compressor could continue to operate after you switch air conditioning off.*

**Note:** *To keep the system and its components fully functional, switch air conditioning on and let your vehicle idle at least once per month for a minimum of two minutes.*

### SWITCHING DEFROST ON AND OFF



Press the button to activate the selection screen.



Press the button on the touchscreen to switch the windshield air vents on.



Make sure that the instrument panel air vents are switched off.



Make sure that the footwell air vents are switched off.

### SWITCHING MAXIMUM DEFROST ON AND OFF



Press the button.

Air flows through the windshield air vents, and the blower motor adjusts to the highest speed.

You can also use this setting to defog and clear the windshield of a thin covering of ice.

**Note:** *To prevent window fogging, you cannot select recirculated air when maximum defrost is on.*

**Note:** *The heated rear window also turns on when you select maximum defrost.*

## Climate Control - Vehicles With: 12.3 Inch Screen

**Note:** When maximum defrost is on, the air conditioning compressor may continue to operate even though you switch off the air conditioning.

### SWITCHING MAXIMUM COOLING ON AND OFF

 Press the button.

**Note:** When you switch maximum cooling off, air conditioning remains on.

### SWITCHING THE HEATED REAR WINDOW ON AND OFF (IF EQUIPPED)

 Press the button to clear the rear window of thin ice and fog. The heated rear window turns off after a short period of time.

**Note:** Do not use harsh chemicals, razor blades or other sharp objects to clean or remove decals from the inside of the heated rear window as this could cause damage to the heated rear window grid lines not covered by the vehicle Warranty.

### SETTING THE BLOWER MOTOR SPEED



**Note:** The blower motor may run, and you may feel airflow when the climate control is off to provide cooling to the battery.

### SWITCHING THE HEATED MIRRORS ON AND OFF



Press the button.

### SETTING THE TEMPERATURE

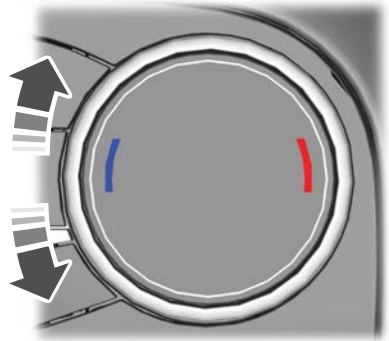

Turn the control on the left-hand side of the climate control to set the left-hand temperature.

**Note:** This control also sets the right-hand side temperature when you switch off dual zone mode.

Turn the control on the right-hand side of the climate control to set the right-hand temperature.

### DIRECTING THE FLOW OF AIR

#### Directing Air to the Windshield Air Vents



Press the button to activate the selection screen.

# Climate Control - Vehicles With: 12.3 Inch Screen



Press the button on the touchscreen.

## Directing Air to the Instrument Panel Air Vents



Press the button to activate the selection screen.



Press the button on the touchscreen.

## Directing Air to the Footwell Air Vents



Press the button to activate the selection screen.



Press the button on the touchscreen.

## AUTO MODE

### SWITCHING AUTO MODE ON AND OFF



Press the button to switch auto mode on. Repeatedly press the button to adjust auto mode.

**Note:** When you switch auto mode on, lights on the blower motor control do not illuminate to indicate the blower motor speed.

Adjust the blower motor control or air distribution control to switch auto mode off.

### AUTO MODE INDICATORS

The indicators are on the Auto Mode button.

Auto Mode Indicator Status	Description
One indicator illuminated.	The blower motor speed is reduced. Use this setting to minimize the amount of noise from the blower motor. This setting increases the time taken to cool the interior.
Two indicators illuminated.	The blower motor speed is moderate.
Three indicators illuminated.	The blower motor speed is increased. Use this setting to reduce the time taken to cool the interior. This setting increases the amount of noise from the blower motor.

# Climate Control - Vehicles With: 12.3 Inch Screen

## SWITCHING DUAL MODE ON AND OFF



Press the button.

## DRIVER FOCUSED MODE

### HOW DOES DRIVER FOCUSED MODE WORK

When active, driver focused mode automatically shuts off the floor duct on the front passenger side when the front passenger occupancy seat sensor detects no one is on the front passenger seat.

### DRIVER FOCUSED MODE LIMITATIONS

The system does not function in the following conditions:

- The outside ambient temperature is 5.0°F (-15°C) or less.
- Defrost or Max Defrost mode is selected.
- Any of the required sensor readings are faulty or disabled.

## SWITCHING DRIVER FOCUSED MODE ON AND OFF



Press the button on the touchscreen to access the climate controls.

Press **Driver Focused**.

When active, driver focused mode switches off when any of the following occur:

- You switch it off in the touchscreen.
- You switch dual mode on.

- You adjust the passenger temperature.
- You adjust the passenger heated or cooled seat settings.

## CLIMATE CONTROL HINTS

### General Hints

- Use of the climate system will reduce your vehicles driving range. Conserve battery charge by using climate control features when necessary.
- Prolonged use of recirculated air may cause the windows to fog up.
- You may feel a small amount of air from the footwell air vents regardless of the air distribution setting.
- To reduce humidity build-up inside your vehicle, do not drive with the system switched off or with recirculated air always switched on.
- Remove any snow, ice or leaves from the air intake area at the base of the windshield.
- To improve the time to reach a comfortable temperature in hot weather, drive with the windows open until you feel cold air through the air vents.

### Automatic Climate Control

- Adjusting the settings when your vehicle interior is extremely hot or cold is not necessary. Automatic mode is best recommended to maintain set temperature.
- The system adjusts to heat or cool the interior to the temperature you select as quickly as possible.
- For the system to function efficiently, the instrument panel and side air vents should be fully open.

## Climate Control - Vehicles With: 12.3 Inch Screen

---

- If you press **AUTO** during cold outside temperatures, the system directs air flow to the windshield and side window air vents. The blower motor speed may reduce until the air warms.
  - If you press **AUTO** during hot temperatures and the inside of the vehicle is hot, the system uses recirculated air to maximize interior cooling. Blower motor speed may also reduce until the air cools.
2. Adjust the temperature control to the setting you prefer. Use 72°F (22°C) as a starting point, then adjust the setting as necessary.

### Quickly Heating the Interior

1. Press **AUTO**.
2. Adjust the temperature function to the setting you prefer.

### Recommended Settings for Heating

1. Press **AUTO**.
2. Adjust the temperature function to the setting you prefer. Use 72°F (22°C) as a starting point, then adjust the setting as necessary.

### Quickly Cooling the Interior

Press **MAX A/C**.

### Recommended Settings for Cooling

1. Press **AUTO**.
2. Adjust the temperature function to the setting you prefer. Use 72°F (22°C) as a starting point, then adjust the setting as necessary.

### Defogging the Side Windows in Cold Weather

1. Press and release defrost or maximum defrost.

# Climate Control - Vehicles With: 15 Inch Screen

## IDENTIFYING THE CLIMATE CONTROL UNIT



Use the controls in this area to change the climate inside of your vehicle.

Depending on your vehicle options, the controls could look different than what you see here.

## SWITCHING CLIMATE CONTROL ON AND OFF



Press the button to access the climate controls.



Press the button.

## SWITCHING RECIRCULATED AIR ON AND OFF



Press the button to access the climate controls.



Press the button to recirculate air currently in the passenger compartment.

**Note:** Recirculated air may turn off automatically, or prevent you from switching on in all air flow modes except MAX A/C to reduce the risk of fogging. Recirculation may also turn on and off automatically in various air distribution control combinations to improve heating or cooling efficiency.

## SWITCHING AIR CONDITIONING ON AND OFF



Press the button.

**Note:** Under certain conditions, the air conditioning compressor could continue to operate after you switch air conditioning off.

**Note:** To keep the system and its components fully functional, switch air conditioning on and let your vehicle idle at least once per month for a minimum of two minutes.

## SWITCHING DEFROST ON AND OFF



Press the button to access the climate controls.



Press the button.

## SWITCHING MAXIMUM DEFROST ON AND OFF



Press the button.

Air flows through the windshield air vents, the temperature is set to the highest setting, and the blower motor adjusts to the highest speed.

# Climate Control - Vehicles With: 15 Inch Screen

You can also use this setting to defog and clear the windshield of a thin covering of ice.

**Note:** To prevent window fogging, you cannot select recirculated air when maximum defrost is on.

**Note:** The heated rear window and heated mirrors also turn on when you select maximum defrost.

**Note:** When maximum defrost is on, the air conditioning compressor may continue to operate even though you switch off the A/C.

## SWITCHING MAXIMUM COOLING ON AND OFF



Press the button to access the climate controls.



Press the button.

**Note:** When you switch maximum cooling off, air conditioning remains on.

**Note:** In certain conditions, for example, cold weather, maximum cooling may not activate or could run slow when switched on. This helps reduce power consumption from the battery.

## SWITCHING THE ELECTRIC HEATER ON AND OFF

When E-Heat is on, an electric heater warms the cabin and keeps the windows from fogging. Turning E-Heat off saves battery power, which extends your driving range. The electric heater is the only source of heat to warm the cabin.



Press the button to access the climate controls.



Press the button to switch the electric heater on or off.

**Note:** The default setting is on.

**Note:** Disabling the system helps maximize your driving range.

**Note:** The system does not work in some climate control modes.

**Note:** This button does not switch off the climate control system.

**Note:** In certain conditions, for example warm weather, the system could not activate or could run with reduced performance when switched on.

## SWITCHING THE HEATED REAR WINDOW ON AND OFF



Press the button to clear the rear window of thin ice and fog. The heated rear window turns off after a short period of time.

**Note:** Do not use harsh chemicals, razor blades or other sharp objects to clean or remove decals from the inside of the heated rear window as this could cause damage to the heated rear window grid lines not covered by the vehicle Warranty.

## SETTING THE BLOWER MOTOR SPEED



Press the button to switch the blower motor on.



Slide the control to set the blower motor speed.



## Climate Control - Vehicles With: 15 Inch Screen

### SWITCHING THE HEATED MIRRORS ON AND OFF

When you switch the heated rear window on, the heated exterior mirrors turn on.

**Note:** Do not remove ice from the mirrors with a scraper or adjust the mirror glass when it is frozen in place.

**Note:** Do not clean the mirror housing or glass with harsh abrasives, fuel or other petroleum-based cleaning products. The vehicle warranty may not cover damage caused to the mirror housing or glass.

### SETTING THE TEMPERATURE

Press the temperature controls on either side of the climate control to set the temperature for that side.



Slide the control to set the temperature.

**Note:** You can press + or - to set the temperature.

### DIRECTING THE FLOW OF AIR

#### Directing Air to the Windshield Air Vents



Press the button on the touchscreen to access the climate controls.



Press the button.

#### Directing Air to the Instrument Panel Air Vents



Press the button on the touchscreen to access the climate controls.



Press the button.

#### Directing Air to the Footwell Air Vents



Press the button on the touchscreen to access the climate controls.



Press the button.

### AUTO MODE

#### SWITCHING AUTO MODE ON AND OFF



Press the button to switch auto mode on. Repeatedly press the button to adjust auto mode.

Adjust the blower motor control or air distribution control to switch auto mode off.

#### AUTO MODE INDICATORS

The indicators are on the Auto Mode button.

## Climate Control - Vehicles With: 15 Inch Screen

---

<b>Auto Mode Indicator Status</b>	<b>Description</b>
One indicator illuminated.	The blower motor speed is reduced. Use this setting to minimize the amount of noise from the blower motor. This setting increases the time taken to cool the interior.
Two indicators illuminated.	The blower motor speed is moderate.
Three indicators illuminated.	The blower motor speed is increased. Use this setting to reduce the time taken to cool the interior. This setting increases the amount of noise from the blower motor.

# Climate Control - Vehicles With: 15 Inch Screen

## SWITCHING DUAL MODE ON AND OFF



Press the button to access the climate controls.



Press the button.

**Note:** When dual mode is off, setting the temperature using the driver side controls, sets the temperature for both sides.

**Note:** Setting the temperature using the passenger side controls, sets the passenger temperature and switches dual mode on.

## DRIVER FOCUSED MODE

### HOW DOES DRIVER FOCUSED MODE WORK

When active, driver focused mode automatically shuts off the floor duct on the front passenger side when the front passenger occupancy seat sensor detects no one is on the front passenger seat.

### DRIVER FOCUSED MODE LIMITATIONS

The system does not function in the following conditions:

- The outside ambient temperature is 5.0°F (-15°C) or less.
- Defrost or Max Defrost mode is selected.
- Any of the required sensor readings are faulty or disabled.

## SWITCHING DRIVER FOCUSED MODE ON AND OFF



Press the button on the touchscreen to access the climate controls.

Press **Driver Focused**.

When active, driver focused mode switches off when any of the following occur:

- You switch it off in the touchscreen.
- You switch dual mode on.
- You adjust the passenger temperature.
- You adjust the passenger heated or cooled seat settings.

## CLIMATE CONTROL HINTS

### General Hints

- Use of the climate system will reduce your vehicles driving range. Conserve battery charge by using climate control features when necessary.
- Prolonged use of recirculated air may cause the windows to fog up.
- You may feel a small amount of air from the footwell air vents regardless of the air distribution setting.
- To reduce humidity build-up inside your vehicle, do not drive with the system switched off or with recirculated air always switched on.
- Remove any snow, ice or leaves from the air intake area at the base of the windshield.
- To improve the time to reach a comfortable temperature in hot weather, drive with the windows open until you feel cold air through the air vents.

# Climate Control - Vehicles With: 15 Inch Screen

---

## Automatic Climate Control

- Adjusting the settings when your vehicle interior is extremely hot or cold is not necessary. Automatic mode is best recommended to maintain set temperature.
- The system adjusts to heat or cool the interior to the temperature you select as quickly as possible.
- For the system to function efficiently, the instrument panel and side air vents should be fully open.
- If you press **AUTO** during cold outside temperatures, the system directs air flow to the windshield and side window air vents. The blower motor speed may reduce until the air warms.
- If you press **AUTO** during hot temperatures and the inside of the vehicle is hot, the system uses recirculated air to maximize interior cooling. Blower motor speed may also reduce until the air cools.

2. Adjust the temperature function to the setting you prefer. Use 72°F (22°C) as a starting point, then adjust the setting as necessary.

## Defogging the Side Windows in Cold Weather

1. Press and release defrost or maximum defrost.
2. Adjust the temperature control to the setting you prefer. Use 72°F (22°C) as a starting point, then adjust the setting as necessary.

## Quickly Heating the Interior

1. Press **AUTO**.
2. Adjust the temperature function to the setting you prefer.

## Recommended Settings for Heating

1. Press **AUTO**.
2. Adjust the temperature function to the setting you prefer. Use 72°F (22°C) as a starting point, then adjust the setting as necessary.

## Quickly Cooling the Interior

Press **MAX A/C**.

## Recommended Settings for Cooling

1. Press **AUTO**.

# Interior Air Quality

## WHAT IS THE CABIN AIR FILTER

The cabin air filter improves the quality of air in your vehicle by trapping dust, pollen and other particles.

## REPLACING THE CABIN AIR FILTER

Replace the filter at regular intervals.

The cabin air filter is behind the glove compartment.

To remove the lower glove compartment and access the filter:

1. Open the glove compartment.

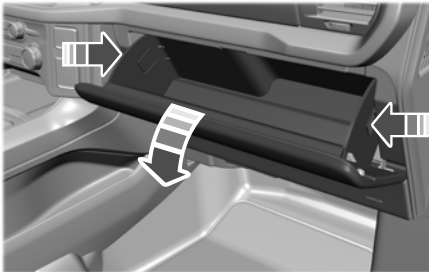

2. Press the tab on each side.
3. Fully lower the glove compartment.
4. Pull the glove compartment toward you.
5. Unclip both sides of the filter door and swing door down to access filter .

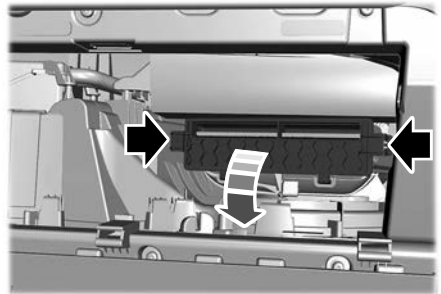

6. Remove the old filter and replace with a new filter.

# Front Seats

## FRONT SEAT PRECAUTIONS

**WARNING:** Sitting improperly, out of position or with the seatback reclined too far can take weight off the seat cushion and affect the decision of the passenger sensing system, resulting in serious injury or death in the event of a crash. Always sit upright against your seat back, with your feet on the floor.

**WARNING:** Do not recline the seat backrest too far as this can cause the occupant to slide under the seatbelt, resulting in personal injury in the event of a crash.

**WARNING:** Do not place objects higher than the top of the seat backrest. Failure to follow this instruction could result in personal injury or death in the event of a sudden stop or crash.

**WARNING:** Do not adjust the driver seat or seat backrest when your vehicle is moving. This may result in sudden seat movement, causing the loss of control of your vehicle.

**WARNING:** It is extremely dangerous to ride in a cargo area, inside or outside of a vehicle. In a crash, people riding in these areas are more likely to be seriously injured or killed. Do not allow people to ride in any area of your vehicle that is not equipped with seats and seatbelts. Make sure everyone in your vehicle is in a seat and properly using a seatbelt. Failure to follow this warning could result in serious personal injury or death.

**WARNING:** All occupants of your vehicle, including the driver, should always keep their whole body inside the vehicle when it is moving.

## SITTING IN THE CORRECT POSITION

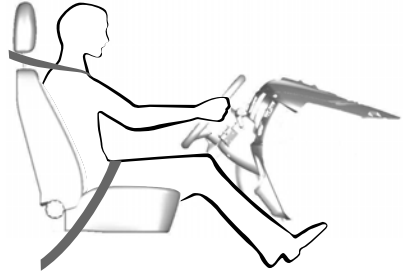

When you use them properly, the seat, head restraint, seatbelt and airbags will provide optimum protection in the event of a crash.

We recommend that you follow these guidelines:

- Sit in an upright position with the base of your spine as far back as possible.
- Do not recline the seat backrest so that your torso is more than 30 degrees from the upright position.
- Adjust the head restraint so that the top of it is level with the top of your head and as far forward as possible. Make sure that you remain comfortable.
- Keep sufficient distance between yourself and the steering wheel. We recommend a minimum of 10 in (25 cm) between your breastbone and the airbag cover.
- Hold the steering wheel with your arms slightly bent.

# Front Seats

- Bend your legs slightly so that you can press the pedals fully.
- Position the shoulder strap of the seatbelt over the center of your shoulder and position the lap strap tightly across your hips.

Make sure that your driving position is comfortable and that you can maintain full control of your vehicle.

## MANUAL SEATS (IF EQUIPPED)

### HEADRESTRAINT COMPONENTS

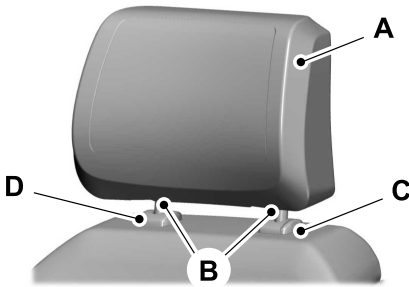

The head restraints consist of:

- A An energy absorbing head restraint.
- B Two steel stems.
- C Guide sleeve adjust and release button.
- D Guide sleeve unlock and remove button (If equipped).

### ADJUSTING THE HEAD RESTRAINT

**⚠ WARNING:** Fully adjust the head restraint before you sit in or operate your vehicle. This will help minimize the risk of neck injury in the event of a crash. Do not adjust the head restraint when your vehicle is moving.

**⚠ WARNING:** The head restraint is a safety device. Whenever possible it should be installed and properly adjusted when the seat is occupied. Failure to adjust the head restraint properly could reduce its effectiveness during certain impacts.

**⚠ WARNING:** Adjust the head restraints for all passengers before you drive your vehicle. This will help minimize the risk of neck injury in the event of a crash. Do not adjust the head restraints when your vehicle is moving.

**Note:** *Adjust the seat backrest to an upright driving position before adjusting the head restraint. Adjust the head restraint so that the top of it is level with the top of your head and as far forward as possible. Make sure that you remain comfortable. If you are extremely tall, adjust the head restraint to its highest position.*

Pull the head restraint up to raise it.

To lower the head restraint:

1. Press and hold the adjust and release button.
2. Push the head restraint down.

# Front Seats

## REMOVING THE HEAD RESTRAINT

1. Pull up the head restraint until it reaches the highest adjustment position.
2. Press and hold the adjust and release button and the unlock and remove button.
3. Pull up the head restraint.

**Note:** You cannot remove head restraints that have audio system speakers.

## INSTALLING THE HEAD RESTRAINT

Align the steel stems into the guide sleeves and push the head restraint down until it locks.

## MOVING THE SEAT BACKWARD AND FORWARD

**WARNING:** Make sure the seat fully locks into place by rocking it backward and forward. Not securing the seat into the locked position can be dangerous in a crash and could cause serious personal injury or death.



## ADJUSTING THE SEAT BACKREST

**WARNING:** Always drive and ride with your seatback upright and the lap belt snug and low across the hips.

**WARNING:** Do not place cargo or any objects behind the seat backrest before returning it to the original position. Pull on the seat backrest to make sure that it has fully latched after returning the seat backrest to its original position. An unlatched seat may become dangerous if you stop suddenly or have a crash.



## ADJUSTING THE LUMBAR SUPPORT

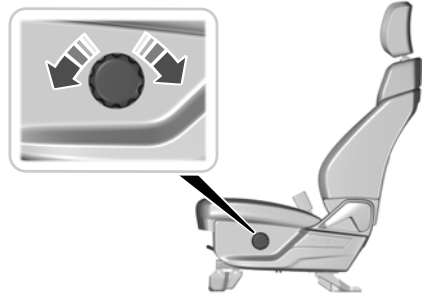



# Front Seats

## POWER SEATS (IF EQUIPPED)

### HEADRESTRAINT COMPONENTS

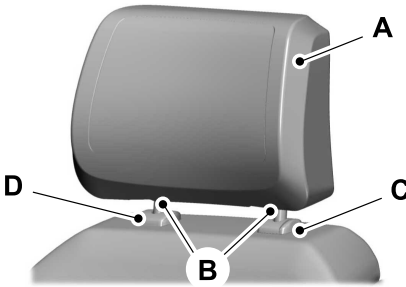

The head restraints consist of:

- A An energy absorbing head restraint.
- B Two steel stems.
- C Guide sleeve adjust and release button.
- D Guide sleeve unlock and remove button (If equipped).

### ADJUSTING THE HEAD RESTRAINT

**WARNING:** Fully adjust the head restraint before you sit in or operate your vehicle. This will help minimize the risk of neck injury in the event of a crash. Do not adjust the head restraint when your vehicle is moving.

**WARNING:** The head restraint is a safety device. Whenever possible it should be installed and properly adjusted when the seat is occupied. Failure to adjust the head restraint properly could reduce its effectiveness during certain impacts.

**WARNING:** Adjust the head restraints for all passengers before you drive your vehicle. This will help minimize the risk of neck injury in the event of a crash. Do not adjust the head restraints when your vehicle is moving.

To raise the head restraint, pull the head restraint up.

To lower the head restraint:

1. Press and hold the adjust and release button.
2. Push the head restraint down.

### Tilting the Head Restraint (If Equipped)



1. Adjust the seat backrest to an upright driving or riding position.
2. Pivot the head restraint forward toward your head to the preferred position.

# Front Seats

After the head restraint reaches the forward-most tilt position, pivot it forward again to release it to the rearward, untilted position.

**Note:** Do not attempt to force the head restraint backward after it is tilted. Instead, continue tilting it forward until the head restraint releases to the upright position.

## REMOVING THE HEAD RESTRAINT

1. Pull up the head restraint until it reaches its highest position.
2. Press and hold the adjust and release button and the unlock and remove button.
3. Pull up the head restraint.

**Note:** You cannot remove head restraints that have audio system speakers.

## INSTALLING THE HEAD RESTRAINT

Align the steel stems into the guide sleeves and push the head restraint down until it locks.

## MOVING THE SEAT BACKWARD AND FORWARD

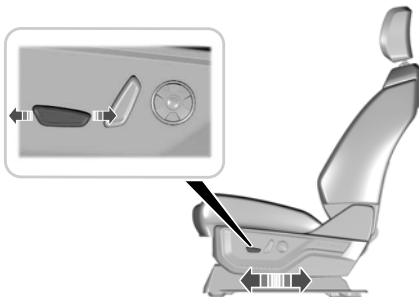

If the seat stops prior to reaching the end of the travel position, or an obstruction occurs, a new stopping position is learned.

To reset the stopping position:

1. Remove any obstruction.
2. Press and hold the control until the seat stops moving.
3. Press and hold the control again until the seat stops.
4. Continue holding the control for a few seconds. The new position is learned.

## ADJUSTING THE SEAT CUSHION

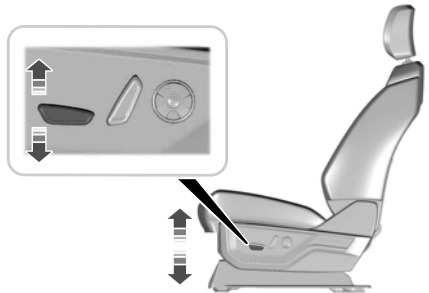

## ADJUSTING THE SEAT BACKREST

**WARNING:** Always drive and ride with your seatback upright and the lap belt snug and low across the hips.

# Front Seats

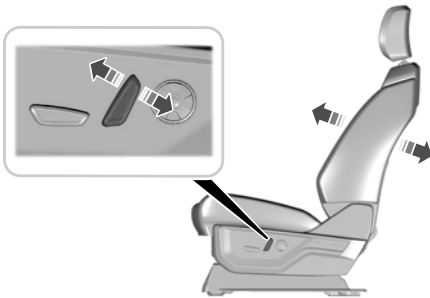

## Adjusting the Seat Flat (If Equipped)

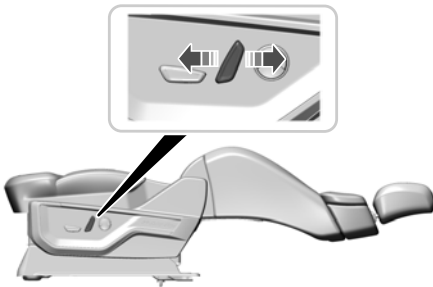

This feature allows the occupant to find a comfortable position to rest when the vehicle is not moving.

**Note:** Before adjusting the seat backrest fully flat, place the rear seat cushion into the upright position and remove any objects that could obstruct the movement of the flat seat. See **Folding the Seats** (page 171).

As the seat folds flat, the cushion adjusts to support the hips and lower back. For additional support, you can also adjust the upper seat backrest.

If you fully recline the passenger seat and the vehicle is moving, a message appears on the instrument cluster and a tone sounds. To switch the warning off, return the seat to an upright position.

## Adjusting the Upper Seat Backrest (If Equipped)

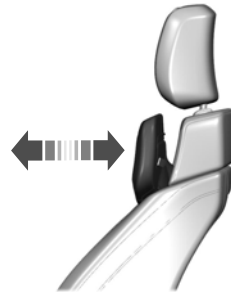

The front upper seat backrest tilts for extra comfort. To tilt the upper seat backrest, pivot the upper seat backrest toward your shoulders.

After the upper seat backrest reaches the forward-most tilt position, pivot it forward again to release it to the rearward, untilted position.

## ADJUSTING THE SEAT HEIGHT

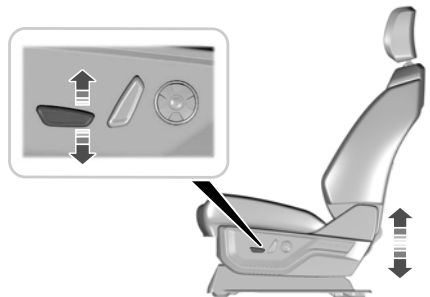

## Front Seats

### ADJUSTING THE LUMBAR SUPPORT

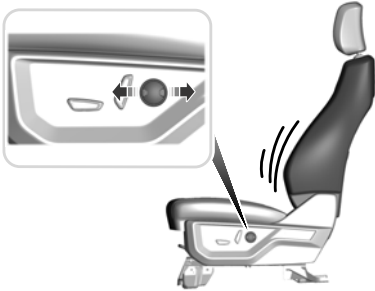

### ADJUSTING THE MASSAGE SEAT SETTINGS

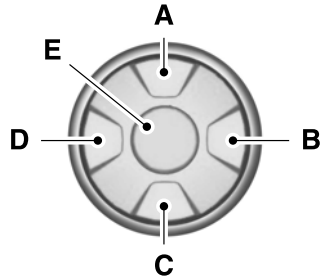

### MASSAGE SEATS (IF EQUIPPED)

#### MASSAGE SEAT LIMITATIONS

The vehicle must be running or be in accessory mode to activate the seats.

The passenger side massage is available if the occupant meets the seat sensor weight requirements.

Allow a few seconds for any selection to activate. Selecting a different adjustment cancels the current one in progress. When the seat backrest and cushion are both active, the massage alternates between zones.

- A Select the previous massage pattern or lumbar area.
- B Decrease the massage or lumbar Intensity.
- C Select the next massage pattern or lumbar area.
- D Increase the massage or lumbar Intensity.
- E Select the massage or lumbar mode.

You can also adjust this feature through the touchscreen.

# Front Seats

## HEATED SEATS (IF EQUIPPED)

### HEATED SEAT PRECAUTIONS



**WARNING:** Use caution when using the heated seat if you are unable to feel pain to your skin because of advanced age, chronic illness, diabetes, spinal cord injury, medication, alcohol use, exhaustion or other physical conditions. The heated seat could cause burns even at low temperatures, especially if used for long periods of time. Failure to follow this instruction could result in personal injury.



**WARNING:** Do not poke sharp objects into the seat cushion or seat backrest. This could damage the heated seat element and cause it to overheat. Failure to follow this instruction could result in personal injury.



**WARNING:** Do not place anything on the seat that blocks the heat, for example a seat cover or a cushion. This could cause the seat to overheat. Failure to follow this instruction could result in personal injury.

Do not:

- Place heavy objects on the seat.
- Operate the heated seat if water or any other liquid spills on the seat. Allow the seat to dry.

### SWITCHING THE HEATED SEATS ON AND OFF - VEHICLES WITH: 12.3 INCH SCREEN

The vehicle must be running to use this feature.



Press the symbol on the climate controls to cycle through the various heat settings and off. The more indicators that display, the warmer the temperature of the seat.

**Note:** The heated seats may remain on after you remote start your vehicle, based on your remote start settings.

**Note:** The heated seats may switch on when you start your vehicle if they were on when you switched your vehicle off.

### SWITCHING THE HEATED SEATS ON AND OFF - VEHICLES WITH: 15 INCH SCREEN

The vehicle must be running to use this feature.

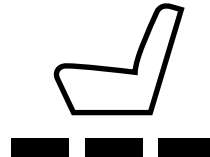

Press the seat symbol on the touchscreen to switch on the heated seats. Then, slide the menu bar up to control the heat intensity. The more indicators that display, the warmer the temperature of the seat.

**Note:** The heated seats may remain on after you remote start your vehicle, based on your remote start settings.

# Front Seats

---

**Note:** The heated seats may turn on when you start your vehicle if they were on when you switched your vehicle off.

**Note:** Select Auto to heat your seat based on your climate control settings, humidity and air temperature.

**Note:** The ventilated seats may switch on when you start your vehicle if they were on when you previously switched your vehicle off.

**Note:** Select Auto to ventilate your seat based on your climate control settings, humidity and air temperature.

## VENTILATED SEATS (IF EQUIPPED)

### VENTILATED SEAT PRECAUTIONS

Do not:

- Spill liquid on the front seats. This may cause the air vent holes to become blocked and not work properly.
- Place cargo or objects under the seats. They may block the air intake causing the air vents to not work properly.

### SWITCHING THE VENTILATED SEATS ON AND OFF

The vehicle must be running to use this feature.



Press the seat symbol on the touchscreen to switch on the cooled seats. Then, slide the menu bar down to control the fan speed. More indicator lights indicate higher fan speeds.

**Note:** The ventilated seats switch on during a remote start if they are enabled.

## Rear Seats (If Equipped)

### MANUAL SEATS

#### HEADRESTRAINT COMPONENTS

##### Rear Seat Outermost Head Restraints

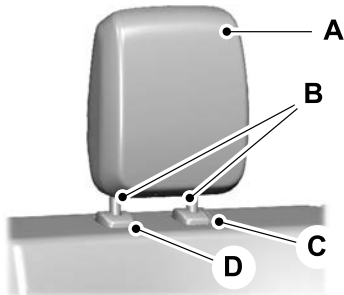

##### Rear Seat Center Head Restraint

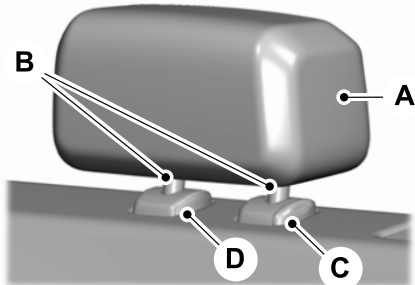

The head restraints consist of:

- A An energy absorbing head restraint.
- B Two steel stems.
- C Guide sleeve adjust and release button.
- D Guide sleeve unlock and remove button (If equipped).

#### ADJUSTING THE HEAD RESTRAINT

Pull the head restraint up to raise it.

To lower the head restraint:

1. Press and hold the adjust and release button.
2. Push the head restraint down.

#### REMOVING THE HEAD RESTRAINT

1. Pull up the head restraint until it reaches its highest position.
2. Press and hold the adjust and release button and the unlock and remove button.
3. Pull up the head restraint.

#### INSTALLING THE HEAD RESTRAINT

Align the steel stems into the guide sleeves and push the head restraint down until it locks.

#### FOLDING THE SEATS

You can flip each seat cushion up into a vertical storage position.

## Rear Seats (If Equipped)



Rotate the seat up until it locks in place.

### UNFOLDING THE SEATS

**WARNING:** Make sure that cargo and other objects are not trapped under the seat cushion and that you return the seat cushion to the full-down position. Failure to do so may prevent the seat from operating properly, which could increase the risk of serious injury in a crash.



### HEATED SEATS (IF EQUIPPED)

#### HEATED SEAT PRECAUTIONS

**WARNING:** Use caution when using the heated seat if you are unable to feel pain to your skin because of advanced age, chronic illness, diabetes, spinal cord injury, medication, alcohol use, exhaustion or other physical conditions. The heated seat could cause burns even at low temperatures, especially if used for long periods of time. Failure to follow this instruction could result in personal injury.

**WARNING:** Do not poke sharp objects into the seat cushion or seat backrest. This could damage the heated seat element and cause it to overheat. Failure to follow this instruction could result in personal injury.

**WARNING:** Do not place anything on the seat that blocks the heat, for example a seat cover or a cushion. This could cause the seat to overheat. Failure to follow this instruction could result in personal injury.

Do not:

- Place heavy objects on the seat.
- Operate the heated seat if water or any other liquid spills on the seat. Allow the seat to dry.

#### SWITCHING THE HEATED SEATS ON AND OFF

The vehicle must be running to use this feature.

The rear seat heat controls are on the rear of the center console.



## Rear Seats (If Equipped)

---



Press the heated seat symbol to cycle through the various heat settings and off. More indicator lights indicate warmer settings.

The heated seats turn off when you switch off the vehicle.

## Rear Occupant Alert System (If Equipped)

### WHAT IS THE REAR OCCUPANT ALERT SYSTEM

The rear occupant alert system monitors vehicle conditions and notifies you to check for rear seat occupants when you switch the ignition off.

### HOW DOES THE REAR OCCUPANT ALERT SYSTEM WORK

The system monitors when rear doors have been opened and closed to indicate the potential presence of an occupant in the rear seat.

A message displays in the information and entertainment display screen and an audible warning sounds when you switch the ignition off after any of the following conditions have been met:

- A rear door is opened or closed while the ignition is on.
- You switch the ignition on within 15 minutes of a rear door opening and closing.
- You switch the ignition on within 15 minutes of the alert having displayed or sounded.

### REAR OCCUPANT ALERT SYSTEM PRECAUTIONS



**WARNING:** On hot days, the temperature inside the vehicle can rise very quickly. Exposure of people or animals to these high temperatures for even a short time can cause death or serious heat related injuries, including brain damage. Small children are particularly at risk.



**WARNING:** Do not leave children or pets unattended in your vehicle. Failure to follow this instruction could result in personal injury or death.

### REAR OCCUPANT ALERT SYSTEM LIMITATIONS

The system does not detect the presence of objects or passengers in the rear seat. It monitors when rear doors are opened and closed.

**Note:** *It is possible to receive an alert when there is no rear seat occupant, but alert conditions are met.*

**Note:** *It is possible to receive no alert when there is an occupant in the rear seat, if alert conditions are not met. For example, if a rear seat occupant does not enter the vehicle through a rear door.*

**Note:** *The audible warning does not sound when the front door is opened before you switch the ignition off.*

### SWITCHING REAR OCCUPANT ALERT SYSTEM ON AND OFF - VEHICLES WITH: 12.3 INCH SCREEN

1. Press **Settings** on the touchscreen.
2. Press **Vehicle**.
3. Switch **Rear Occupant Alert** on or off.

**Note:** *The default setting is on.*

**Note:** *Performing a master reset causes the system to switch on again.*

# Rear Occupant Alert System (If Equipped)

## Semiannual Reminder

When you switch the system off, a message appears every six months as a reminder that the system is off. You can switch the system back on or leave it off.

## SWITCHING REAR OCCUPANT ALERT SYSTEM ON AND OFF - VEHICLES WITH: 15 INCH SCREEN

1. Access the vehicle drawer on the touchscreen.
2. Press **SETTINGS**.
3. Press **Vehicle**.
4. Switch **Rear Occupant Alert** on or off.

**Note:** The default setting is on.

**Note:** Performing a master reset causes the system to switch on again.

## Semiannual Reminder

When you switch the system off, a message appears every six months as a reminder that the system is off. You can switch the system back on or leave it off.

## REAR OCCUPANT ALERT SYSTEM INDICATORS

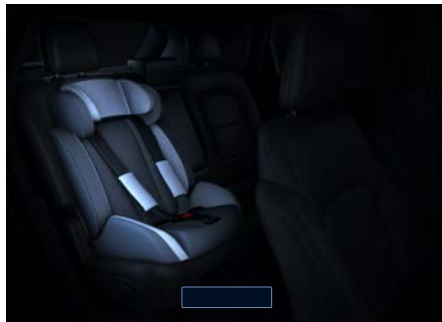

Message
Check rear seats for occupants.

Displays when you switch your vehicle off after the alert conditions are met.

The message displays for a short period of time. Press **Close** to acknowledge and remove the message.

**Note:** Depending on your SYNC version, the graphic may look different from what you see here.

## REAR OCCUPANT ALERT SYSTEM AUDIBLE WARNINGS

Sounds when you switch your vehicle off after the alert conditions are met.

The warning sounds for a short period of time.

# Memory Function (If Equipped)

## WHAT IS THE MEMORY FUNCTION

The memory function recalls the position of these features:

- Driver seat.
- Power mirrors.
- Optional power steering column.
- Optional power adjustable pedals.

## MEMORY FUNCTION PRECAUTIONS

**WARNING:** Before activating the memory seat, make sure that the area immediately surrounding the seat is clear of obstructions and that all occupants are clear of moving parts.

**WARNING:** Do not use the memory function when your vehicle is moving.

## LOCATING THE MEMORY FUNCTION BUTTONS



The memory function buttons are on the driver door.

## SAVING A PRESET POSITION

1. Adjust the memory features to your preferred position.
2. Press and hold the preferred preset button until you hear a single tone.

A confirmation message appears in the information display.

You can save up to three preset memory positions at any time.

## RECALLING A PRESET POSITION

Press and release a preset button.

**Note:** You can recall a preset memory position when the ignition is off, or when you place the transmission in park (P) or neutral (N) if the ignition is on and the vehicle is not moving.

**Note:** Pressing any of the preset buttons or any memory feature control during a memory recall cancels the operation.

You can also recall a preset memory position by:

- Pressing the unlock button on your remote control if you linked it to a preset position.
- Unlocking the intelligent driver door handle if a linked remote control is present.

Using a linked remote control to recall your memory position when the ignition is off moves the seat and steering column to the easy entry position.

## Linking a Preset Position to Your Remote Control or Passive Key

See **Linking or Unlinking a Personal Profile to a Remote Control** (page 543).

# Garage Door Opener (If Equipped)

## GARAGE DOOR OPENER INTRODUCTION

### HomeLink Wireless Control System

The universal garage door opener replaces the common handheld garage door opener with a three-button transmitter integrated into the driver-side sun visor.



### How Does The Garage Door Opener Work

The system includes two primary features, a garage door opener and a platform for remote activation of devices within the home. You can program garage doors as well as entry gate operators, security systems, entry door locks and home or office lighting.

Additional assistance can be found online at [www.homelink.com/Ford](http://www.homelink.com/Ford) or by calling the toll-free help line at 1-800-355-3515.

**Note:** You can program a maximum of three devices. To change or replace any of the three devices after they have been initially programmed, you must either clear all codes, or reprogram each individual button. See **Programming the Garage Door Opener** (page 178).

## Garage Door Opener Limitations

Canadian radio-frequency laws require transmitter signals to time out, or quit, after several seconds – which may not be long enough for HomeLink to pick up the signal. U.S. gate operators time-out in the same manner.

## GARAGE DOOR OPENER PRECAUTIONS AND FREQUENCIES

### Garage Door Opener Precautions

**WARNING:** Do not use the system with any garage door opener that does not have the safety stop and reverse feature as required by U.S. Federal Safety Standards (this includes any garage door opener manufactured before April 1, 1982). A garage door opener which cannot detect an object, signaling the door to stop and reverse, does not meet current federal safety standards. Using a garage door opener without these features increases the risk of serious injury or death.

**Note:** Make sure that the garage door and security device are free from obstruction when you are programming. Do not program the system with the vehicle in the garage.

**Note:** Make sure you keep the original remote control transmitter for use in other vehicles as well as for future system programming.

**Note:** We recommend that upon the sale or lease termination of your vehicle, you erase the programmed function buttons for security reasons. See **Programming the Garage Door Opener** (page 178).

## Garage Door Opener (If Equipped)

### FCC and RSS-210 Industry Canada Compliance



**WARNING:** Changes or modifications not expressly approved by the party responsible for compliance could void the user's authority to operate the equipment. The term "IC:" before the radio certification number only signifies that Industry Canada technical specifications were met.

This device complies with Part 15 of the FCC Rules and with RSS-210 of Industry Canada. Operation is subject to the following two conditions: (1) this device may not cause harmful interference, and (2) this device must accept any interference received, including interference that may cause undesired operation.

This equipment complies with FCC radiation exposure limits set forth for an uncontrolled environment. End Users must follow the specific operating instructions for satisfying RF exposure compliance. This transmitter must be at least 8 in (20 cm) from the user and must not be co-located or operating in conjunction with any other antenna or transmitter.

### PROGRAMMING THE GARAGE DOOR OPENER

To clear all stored codes in the garage door opener in your vehicle, use the **clear** function. To override one button, use the **reprogram** function.

### Clearing the Garage Door Opener

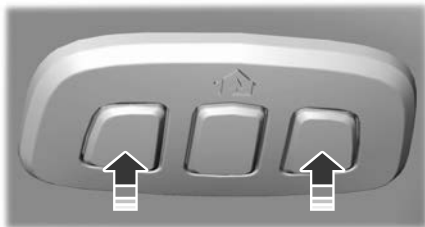

To clear all stored codes in the garage door opener in the vehicle:

1. Press and hold the outer two function buttons simultaneously for approximately 10 seconds until the indicator above the buttons flashes rapidly.
2. When the indicator flashes, release the buttons.

**Note:** *This clears all stored codes.*

### Reprogramming the Garage Door Opener

If a button on your garage door opener has already been programmed, you can override it. To program a device to a previously trained button:

1. Press and hold the desired button for approximately 20 seconds until the indicator begins to flash.
2. Proceed to the programming steps.

## Garage Door Opener (If Equipped)

### Programming the Garage Door Opener to your Handheld Transmitter

**Note:** The programming steps below assume you are programming a HomeLink that was not previously programmed. If your HomeLink was previously programmed, you may need to **clear** or **reprogram** your HomeLink buttons.

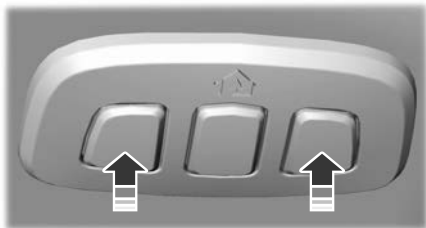

To program your in-vehicle HomeLink function button with your handheld transmitter:

1. With your vehicle parked outside of the garage, switch your vehicle on, but do not start your vehicle.
2. Press and release one of the three HomeLink function buttons that you would like to program.

**Note:** The indicator should begin to flash. If the indicator does not flash, press and hold the function button for 20 seconds until the indicator begins to flash.

3. Hold your handheld garage door transmitter 1–3 in (2–8 cm) away from the HomeLink button you want to program.

4. Press and hold the handheld transmitter button you want to program while watching the indicator on HomeLink. Continue to hold the handheld button until the HomeLink indicator flashes rapidly or is continuously on.

**Note:** You may need to use a different method if you live in Canada or have difficulties programming your gate operator or garage door opener.

5. Press and hold the HomeLink button you programmed for two seconds, then release. You may need to do this twice to activate the door.

**Note:** If the indicator stays on, the programming is complete.

**Note:** If the HomeLink indicator flashes rapidly, repeat Step 5.

**Note:** If your device still does not operate, you must program your garage door.

6. To program additional buttons, repeat Steps 1–4.

### Programming the Garage Door Opener to your Garage Door Opener Motor



1. Press the learn button on the garage door opener motor and then you have 30 seconds to complete the next two steps.
2. Return to your vehicle.

## Garage Door Opener (If Equipped)

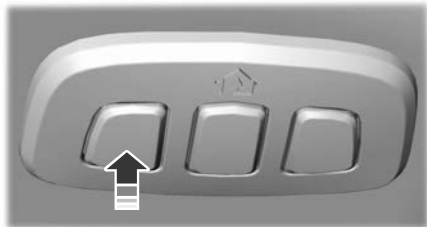

3. Press and hold one of the three HomeLink function buttons you want to program for two seconds, then release.
4. Repeat Step 3. Depending on your brand of garage door opener, you may need to repeat this sequence a third time.

Additional assistance can be found online at [www.homelink.com/Ford](http://www.homelink.com/Ford) or by calling the toll-free help line at 1-800-355-3515.

### Programming the Garage Door Opener to your Gate Opener Motor

#### Gate Operator / Canadian Programming

Canadian radio-frequency laws require transmitter signals to time-out (or quit) after several seconds of transmission – which may not be long enough for HomeLink to pick up the signal during programming. Similar to this Canadian law, some U.S. gate operators are designed to time-out in the same manner.

**Note:** *If programming a garage door opener or gate operator, it is advised that you unplug the device during the **cycling** process to prevent possible overheating.*

1. Press and release your handheld transmitter, **every two seconds**, until the HomeLink indicator flashes rapidly or is continuously on.

2. Release the handheld transmitter button.
3. Press and hold the HomeLink function button you want to program for two seconds, then release. You may need to do this twice to activate the door.

**Note:** *If the indicator stays on, the programming is complete.*

**Note:** *If the HomeLink indicator flashes rapidly, repeat Step 3.*

4. To program additional buttons, repeat Steps 1–4.

Additional assistance can be found online at [www.homelink.com/Ford](http://www.homelink.com/Ford) or by calling the toll-free help line at 1-800-355-3515.

## GARAGE DOOR OPENER ADDITIONAL ASSISTANCE

### Video Setup Instructions

Additional assistance can be found online at [www.homelink.com/Ford](http://www.homelink.com/Ford) or by calling the toll-free help line at 1-800-355-3515.



# USB Ports

## LOCATING THE USB PORTS

### Data Transfer USB Ports



The USB ports could be in the following locations:

- On the lower instrument panel.
- Inside the center console.

**Note:** *These USB ports can also charge devices.*

**Note:** *Not all USB ports in your vehicle have data transfer capabilities.*

**Note:** *We recommend using only USB-IF certified cables and adapters. Non-certified cables and adapters may not work.*

### Charge Only USB Ports



The USB ports could be in the following locations:

- On the lower instrument panel.
- On the upper instrument panel.
- Inside the media bin.
- Inside the center console.
- On the rear of the center console.
- In the cargo area.
- In the frunk.

## PLAYING MEDIA USING THE USB PORT - VEHICLES WITH: 12.3 INCH SCREEN



**WARNING:** Driving while distracted can result in loss of vehicle control, crash and injury. We strongly recommend that you use extreme caution when using any device that may take your focus off the road. Your primary responsibility is the safe operation of your vehicle. We recommend against the use of any hand-held device while driving and encourage the use of voice-operated systems when possible. Make sure you are aware of all applicable local laws that may affect the use of electronic devices while driving.

Connect your device to the USB port.



Press the audio button on the feature bar.

Select **Sources**.



Select the USB option.



Press to play a track. Press again to pause the track.



Press to skip to the next track.

Press and hold to fast forward through the track.



Press once to return to the beginning of a track. Repeatedly press to return to previous

tracks.

Press and hold to fast rewind.

# USB Ports

## PLAYING MEDIA USING THE USB PORT - VEHICLES WITH: 15 INCH SCREEN



**WARNING:** Driving while distracted can result in loss of vehicle control, crash and injury. We strongly recommend that you use extreme caution when using any device that may take your focus off the road. Your primary responsibility is the safe operation of your vehicle. We recommend against the use of any hand-held device while driving and encourage the use of voice-operated systems when possible. Make sure you are aware of all applicable local laws that may affect the use of electronic devices while driving.

Connect your device to the USB port.



Press the button on the status bar to open the application drawer.



Press the USB option.



Press the button to play a track. Press the button again to pause the track.



Press the button to skip to the next track.

Press and hold the button to fast forward through the track.



Press the button once to return to the beginning of a track. Repeatedly press the button to return to previous tracks.

Press and hold the button to fast rewind.

## CHARGING A DEVICE

Connect your device to the USB port.

### Data Transfer USB Ports



You can charge your device through the data transfer USB port when SYNC is on.

### Charge Only USB Ports



You can charge your device through the charge only USB port when the vehicle is in accessory mode or when the vehicle is running.

# Power Outlet

---

## WHAT IS THE POWER OUTLET

The power outlet can power devices using a 12 V outlet adapter.

## POWER OUTLET PRECAUTIONS



**WARNING:** Do not plug optional electrical accessories into the cigar lighter socket. Incorrect use of the cigar lighter can cause damage not covered by the vehicle warranty, and can result in fire or serious injury.

When you switch the vehicle on, you can use the socket to power 12 V appliances with a maximum current rating of 20 A. Do not use the power point over the vehicle capacity of 12 V DC 240 W or a fuse could blow. Do not plug in any device that supplies power to the vehicle through the power points. This could result in damage to vehicle systems. Do not hang any accessory from the accessory plug. Always keep the power point caps closed when not in use. Do not insert objects other than an accessory plug into the power point.

To prevent the battery from running out of charge:

- Do not use the power point longer than necessary when the vehicle is off.
- Do not leave devices plugged in overnight or when you park your vehicle for extended periods.

## LOCATING THE POWER OUTLETS

Power outlets are in the following locations:

- On the instrument panel.
- Inside the center console.
- On the rear of the center console.

# Onboard Generator

## WHAT IS THE ONBOARD GENERATOR

The vehicle functions as a portable generator and can power devices that require up to the rating listed on the power outlet label.

## ONBOARD GENERATOR PRECAUTIONS



**WARNING:** Do not connect any vehicle power outlets to any premises. This can create a backfeed to utility lines. Failure to follow this instruction could result in property damage, fire, electrical shock or death.



**WARNING:** Do not keep electrical devices plugged in the power point whenever the device is not in use. Power points power up during remote start.



**WARNING:** Do not use the onboard generator to power a towable item when your vehicle is in motion unless you are using Ford approved accessories.

When you switch the power outlets on, the vehicle power down timer is disabled and the vehicle continues to be powered on.

**Note:** We recommend using UL approved devices for use with the power outlet.

**Note:** Make sure that plugged in devices do not exceed the ratings displayed on the outlet covers.

**Note:** Unplug electrical devices from the power outlet when they are not switched on.

**Note:** Make sure there is no damage to the outlets before driving your vehicle.

**Note:** Power could be limited during extreme hot or cold temperatures to optimize the performance of the system.

**Note:** When the hood is closed, the frunk outlet power is limited.

**Note:** Do not aim a water hose, power washer or high-powered spray nozzle directly at the power outlet cover when cleaning the frunk.

**Note:** Close all outlet covers when not in use.

## Grounding Type

### Neutral Bonded

The neutral of the inverter generator is bonded to system ground. Connecting loads that also have neutral bonded to ground causes the ground fault detection to trip.

**Note:** If additional grounding measures are required, consult with a qualified electrician.

## LOCATING THE OUTLETS

The power outlets are in the cabin, bed, and frunk of the vehicle.

### Bed Outlet

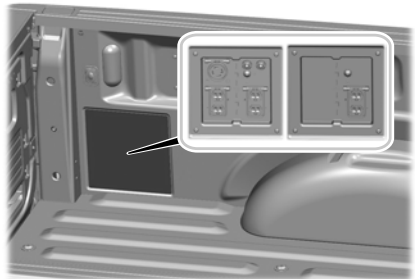

# Onboard Generator

## Frunk Outlet

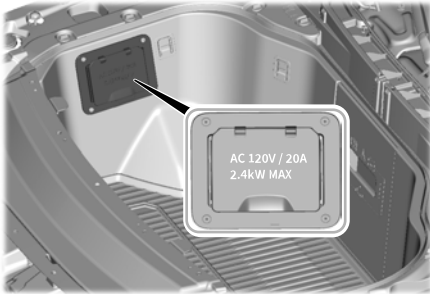

## Instrument Panel Outlet



## Rear Center Console Outlet



## ONBOARD GENERATOR INDICATORS

### Power Outlet Status Indicator

The power outlet indicator illuminates to let you know the status of the system.

Indicator Status	Description
On	The power point is working and the vehicle is on.
Off	The power point is off and the vehicle is off.
Flashing	The power point is in fault mode.

### Fault Mode

The power outlet temporarily turns off power if the device exceeds the watt limit.

1. Unplug your device.
2. Switch your vehicle off to let the system cool and reset the fault mode.

# Onboard Generator

3. Switch your vehicle back on, but do not plug your device back in.
4. With your vehicle on, make sure the indicator light remains on.
5. Make sure your device does not exceed the power limits and then plug in your device.

**Note:** *If a fault occurs again, your device may exceed the capacity available from the power outlet.*

## Power Mode Indicator

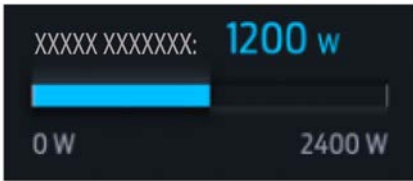

The power mode indicator on the touchscreen displays the power currently being used and the total amount of power available. When you switch the power outlets off, the indicator displays a reduced available power level. When you switch the power outlets on, the indicator displays the full available power.

**Note:** *Additional indicators may be available based on vehicle configuration.*

**Note:** *Make sure that plugged in devices do not exceed the available power displayed on the power mode indicator.*

## SWITCHING THE OUTLETS ON AND OFF - VEHICLES WITH: 12.3 INCH SCREEN

**Note:** *Using the power outlets while the vehicle is charging could increase the vehicle charging time.*

## Using the Center Display Screen

1. Switch the vehicle on.
2. Press **Features** on the touchscreen.
3. Press **Pro Power Onboard**.

## Using the Bed or Frunk Controls



Press the button to switch the power outlet on and off.

## SWITCHING THE OUTLETS ON AND OFF - VEHICLES WITH: 15 INCH SCREEN

**Note:** *Using the power outlets while the vehicle is charging could increase the vehicle charging time.*

## Using the Center Display Screen

1. Switch the vehicle on.
2. Access the feature drawer on the touchscreen.
3. Press **CONTROLS**.
4. Press **Pro Power Onboard**.
5. Press the generator mode button to switch the power outlet to the full rating listed on the power outlet label.

# Onboard Generator

## Using the Bed or Frunk Controls



Press the button to switch the power outlet on and off.

## SETTING THE HIGH VOLTAGE BATTERY RESERVE LIMIT

When the vehicle is in park (P) you can set a high voltage battery reserve limit to save a range which you can drive your vehicle before recharging.

You can set the high voltage battery reserve limit on the touchscreen.

A notification indicates when the vehicle reaches the pre-set limit and **Pro Power Onboard** turns off.

**Note:** After your vehicle reaches the pre-set limit, the vehicle power down timer is enabled again. See **What Is the Vehicle Power Down Timer** (page 195).

## RESETTING GROUND FAULT DETECTION

After disconnecting all electrical loads the ground fault can be reset using the switches on the power point, on the instrument panel or on the touchscreen.

Use the controls on the touchscreen to test the ground fault detection circuit.

## RESETTING THE CIRCUIT BREAKER - VEHICLES WITH: 9.6KW



Press the button on the upper right area of the bed outlet when the circuit breaker has opened after a fault has occurred to reset the circuit breaker to the on position. There are two circuit breaker buttons that correspond to the A and B outlets.

# Onboard Generator

## ONBOARD GENERATOR – TROUBLESHOOTING

### ONBOARD GENERATOR – INFORMATION MESSAGES

Message	Description
Item(s) plugged in exceeded the system's maximum capacity. Try unplugging one or more items and reset. See owner's manual for details.	Make sure that plugged in devices do not exceed the available power displayed. Devices could exceed the power rating shown the device label when plugged in. Unplug the device and switch the vehicle on and off to reset the system.
Generator system is outside its operating temperature and capability is reduced. See owner's manual for details.	Power could be limited during extreme hot or cold temperatures to optimize the performance of the system.
Another power source is trying to supply power to your vehicle's AC outlets. Disconnect vehicle from that power source. See owner's manual for details.	Do not plug in any device that supplies power to the vehicle through the power outlets. This could result in damage to vehicle systems.
This button tests outlets for proper operation of ground fault detection. In a successful test, Pro Power Onboard detects the ground fault and turns off. See owner's manual for details.	The power outlet is in fault mode. Make sure that all devices are unplugged from the system. Use the controls on the touchscreen to reset the system. Switch your vehicle on and off if the touchscreen controls are unable to reset the system. See an authorized dealer if these steps do not fix the fault.



# Onboard Generator

---

## ONBOARD GENERATOR – FREQUENTLY ASKED QUESTIONS

### **Why is there a warning about something being plugged into the bed power outlet when I do not have anything plugged in?**

- One or more of the bed power outlet covers could be ajar or broken. Make sure the generator is off and check the outlet covers. Select OK on the instrument cluster display to acknowledge the warning.

### **Why can I not shift my vehicle out of park (P)?**

- Make sure the bed power outlet covers are closed and not damaged. Press OK on the instrument cluster display to acknowledge the warning to be able to shift out of park (P).

### **What do I do when my instrument cluster display is malfunctioning and I cannot acknowledge the warning to put the vehicle in drive (D).**

- Power the vehicle off and make sure nothing is plugged into the bed power outlets and all outlet covers are closed. Start the vehicle and select OK on the instrument cluster display to acknowledge the warning. Have your vehicle serviced soon.

### **Why do I get a ground fault detection after I wash out the frunk?**

- If the front power outlet gets wet, a ground fault could occur. See **Resetting Ground Fault Detection** (page 187).

### **Can I use the 240 V onboard generator to charge an electric vehicle?**

- It is possible to charge an electric vehicle, however, it requires additional components that are not provided with your vehicle. For additional information, contact an authorized dealer.

### **How can I extend the amount of time the generator can run before the battery runs out?**

- Lowering the battery reserve limit and decreasing the amount of energy your vehicle is using by switching off other electronic features and systems such as the climate control or lighting may extend the amount of time the generator can run.

## Center Console Work Surface (If Equipped)

### USING THE CENTER CONSOLE WORK SURFACE

To use the center console work surface, stow the selector lever. See **Stowing the Selector Lever** (page 229).

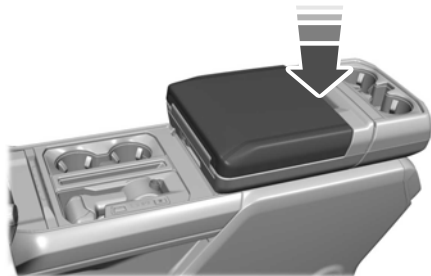

1. Press the button to release the folding surface.

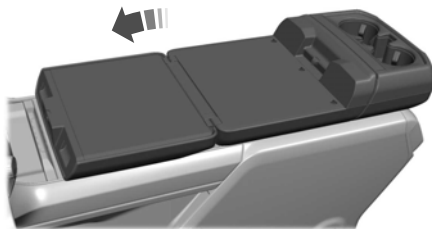

2. Open the work surface. Fold the work surface to close.

### CENTER CONSOLE WORK SURFACE – TROUBLESHOOTING

#### CENTER CONSOLE WORK SURFACE – INFORMATION MESSAGES

Message	Action
Stow work surface before driving.	Return the work surface to the home position to clear the message.

## Wireless Accessory Charger (If Equipped)

### WHAT IS THE WIRELESS ACCESSORY CHARGER

The wireless accessory charger allows you to charge one compatible Qi wireless charging device on the charging area.

### WIRELESS ACCESSORY CHARGER PRECAUTIONS



**WARNING:** Wireless charging devices can affect the operation of implanted medical devices, including cardiac pacemakers. If you have any implanted medical devices, we recommend that you consult with your physician.

Keep the charging area clean and remove foreign objects prior to charging a device.

Do not place items with a magnetic strip or radio-frequency identification chip, for example passports, parking tickets, transportation passes or credit cards, near the charging area when charging a device. Damage could occur to the magnetic strip or radio-frequency identification chip.

Do not place metal objects, for example remote controls, coins and candy wrappers, on or near the charging area when charging a device. Metal objects may heat up and degrade the charging performance, in addition to causing interruptions in charging.

Charging could be interrupted, degraded, or could stop if any of the following occur:

- The system detects a foreign object.
- The device is misaligned on the charging area.
- The device moves on the active charging area when the vehicle is in motion.

- The vehicle ambient temperature is too high.
- You attempt to charge a non-Qi compatible device on the wireless charger.

**Note:** *During charging, the device and the charger could heat up, this is normal. If the battery gets hotter than usual, the device may stop charging.*

### LOCATING THE WIRELESS ACCESSORY CHARGER



The charging area is on the center console or in the media bin below the instrument panel.

### CHARGING A WIRELESS DEVICE

Place the device on the center of the charging surface with the charging side down. The charging stops after your device reaches a full charge.

You can use the charger when the vehicle is in accessory mode, when the vehicle is running, or when SYNC is on.



Displays on the status bar when wireless charging is in progress.

**Note:** *The charging performance may be affected if your device is in a case. It may be necessary to remove the case to wirelessly charge your device.*

**Note:** *Software and firmware updates may affect device compatibility, including the use of unofficial software or firmware. You should verify charging functionality with your specific devices in-vehicle.*

# Storage

## CUP HOLDERS

### CUP HOLDER PRECAUTIONS



**WARNING:** Use caution when stowing items or hot drinks in the cup holders. Items could become loose or spill during hard braking, acceleration or crashes. Failure to follow this instruction could result in personal injury.

## GLOVE COMPARTMENT

### OPENING THE GLOVE COMPARTMENT

#### Upper Glove Compartment

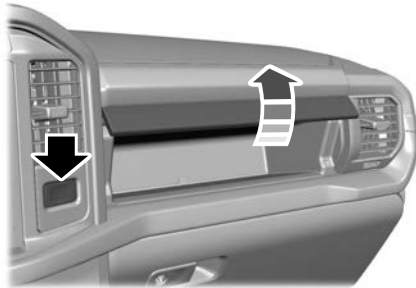

Push the button on the instrument panel to open.

#### Upper Glove Compartment (If Equipped)

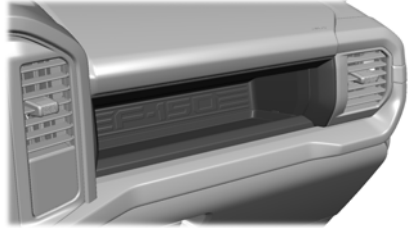

The glove compartment is on the instrument panel.

#### Lower Glove Compartment



Pull the latch to the left to open.

### LOCKING THE GLOVE COMPARTMENT

You can lock lower glove compartment using the key.

# Storage

---

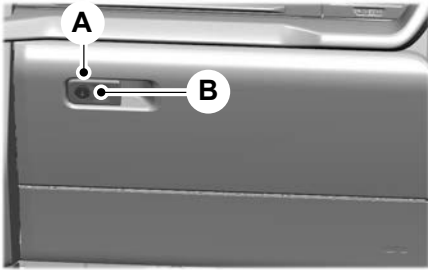

A Unlock.

B Lock.

## GLASSES HOLDER

### LOCATING THE GLASSES HOLDER



The glasses holder is in the overhead console.

Press near the rear edge of the door to open it.

# Starting and Powering Off

## STARTING AND POWERING OFF PRECAUTIONS

- The system may not function if the remote control is close to metal objects or electronic devices, such as keys or a cell phone.
- A valid remote control must be inside your vehicle to switch the power on and start your vehicle.
- Remote controls left inside your vehicle when locked are disabled. A message may appear in the information display indicating that there is no key detected when you try to start your vehicle. Press the unlock button on the remote control to enable it, and then start your vehicle.
- Make sure all occupants fasten their seat belt.
- Make sure the headlamps and electrical accessories are off.
- Make sure the parking brake is on.
- Make sure the vehicle is in park (P).

## STARTING THE VEHICLE

1. Fully press the brake pedal.

**Note:** Do not touch the accelerator pedal.



2. Press the push button start.

You can also start your vehicle using Valet Mode or a Backup Start Passcode. See **Phone as a Key** (page 72).

## POWERING OFF



**WARNING:** Do not switch off your vehicle when it is moving. This results in a significant decrease in braking and steering assistance. If the vehicle is switched off, some electrical circuits, for example airbags, could also turn off. Failure to follow this instruction could result in the loss of control of your vehicle, personal injury or death.

**Note:** If you unintentionally switch your vehicle off, shift into neutral (N) and restart your vehicle.

When your vehicle is not moving and is started, or the power is in accessory mode, press and release the push button start without pressing the brake pedal. This shuts off the vehicle and all electrical accessories.

When your vehicle is moving, press the push button start three times within two seconds, or press and hold for at least one second. Shift into neutral (N) and use the brakes to bring your vehicle to a safe stop. When your vehicle comes to a complete stop, shift into park (P).

## RESTARTING THE VEHICLE AFTER POWERING OFF

### Fast Restart

The fast restart feature allows you to restart your vehicle within 10 seconds of switching it off, even if it does not detect a valid remote control.

# Starting and Powering Off

Within 10 seconds of switching your vehicle off, press the brake pedal and press the push button start. After 10 seconds, you can no longer start your vehicle if it does not detect a valid remote control.

Once your vehicle starts, it remains on until you press the push button start, even if it does not detect a valid remote control.

If you open and close a door while your vehicle is on, the system searches for a valid remote control. You cannot start your vehicle if the system does not detect a valid remote control within 10 seconds.

## VEHICLE POWER DOWN TIMER

### WHAT IS THE VEHICLE POWER DOWN TIMER

Vehicle power down timer automatically shuts down your vehicle if it has been powered on and stationary for an extended period of time.

### HOW DOES THE VEHICLE POWER DOWN TIMER WORK

Before your vehicle shuts down, a message appears in the information display showing a timer counting down from 30 seconds. If you do not intervene within 30 seconds, your vehicle shuts down.

After the shutdown, another message appears in the information display to inform you that your vehicle has shut down in order to save battery energy.

Start your vehicle as normal.

### SWITCHING THE VEHICLE POWER DOWN TIMER ON AND OFF

1. Press **Settings** on the touchscreen.
2. Press **Vehicle Settings**.
3. Switch **30min Max Idle** on or off.

**Note:** You cannot permanently switch off the vehicle power down timer. If you switch it off, it turns on each time you switch the vehicle on.

## OVERRIDING THE VEHICLE POWER DOWN TIMER

You can stop the shutdown or reset the timer before the 30-second countdown has expired by doing any of the following:

- Pressing the brake or accelerator pedal.
- Pressing the **OK** or **RESET** button during the 30-second countdown.

## ACCESSING THE PASSIVE KEY BACKUP POSITION

If you are unable to start your vehicle, locate the backup slot in the following position.

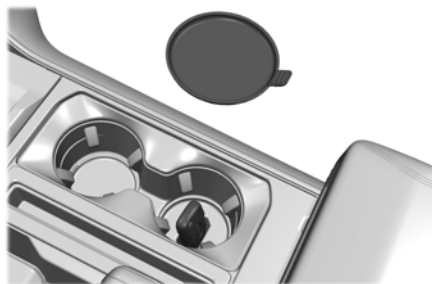

**Note:** Make sure to place the key properly into the backup slot.

With the key in the backup slot, press the brake pedal, then press the push button ignition switch to start your vehicle.

# Starting and Powering Off

---

## STARTING AND POWERING OFF – TROUBLESHOOTING

### STARTING AND POWERING OFF – FREQUENTLY ASKED QUESTIONS

#### Why does the vehicle not start?

The system does not function if the remote control frequencies are jammed, or if the remote control battery has no charge. See **Accessing the Passive Key Backup Position** (page 195).



# High Voltage Battery

## WHAT IS THE HIGH VOLTAGE BATTERY

The high voltage battery is a highly sophisticated lithium ion battery system, used to store electrified energy to power the vehicle.

## HIGH VOLTAGE BATTERY PRECAUTIONS



**WARNING:** This battery pack should only be serviced by an authorized electric vehicle technician. Improper handling can result in personal injury or death.

Your vehicle consists of various high-voltage components and wiring. All of the high-voltage power flows through specific wiring assemblies labeled as such or covered with a solid orange convolute, or orange striped tape, or both. Do not come in contact with these components.

## PRESERVING YOUR HIGH VOLTAGE BATTERY

When using the battery at a low state of charge, your vehicle could start disabling accessory features to protect battery life.

If your vehicle reaches a 0% state of charge, recharge your vehicle as soon as possible.

In everyday use it is acceptable to use the full state of charge window, however there are a few best practices we recommend in order to maintain the health and life of your battery.

## Overnight Charging

You can increase the longevity and performance of your high voltage battery by using the charge scheduling and departure and comfort settings on your touchscreen or in the FordPass app.

With Charge Scheduling, you can improve the high voltage battery's longevity by delaying the start of charging and setting a maximum charging limit. We recommend you set your preferred charging times to be at least 2-3 hours after your typical plug in time. This allows the battery to cool before charging begins. Additionally, setting the maximum charge level to be less than 100% for everyday usage reduces strain on the battery.

You can improve driving range and performance by scheduling departure times and cabin comfort level with the Departure and Comfort feature. This not only warms or cools the cabin but also conditions the battery to ensure the best driving range and performance by the set departure time.

## DC Charging

Frequent use of DC charging could result in reducing your battery's efficiency and lifespan. This is more pronounced on the standard range battery pack versus the extended range battery pack. See **What is DC Charging** (page 199).

## Storage Temperature

Storing your vehicle in temperatures between 32°F (0°C) and 113°F (45°C) is the most beneficial range for the high voltage battery.

At temperatures just above the freezing point or lower, plug in your vehicle to maintain battery performance and maximize driving range.

# High Voltage Battery

---

## Storage State of Charge

You can increase the battery life by maintaining your state of charge below 100%. When you park your vehicle for an extended period of 30 days or more, we recommend your battery be at an approximately 50% state of charge. Storing your vehicle's high voltage battery at higher states of charge is less favorable than storing at lower states of charge.

**Note:** *To achieve this state of charge for storage, you can drive your vehicle down to 50% and set a charge limit for your location. See **Setting the Charging Schedule and Preferences** (page 214).*

## RECYCLING AND DISPOSING OF THE HIGH VOLTAGE BATTERY

Please recycle in accordance with local regulations.

## HIGH VOLTAGE BATTERY – TROUBLESHOOTING

### HIGH VOLTAGE BATTERY – WARNING LAMPS



Illuminates when the powertrain requires service. Have the system checked as soon as possible.

# Charging Your Vehicle

## WHAT IS AC CHARGING

AC charging is the preferred method of charging. AC charging preserves the health of the high voltage battery for longer high voltage battery life.

## WHAT IS DC CHARGING

DC charging allows you to charge the vehicle's high voltage battery in significantly less time than the standard charge method. You can charge on the go before the battery has exhausted all of its power, or when traveling using the trip planner as part of your FordPass App.

For the convenience of DC charging and time, there is a different fee structure depending on the charging station and network you choose.

**Note:** *Charge times vary depending on outside air temperature, power level, charger type, and location in which you are charging.*

**Note:** *The system could reduce the DC charging rate to maximize the life of the battery.*

## CHARGING YOUR VEHICLE PRECAUTIONS



**WARNING:** Do not allow charging equipment to be immersed in water or liquids. Failure to follow this warning could result in fire, serious personal injury or death.



**WARNING:** Do not attempt to open the charging equipment. Failure to follow this instruction could result in personal injury, death or property damage.



**WARNING:** Do not use the charging equipment if it is faulty or has been damaged. Failure to follow this instruction could result in personal injury, death or property damage.



**WARNING:** Install charging equipment in compliance with local regulations. Failure to follow this warning could result in fire, serious personal injury or death.

## CHARGING EQUIPMENT



**WARNING:** Do not use an ungrounded wall outlet. The wall outlet must be in good condition and meet up-to-date local codes. Have a qualified electrician check the wall outlet, if you suspect that it is not properly grounded. Failure to follow this instruction could result in electric shock, personal injury, or death.



**WARNING:** It is recommended that electrical outlets for use with your charging equipment be installed by a licensed, qualified electrician. Installations must comply with the provisions of all local codes. Failure to follow this warning could result in personal injury or death.



**WARNING:** Do NOT DROP the control box or coupler.



**WARNING:** Do NOT use if stored outside temperature range specified.





**WARNING:** Do not attempt to repair the charging equipment. Contact your local dealer for assistance.

# Charging Your Vehicle

 **WARNING:** Read all warnings on the charging equipment before using for the first time.

 **WARNING:** Read all instructions in this publication before using the charging equipment.

 **WARNING:** To reduce the risk of fire, connect only to a circuit provided with 50 Amps maximum branch circuit overcurrent protection installed in accordance with NEC and local electrical code.

 **WARNING:** Do not use the charging equipment with an extension cord, surge protector, timer or other adapter. Failure to follow this instruction could result in electric shock or fire.

 **WARNING:** The wall plug must fit firmly into the outlet. If the connection feels loose, worn or the outlet is damaged, have a qualified electrician replace the outlet. Using charging equipment with a worn outlet may cause burns, property damage and increase the risk of electric shock.

 **WARNING:** Fully insert the plug into the wall outlet. Failure to follow this instruction could result in electric shock.

 **WARNING:** Children should be supervised when in the vicinity of the charging equipment while plugged in.

 **WARNING:** Do not put fingers into the electric charge coupler. Failure to follow this instruction could result in electric shock.

 **WARNING:** This equipment has arcing or sparking parts. Do not expose to flammable vapors. Position this equipment at least 18 in (450 mm) above the floor.

 **WARNING:** Do not connect or disconnect any pluggable components of the charging equipment when in use or charging. Failure to follow this instruction could cause damage to the charging equipment.

 **WARNING:** Do not use the charging equipment in temperatures outside of the operation range of -22°F (-30°C) to 122°F (50°C).

 **WARNING:** Store the charging equipment in a clean dry place between the temperatures of -22°F (-30°C) to 185°F (85°C).

 **WARNING:** Do not plug the charging equipment into an electrical outlet that is submerged in water or covered in snow.

 **WARNING:** Do not use charging equipment in severe rain, snow or electrical storm.

 **WARNING:** Do not allow charging equipment to be immersed in water or liquids. Failure to follow this warning could result in fire, electric shock, or serious personal injury or death.

 **WARNING:** When using the charging equipment avoid moisture, water, snow and foreign objects at all times.

# Charging Your Vehicle

**WARNING:** Do not replace the plug on the connector. There are critical safety devices in the plug, and the charging equipment will not operate, if the plug is replaced. Failure to follow this instruction could result in electric shock, personal injury, death, or fire.

**WARNING:** Charging equipment contains no user modifiable or repairable parts. If the charging equipment plug does not properly fit into the wall outlet, have a qualified electrician install the correct wall outlet. Failure to follow this instruction could result in personal injury or death.

**WARNING:** High voltage is present in your electric meter housing and power distribution service panel. Contact with high voltage can cause death or serious personal injury.

**WARNING:** Visually inspect the charging equipment before each use. Do not use the charging equipment if it is damaged.

**WARNING:** Keep charging equipment inside when not in use. Stow the control box on the hanger or all the charging equipment in the bag after use to prevent damage to the charging equipment and personal injury.

Your vehicle comes with a mobile power cord that has a low power connector to use with a 120V plug NEMA 5-15 and a high power connector to use with a 240V plug NEMA 14-50.

Specification Type	Specification Value
Charger Model	SAE
Voltage	120-240 VAC
Maximum Current	32 Amps max continuous
Frequency	60Hz
Power draw when idle	< 2 Watts
Cable length	Approximately 20 ft (6.1 m)
Weight	8.6 lb (3.9 kg)
Operating temperature	-22°F (-30°C) to 122°F (50°C)
Storage temperature	-22°F (-30°C) to 185°F (85°C)
CCID Environmental	IP67
Ventilation	Not required

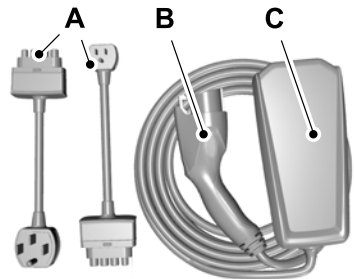

- A Connector.
- B Coupler.
- C Control box.

# Charging Your Vehicle

The mobile power cord is located under the passenger seat and allows you to charge the vehicle's battery using a standard household outlet.

You must plug the connector into the charger control box first. Then plug the connector into the household outlet, and then plug the coupler into the vehicle charge port.

The power indicator illuminates blue when the connector is properly inserted into the charger control box and dedicated wall outlet.

**Note:** To insert the connector, firmly grasp the connector by the cable or plug and push into the charger control box until an audible click is heard. Make sure the connector is fully inserted and flush with the charger control box before inserting it into the outlet. Improper insertion of the connector results in an amber fault light or intermittent charging, and a longer charge session.

**Note:** Follow the installation instructions provided with the mobile power cord.

**Note:** We recommend using the supplied plugs and connectors.

**Note:** If you do not use a dedicated circuit, the circuit breaker could trip or open. If a dedicated circuit is not available, contact a licensed professional electrician regarding the installation of a dedicated outlet.

**Note:** The mobile power cord does not charge and gives a fault indication if ground is not present.

**Note:** Plug the connector for the mobile power cord directly into the wall plug receptacle. Do not plug the mobile power cord into any form of extension cord.

**Note:** The wall bracket must be used to support the charge control box. The charge control box cannot be hung from the outlet or wall plug.

## Mobile Power Cord Indicator Lights

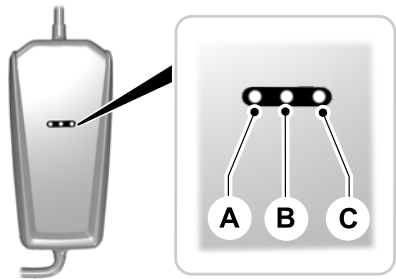

- A Amber fault indicator light.
- B Blue status indicator light.
- C Red trouble indicator light.

# Charging Your Vehicle

---

<b>Mobile Power Cord Fault Indicator Type</b>	<b>Indicator Description</b>
AMBER	The amber fault indicator illuminates to communicate that the charger is rebooting after an error.
BLUE	When plugged into the wall outlet, the blue indicator illuminates to communicate that the charger is ready to use.
RED	The red indicator illuminates when the charger has detected an error. If the red indicator is illuminated, the charger will not deliver power to the vehicle. The error must be corrected before a charging cycle can begin or continue.

**Note:** *When first plugged into a wall outlet the amber, blue and red indicators blink once. Then the blue indicator turns on, followed by a blink of the red indicator. After, the blue indicator turns off then back on. This cycle happens twice if a different connector is used from a previous charge.*

## Charging Your Vehicle

<b>AMBER</b>	<b>BLUE</b>	<b>RED</b>	<b>MODE</b>	<b>ACTION</b>
OFF	OFF	OFF	UNPOWERED; The mobile power cord is not powered.	Make sure the outlet is operational, and the circuit breaker is in the ON position or try using another outlet. Ensure the connector is fully inserted into the mobile power cord. Ensure the plug is not severely degraded. If the error persists, contact us.
OFF	PULSING	OFF	CHARGING; The mobile power cord is charging.	No action required.
OFF	ON	OFF	STANDBY; The mobile power cord is powered and ready to charge. At the current time the mobile power cord is not charging the vehicle.	If you expect the mobile power cord to be charging the vehicle, make sure the vehicle coupler is properly inserted into the vehicle. Check and adjust your charging time preferences in the on-screen display. If your vehicle is still not charging, contact us.
ON	ON	ON	REBOOTING; The mobile power cord is recovering after encountering an error.	Wait for the mobile power cord to return to standby. If the mobile power cord cycles for more than 2-3 minutes, unplug the vehicle coupler. Unplug and replug in the connector. If the issue persists, contact us.
ON	PULSING	OFF	CHARGING REDUCED; The mobile power cord is charging at a reduced rate due to overheating.	Make sure the connector and the control box are properly connected. Unplug and replug in the connector. If the mobile power cord is warm or in a hot environment, try charging in a cooler area. Try a different outlet. Try a different connector if you have one available. If the error persists, contact us.



## Charging Your Vehicle

<b>AMBER</b>	<b>BLUE</b>	<b>RED</b>	<b>MODE</b>	<b>ACTION</b>
1 FLASH	PULSING	OFF	CHARGING REDUCED, AC PLUG OR WALL OUTLET; The mobile power cord is charging at a reduced rate due to overheating of the connector or the wall outlet.	Make sure the connector and control box are properly connected. Unplug and replug in the connector. If the mobile power cord is warm or in a hot environment, try charging in a cooler area. Try a different outlet. Try a different connector if you have one available. If the error persists, contact us.
ON	OFF	OFF	USER TROUBLESHOOTING; The mobile power cord has encountered a fault that requires troubleshooting.	Make sure the connector and control box are properly connected. Unplug and replug in the connector. If the mobile power cord is warm or in a hot environment, try charging in a cooler area. Try a different outlet. Try a different connector if you have one available. If the error persists, contact us.
OFF	OFF	ON	NON - RECOVERABLE FAULT; There is an internal fault in the mobile power cord that cannot be recovered.	Try a different connector if you have one available. If the error persists, contact us.
OFF	OFF	1 FLASH	NON - RECOVERABLE FAULT; There is an internal fault in the connector that cannot be recovered.	Try using another connector if you have one available. If not, contact us about obtaining a replacement. If your warranty has expired, you can order a replacement from your Ford dealer.
OFF	OFF	PULSING	GROUND LEAKAGE FAULT; Electrical current is leaking through a potentially unsafe path.	Potential shock hazard - immedi- ately turn off circuit breaker for the outlet within home. Discontinue use. Contact us about obtaining a replacement.

# Charging Your Vehicle

**Note:** When plugging into an unfamiliar wall outlet, let the vehicle charge for several minutes before leaving it unattended. The red indicator illuminates if not charging. The unit turns off if a breaker or infrastructure ground fault circuit interrupter (GFCI) is tripped. You can view vehicle charging status remotely via the Ford Pass app.

## Mobile Power Cord Auto-Restart

Auto-restart helps to make sure that your vehicle will be charged and ready for use when needed. A charge could be interrupted if errors are detected. Charging resumes once the error is no longer detected. The red indicator illuminates during an error condition.

The exception to the immediate auto-restart is when the interruption is due to a charger ground fault circuit interrupter (GFCI) event. The charger attempts to restart 15 minutes after a ground fault circuit interrupter (GFCI) event. After the fourth attempt to restart, the charger shuts down and the red indicator stays on.

If the fault persists, do not continue to try to charge your vehicle. Contact your authorized dealer.

## MOVING AND STORAGE INSTRUCTIONS

Make sure you wrap the mobile power cord after charging. Store the mobile power cord in the storage bag supplied with the mobile power cord.

When charging is complete, replace the mobile power cord under the passenger seat.

**Note:** Do not hold the mobile power cord by the power cable. Hold the complete unit and carefully place back in the storage bag.

**Note:** To remove the connector, firmly grasp the connector by the cable or plug and pull away from the control box.

## CARE INSTRUCTIONS

Do not use cleaners or solvents as this could damage your mobile power cord. Do not place stress on the charger cables. If unit overheats, remove the mobile power cord from direct sunlight.

## SAFETY FEATURES

The charger includes the following safety features to protect against the risk of electric shock:

- **Service Ground Check:** The charger constantly checks for the presence of a service ground connection. If the service ground ever fails, the charger red indicator turns ON and shuts down power to the vehicle.
- **Thermal Event Sensor:** Charger module senses out-of-ordinary thermal events and decreases the charging current or shuts the unit down if required.
- **Ground fault circuit interrupter (GFCI) Protection:** The charger has a ground fault circuit interrupter (GFCI) reaction system to protect against electric shock. If the charger module detects an output ground fault, it shuts down power to the output cable and illuminates the red indicator.
- **Insulation:** The charger module, connector, cable assembly, and charge coupler are completely insulated. There are no exposed live parts, to protect against electric shock.
- **Unintentional Disconnection:** The charge coupler is designed to minimize unintentional disconnection. A pilot signal wire in the cable and charge coupler eliminates the possibility of electric shock when not connected to a vehicle or if an unintended disconnect occurs during a charge. Disconnection during charging is safe.

# Charging Your Vehicle

## LOCATING THE CHARGE PORT

The charge port is on the left-hand side of the vehicle. Press and release the center right-hand edge of the charge port door to open.



**Note:** Do not apply excessive force. Forcing the door open or closed damages the charge port.

## CHARGE PORT INDICATORS

The charge status indicator is next to the charging port behind the charge port door. It indicates the charge status of the high voltage battery in your vehicle.

Divided into five zones, the charge status indicator displays the state of charge in 20 percent increments.

The charge status indicator displays how far along the charge is.

- When zone A is pulsing, the charge is between 0-20 percent.
- When zone A illuminates, and zone B is pulsing, the charge is between 20-40 percent.
- When zones A and B illuminate and zone C is pulsing, the charge is between 40-60 percent.

- When zones A, B and C illuminate, and zone D is pulsing, the charge is between 60-80 percent.
- When zones A, B, C and D illuminate, and zone E is pulsing, the charge is between 80-100 percent.
- When all zones illuminate, the charge is 100 percent.



**Note:** When charging stops, the charge status indicator illuminates all completed zones in a solid blue for 30 seconds before turning off. For example, if charging stops at 70 percent, then A, B and C illuminate a solid blue to indicate a battery charge level of at least 60 percent but less than 80 percent. Charging stops when complete or when paused due to charge settings or charge station actions.

**Note:** If the charge status indicator does not illuminate or pulse after plugging in, verify that the charge port light setting is on. If you do not wish to have the charge status indicator illuminate at all while charging, you can turn it off. Locate the charge port light under the vehicle settings on your in-vehicle touchscreen.

There are four charge port indicator light colors which indicate a specific action:

White is used as a courtesy light to help with plugging in and to acknowledge actions such as plugging and unplugging.

# Charging Your Vehicle

Blue indicates when the vehicle is plugged in and is either charging or waiting to charge.

Green indicates power transfer using the intelligent backup power system.

Amber indicates charge faults.



**Note:** Charging faults are identified by the color amber on the charge status indicator. Faults can occur within the vehicle charging system or outside the vehicle, such as with the mobile power cord, charge station or electrical supply.

**Note:** If the system detects a fault in the vehicle charging system at any point in a charge cycle, the entire charge status indicator illuminates a solid amber color for 30 seconds and then turns off. If this happens, unplug the charge coupler and plug it back into the charge port receptacle. If the problem persists, have your vehicle serviced as soon as possible.

**Note:** If the system detects a fault outside the vehicle, such as with the charge station or mobile power cord, the entire charge status indicator flashes amber continuously for 30 seconds and then turns off. If this happens check the mobile power cord, charge station or electrical supply.

## AC CHARGING

### CONNECTING THE CHARGER



**WARNING:** Do not use the charging equipment if it is faulty or has been damaged. Failure to follow this instruction could result in personal injury, fire, electric shock, death or property damage.



### Charging Using the Mobile Power Cord

**CAUTION: TO REDUCE THE RISK OF FIRE-** The plug must be properly grounded. Use a dedicated circuit. If you do not use a dedicated circuit, the circuit breaker could trip or open. If you do not have a dedicated circuit, contact a licensed professional electrician for proper installation.

To charge the high voltage battery:

You must unwrap the mobile power cord completely before charging.

1. Put your vehicle in park (P).

**Note:** Your vehicle must be in park (P) to charge.

2. Plug the connector into the charger control box.

**Note:** To insert the connector, firmly grasp the connector by the cable or plug and push into the charger control box until an audible click is heard. Make sure the connector is fully inserted and flush with the charger control box before inserting it into the outlet. Improper insertion will cause a longer charge session or faults.

3. Plug the connector into the wall outlet.
4. Confirm that the mobile power cord indicator lights illuminate.

# Charging Your Vehicle



5. Press and release the center right-hand edge of the charge port door to open.

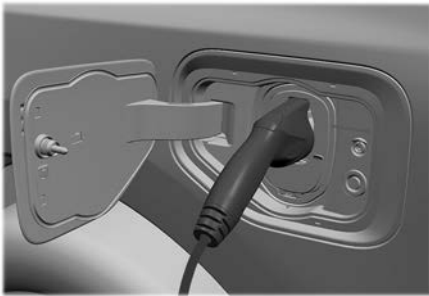

6. Plug the charge coupler into the charge port receptacle on your vehicle.

**Note:** Make sure the button clicks confirming that you have completely engaged the coupler. When you plug in your vehicle, it starts charging to 100% by default unless scheduled charging has been set up for this location. See **Setting the Charging Schedule and Preferences** (page 214).

**Note:** Plug the connector into the wall outlet before connecting the charge coupler handle to your vehicle's charge port.

**Note:** When the handle is properly engaged the light ring illuminates. This indicates the beginning of a normal charge cycle.

**Note:** There could be a delay in light ring illumination due to vehicle internal communications.

**Note:** If charging for your vehicle fails, please contact the Customer Relationship Center, or click on Live chat. To ensure superior service, please take note of your serial number when contacting customer support.

For more information, visit [www.owner.ford.com](http://www.owner.ford.com).

## Charging At a Charge Station

1. Put your vehicle in park (P).

**Note:** Your vehicle must be in park (P) to charge.



2. Press and release the center right-hand edge of the charge port door to open.

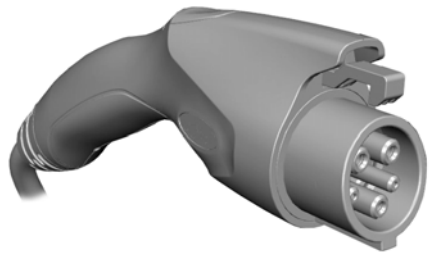

# Charging Your Vehicle

3. Select the appropriate charge station coupler.

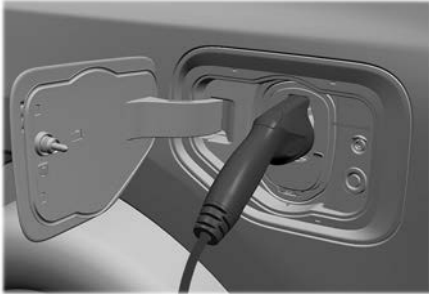

4. Plug the charge coupler handle into the charge port receptacle on your vehicle.

**Note:** Make sure the button clicks confirming that you have completely engaged the coupler. When you plug in your vehicle, it starts charging to 100% by default unless scheduled charging has been set up for this location. See **Setting the Charging Schedule and Preferences** (page 214).

**Note:** When the handle is properly engaged the light ring illuminates. This indicates the beginning of a normal charge cycle.

**Note:** There could be a delay in light ring illumination due to vehicle internal communications.

Information about public charge stations, the pricing, power levels and real time availability can be accessed through the in-vehicle touchscreen or the FordPass app. Rates for charging varies by power level, provider, location, and time of day.

When charging your vehicle at a BlueOval Charging Network station, use the FordPass App to activate and pay for charging. You can also just plug in to activate charging at Plug & Charge capable stations. If the charging station is not in the BlueOval Charging Network, use the directions on the charge station to activate the charger.

For more information, visit [www.owner.ford.com](http://www.owner.ford.com).

## STOPPING CHARGING

### Using the mobile power cord



**WARNING:** To safely discontinue charging at any time, follow the disconnect instructions in stopping charging. Charging will automatically and safely come to a stop. The BLUE STATUS indicator remains ON solid when the coupler is removed.

1. Press the latch on the charge coupler and remove it from the vehicle charge port.
2. Remove the connector plug from the wall outlet.

**Note:** Do not pull the connector plug from the wall outlet or the connector from the mobile power cord control box while your vehicle is charging. Doing so could damage the outlet and the cord.

**Note:** You cannot shift your vehicle out of park (P) until you remove the charge coupler.

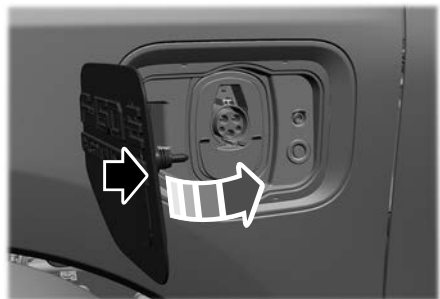

3. Press the center right-hand edge of the charge port door to close.

# Charging Your Vehicle

## Using a charge station

1. Press the latch on the charge coupler and remove it from the vehicle charge port.

**Note:** You cannot shift your vehicle out of park (P) until you remove the charge coupler.

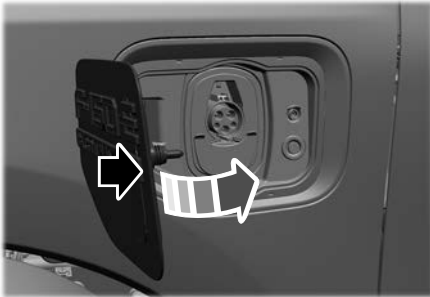

2. Press the center right-hand edge of the charge port door to close.



2. Press and release the center right-hand edge of the charge port door to open the door.



3. Open the additional dust cap on the charge port to expose the lower connectors.

## DC CHARGING

### CONNECTING THE CHARGER



1. Put your vehicle in park (P).

**Note:** Your vehicle must be in park (P) to charge and for the charge status indicator to illuminate.

# Charging Your Vehicle

## STOPPING CHARGING



4. Plug the charge coupler into the charge port receptacle on your vehicle.

**Note:** Make sure the button clicks confirming that you have completely engaged the coupler. Your vehicle locks to the charge coupler.

**Note:** When the handle is properly engaged, the light ring illuminates. This indicates the beginning of a normal charge cycle.

**Note:** The vehicle monitors battery health and may take actions including, but not limited to, reducing the DC fast charge rate to protect the battery hardware from damage, and to maintain battery health.

Information about public charge stations, the pricing, power levels and real time availability can be accessed through the in-vehicle touchscreen or the FordPass app. Rates for charging varies by power level, provider, location and time of day.

**Note:** When charging your vehicle at a public charge station, follow the directions on the charge station.

1. Push the coupler unlock button on the light ring.
2. Press the latch on the charge coupler and remove it from the vehicle charge port.

**Note:** Do not attempt to remove the charge coupler before you unlock it. Do not use any kind of tool to try and remove a locked charge coupler. Doing so can lead to damage to your vehicle and the charge coupler.

**Note:** You can also unlock the cord through the vehicle access menu. If the cord still does not unlock, please contact roadside assistance.

**Note:** You cannot shift your vehicle out of park (P) until you remove the charge coupler.

3. Close the dust cap for the lower connectors.



# Charging Your Vehicle

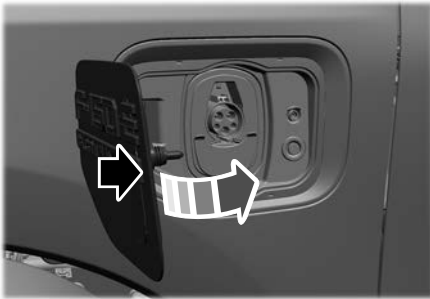

4. Press the center right-hand edge of the charge port door to close.

## Charge Coupler Manual Release

In the event that your vehicle does not unlock the charge coupler, you can manually release it.

1. Switch your vehicle off.
2. Open the hood.
3. Remove the outer luggage compartment covers. See **Installing and Removing the Luggage Compartment Cover** (page 338).

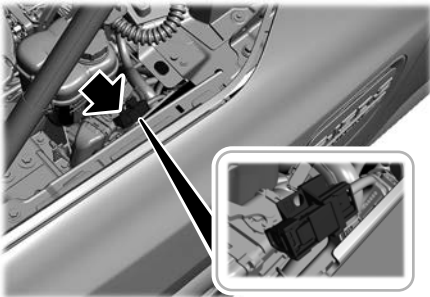

4. Locate the low voltage service disconnect on the left-hand fender apron.

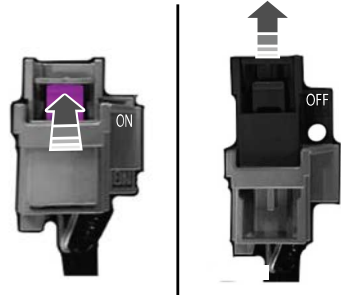

5. Press the latch and pull the low voltage service disconnect to the off position.

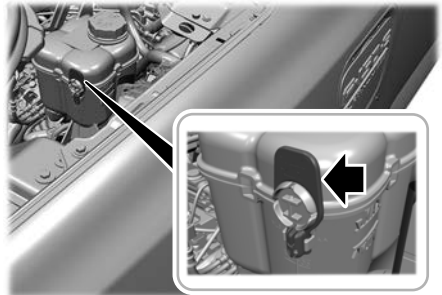

6. Locate the manual release ring.

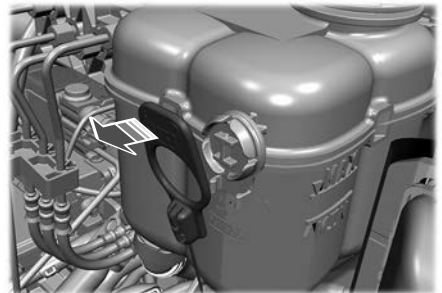

7. Pull the manual release ring upward to detach from grommet.

# Charging Your Vehicle

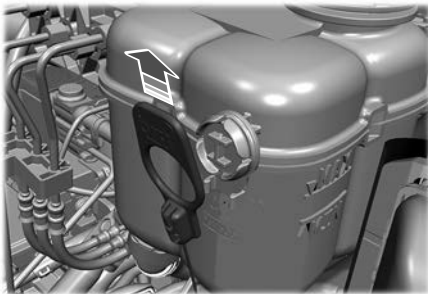

8. Pull the manual release ring firmly in the direction shown.
9. Press the latch on the charge coupler and remove it from the vehicle charge port.
10. Reinstall the manual release ring to the grommet.
11. Push the low voltage service disconnect to on.
12. Reinstall the outer luggage compartment covers.
13. Close the hood.

## SETTING THE CHARGING SCHEDULE AND PREFERENCES



You can schedule charging to take advantage of lower cost electricity rates during off-peak hours if you have signed up for a time of use pricing plan with your utility provider. You can also set a max charge limit for your battery and a departure time and cabin temperature so your vehicle is ready to go when you are.

Scheduled charging can be set up on the touchscreen or in the FordPass app.

To view your charge settings:

1. Press **Features** on the touchscreen.
2. Press Charge Settings on the touchscreen.

### Charge Settings Screen



- A Charging status icon.
- B Charging status.
- C High voltage battery state of charge.
- D Charging time information.
- E One-time max charge limit.
- F Departure and comfort settings.



- A Charging locations.

### Charging Status Icons

Displays when your vehicle is plugged in.



Not charging due to a fault.



Not currently charging.

# Charging Your Vehicle



Charging.



Waiting to charge based on charge time settings.



Transferring power.

## Charging Status

Shows the present state of the charging system.

Charge Status	Action
Will charge when plugged in	The vehicle is unplugged and will start charging once plugged in.
Will wait for preferred charging time	The vehicle is unplugged at a location with charging time preferences enabled. Charging is scheduled to start at the time displayed based on your settings. You must plug in prior to the start time shown for the vehicle to begin charging at that time.
Waiting for preferred charging time	The vehicle is plugged in at a location with charging time preferences enabled. Charging starts at the time displayed, which is based on your charge time settings.
Charging stopped	The vehicle is plugged in and charging has been stopped through the FordPass app.
Charging	The vehicle is plugged in and charging.
Fast charging	The vehicle is plugged into a DC Fast Charge station and charging.
Charged	The vehicle finished charging to the max charge limit setting.
Charging 12V battery	The vehicle is plugged in and charging the 12V battery.
Conditioning the cabin	The vehicle is plugged in and the climate control system is operating according to the departure and comfort settings.
Conditioning the battery	The vehicle is plugged in and conditioning the high voltage battery.
Vehicle charging fault	The vehicle is plugged in and there is a fault within the vehicle charging system. Unplug and plug back in. If the fault is still present, contact your authorized EV certified dealer.

# Charging Your Vehicle

Charge Status	Action
Charge station fault	The vehicle is plugged in and a fault has been detected with the charge station or charging cord. Check the charging cord and the charging station or electrical supply.
Charge station not detected	A charging coupler has been plugged into the vehicle but there is no connection with a charging power source.
Charge station paused	The vehicle is plugged in and charging has been paused at the charge station.
Transferring power	The vehicle is plugged in and power is being transferred using the intelligent backup power system.

## High Voltage Battery State of Charge

Displays the remaining charge percentage with 100% representing the total amount of energy you can get from an external charge.

## Charging Time Information

When charging, the start and estimated end time displays. When fast charging, the end time is replaced with the estimated time at 80% charge until the charge reaches 80%, then the estimated time at 100% charge is displayed.

When your vehicle is at a saved charging location and not plugged in, the start and end times display based on known charging infrastructure.

**Note:** *Charging time information is estimated. Certain conditions could result in longer charging times. See **Charging Your Vehicle** (page 199).*

## One-Time Max Charge Limit

Select to set a one-time max charge limit.

To temporarily adjust the charge level at which charging stops, you can set a one-time max charge limit which will only apply to your next charging session. If the vehicle is already plugged in, the one-time max charge limit will apply to the current charging session. The one-time max charge limit expires after one charging event. The vehicle then reverts to your saved charging location max charge setting or system default if not at a saved charging location.

**Note:** *If connected to a DC fast charger and charging has stopped, you must unplug and plug back in for a new one-time max charge limit to be applied.*

## Departure and Comfort



Press the edit button for departure and comfort settings.

Setting departure times allows you to control charging schedules and warm or cool your cabin and the high voltage battery when your vehicle is plugged in, so your vehicle is ready to drive when you are. By setting a departure time, your vehicle

# Charging Your Vehicle

can use your charging time preferences to minimize your electricity costs but still prioritize finishing charging before your scheduled departure. The calendar view allows you to program two departure times per day for each day of the week.

**Note:** *By using energy from your charging source while plugged in, battery temperature can be managed for best driving performance and less energy is needed for heating or cooling of the cabin at the start of your drive. This helps maximize your driving range.*

**Note:** *You can also access this feature using the FordPass app.*

## Departure and Comfort Setup

Follow these steps to set departure times and cabin comfort level.

1. Press the edit button for departure and comfort on the charge settings screen.
2. Select a time for each day of the week you want your settings to apply. Select the hour and minutes as well as your desired comfort level. Your selected days/times now display your departure and comfort settings. Press Save to apply your settings. The next departure display on the charge settings screen updates appropriately.

**Note:** *Save your departure settings before selecting additional days/times. Repeat the process to add additional unique departure times and comfort levels.*

**Note:** *Cabin conditioning comfort level may vary depending on whether you plug into a normal household outlet or a higher power outlet or charging station. The power available for conditioning is limited to the charging station power available. At low ambient temperatures and low charge power, a small amount of high voltage battery power in addition to the charging power could be used to heat the cabin.*

**Note:** *Departure and comfort settings do not apply when connected to a DC fast charger.*

## Charging Locations



Press the edit button to set preferred charging times for a specific charging location.

Your vehicle prioritizes charging based on your preferred time settings. You can set two preferred charging time windows for weekdays and two for weekends. This feature allows you to take advantage of electric utility rate plans that offer lower pricing during certain times of day. Contact your utility company to see what plans are available.

**Note:** *Your vehicle charges during your preferred time windows. Charging outside these windows only occurs when additional charging time is needed to reach the maximum charge limit set for this location by your next departure time. In this case, the vehicle will typically begin charging right away after plugging in.*

**Note:** *You can also access this feature using the FordPass app.*

## Charging Location Setup

Follow these steps to set time and charge level preferences for a charging location.

**Note:** *Charging location settings do not apply to DC fast chargers.*



Press the edit button for charging locations on the charge settings screen.

1. Select an address from the list of recent charge locations. If the previously saved charge locations are not listed, then you must first select add new location. You can also edit settings for previously saved locations.

# Charging Your Vehicle

**Note:** To save a charging location, the vehicle must have previously charged at that location.

2. Confirm that this is the location you want to save with the help of the map view. Edit the location name if desired and set a maximum charge limit. Press next.

**Note:** Depending on the GPS location, the address on the navigation may not precisely match up with your charging location. Confirm on the map that the pin is in the expected location.

**Note:** Charging stops when your vehicle reaches the maximum charge limit setting.



3. Set preferred charging times for weekday and/or weekend by pressing and dragging along the 24 hour time wheel. You can set up to two blocks of time (charge windows). Press next once you have your desired time settings for weekday and weekend.

**Note:** Selecting all or none of the 24 hours results in any time of day given equal priority for charging.

4. The summary screen displays your settings for this location. Press save or press the left arrow to go back and change your settings. Whenever your vehicle is at a saved charging location, the charge settings screen displays the location name, and the charging times are based on your preferred time settings for that location plus the next departure time.

**Note:** Reaching your max charge limit by your next departure time is always the priority. When charging time preferences are set, charging outside your preferred charging time windows could be necessary to finish by your next departure time. In this case, the vehicle begins charging immediately after plugging in. Charging pauses when the rest of the charge can be done within the preferred charging windows.

Additional information and settings are displayed on the charge settings screen once charging locations and departure and comfort have been set up.

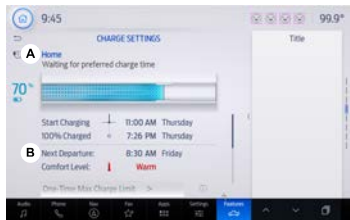

- A Charging location name.
- B Next departure time and cabin temperature.

# Charging Your Vehicle



- A On/Off switch for departure and comfort.
- B On/Off switch for charging locations.

## Charging Location Name

Displays when your vehicle is at a saved charging location.

## Next Departure Time and Cabin Comfort Level

Displays the next departure time and associated cabin comfort setting.

## On/Off Switch for Departure and Comfort

This switch is visible when you have at least one departure time set. Use this switch to turn all departure times off and on. Switching off departure and comfort does not delete your settings, however, you must switch back on to re-enable them.

## On/Off Switch for Charging Locations

This switch is visible when your vehicle is at a saved charging location. Use this switch to turn your settings off and on for this location only. Switching off for this location does not delete your settings, however, you must switch back on to re-enable them.

**Note:** If the charging locations switch is off, the vehicle begins charging to 100% once plugged in.

## USING FORDPASS AND CHARGING

**Note:** FordPass may not be available in some countries or fleet vehicles.

The FordPass app allows you to do the following:

- Monitor and manage your vehicle's charging, including charge schedules and preferences.
- Locate a charger and activate a charger on the BlueOval Charge Network.
- Plan a trip and charging options along your route.
- Check charging station plug availability.
- Initiate a charge session automatically at Plug and Charge capable charge stations.
- Control your Ford Connected Charge Station remotely.
- Override charge preferences and starting and stopping charging.

For more information, visit [www.owner.ford.com](http://www.owner.ford.com).

## CHARGING YOUR VEHICLE HINTS

Use AC charging when possible and minimize the use of DC charging. It helps to preserve your high voltage battery's efficiency and lifespan.

We recommend ending DC charges at 80% state of charge.

**Note:** The system could reduce DC fast charging rate to preserve the battery. This is based on battery temperature, battery state of charge and battery health.

# Charging Your Vehicle

In cold temperatures, you may notice that DC charging takes longer when the outside temperature drops below 50°F (10°C). Shutting off climate control or reducing climate control temperature and fan settings for the first 10 to 15 minutes of DC charging will allow the battery to warm up and improve the charging rate.

**Note:** *When the temperature is below freezing, fully turning off cabin heat for the first 10 to 15 minutes of DC charging could significantly improve the charging rate.*

When AC charging, keep your vehicle plugged in when the outside temperatures are very high or low. This enables the system to maintain the high voltage battery for best performance.

## CHARGING YOUR VEHICLE – TROUBLESHOOTING

### CHARGING YOUR VEHICLE – WARNING LAMPS



Plugged into charger.

## CHARGING YOUR VEHICLE – INFORMATION MESSAGES

Message	Action
Vehicle Plugged In ? Yes No	Your vehicle needs confirmation it is unplugged before allowing a start. You must make sure your vehicle is unplugged and you respond to the message promptly before starting your vehicle.
Plug in to Maintain 12V Battery	Indicates that HV battery can no longer support the 12V battery. Plug In your vehicle to charge the high voltage battery and maintain the 12V battery at a healthy state.
Charge Station Fault See Manual	The vehicle is plugged in and a fault has been detected with the charge station or charging cord. Please check the charging cord and the charging station or electrical supply.



# Charging Your Vehicle

---

## **CHARGING YOUR VEHICLE – FREQUENTLY ASKED QUESTIONS**

### **Why does my vehicle not charge with the mobile power cord?**

Ensure you properly connect the connector and control box. Unplug the charge coupler from the vehicle and unplug the connector from the wall outlet. Then check the connector to be sure that the connector is connected properly into the mobile power cord control box. If the mobile power cord is warm or in a hot environment, try charging in a cooler area. Try a different outlet or a different connector if you have one available. If the problem persists, contact an authorized EV certified dealer.

### **Why does my vehicle have a hum or fan noise when charging?**

A hum or a fan noise could be present when charging the high voltage battery. This is a normal operation as your vehicle is keeping the battery cool while charging.

### **Why does my information display say that the vehicle is charged when it is still pulling power from the charging source?**

In order to keep your battery at the current level, a small amount of power needs to be sourced from the wall to power the vehicle electronics. Once the vehicle is shut down, the vehicle will stop drawing power.

# Intelligent Backup Power

## WHAT IS INTELLIGENT BACKUP POWER

Intelligent backup power allows you to use your vehicle as a backup power source to your home during a power outage.

## HOW DOES INTELLIGENT BACKUP POWER WORK

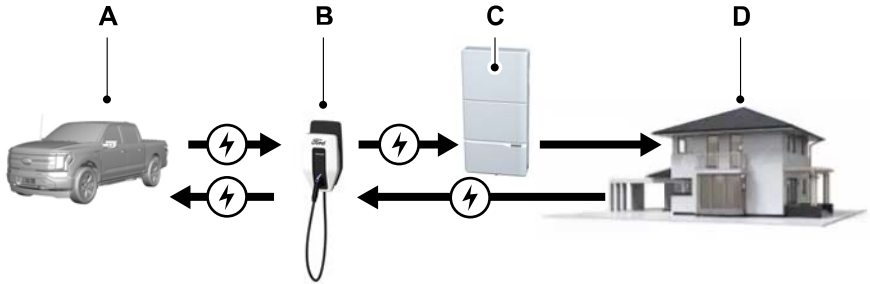

- A Vehicle.
- B Charge station pro.
- C Home integration system.
- D Home.

Intelligent backup power uses a charge station pro and a home integration system that allows your vehicle to transfer power from your vehicle back into your home when plugged in.

## INTELLIGENT BACKUP POWER REQUIREMENTS

The following components must be installed before you can use the system:

- Charge station pro.
- Home integration system.

If you did not receive a charge station pro with your vehicle, you can purchase one by visiting your Ford Owner website.

The home integration system is not included with your vehicle purchase and must be purchased separately.

The system only operates when all of the following occur:

- Your vehicle has been previously paired with the charge station pro.
- Your vehicle is plugged into the charge station pro.
- There is no power to your home.

## PAIRING A CHARGE STATION - VEHICLES WITH: 12.3 INCH SCREEN

To pair your vehicle with a charge station pro:

# Intelligent Backup Power

1. Press **Features** on the touchscreen.
2. Press **Intelligent Backup Power**.
3. Press **Add Station**.
4. Follow the instructions on the center display screen and in the Ford Charge Station Pro Setup app to complete the pairing.

## PAIRING A CHARGE STATION - VEHICLES WITH: 15 INCH SCREEN

To pair your vehicle with a charge station pro:

1. Access the vehicle drawer on the touchscreen.
2. Press **SETTINGS**.
3. Press **Intelligent Backup Power**.
4. Press **Add Station**.
5. Follow the instructions on the center display screen and in the Ford Charge Station Pro Setup app to complete the pairing.

## INTELLIGENT BACKUP POWER SETTINGS - VEHICLES WITH: 12.3 INCH SCREEN

You can use the FordPass app or the center display screen.

### Setting the Power Transfer Mode

1. Press **Features** on the touchscreen.
2. Press **Intelligent Backup Power**.
3. Press the settings icon.
4. Select **Automatic, Manual** or **Off**.

**Note:** When you select off mode, the system does not recognize or notify you of a power outage.

5. Set the energy reserve amount.

**Note:** Set the energy reserve amount so your vehicle retains enough energy to drive within the set range.

**Note:** We recommend setting the energy reserve amount to leave enough charge to reach the nearest available working charging station.

## INTELLIGENT BACKUP POWER SETTINGS - VEHICLES WITH: 15 INCH SCREEN

You can use the FordPass app or the center display screen.

### Setting the Power Transfer Mode

1. Access the vehicle drawer on the touchscreen.
2. Press **SETTINGS**.
3. Press **Intelligent Backup Power**.
4. Select **Automatic, Manual** or **Off**.

**Note:** When you select off mode, the system does not recognize or notify you of a power outage.

5. Set the energy reserve amount.

**Note:** Set the energy reserve amount so your vehicle retains enough energy to drive within the set range.

**Note:** We recommend setting the energy reserve amount to leave enough charge to reach the nearest available working charging station.

# Intelligent Backup Power

---

## TRANSFERRING POWER - VEHICLES WITH: 12.3 INCH SCREEN

### Automatic Mode

When you select automatic mode, the vehicle automatically transfers power to the building in an outage when the vehicle is plugged in. It automatically stops when power returns.

**Note:** You can check the status of the power transfer event in FordPass or in the center display.

**Note:** You can manually stop the power transfer using the FordPass app or center display screen.

### Manual Mode

When you select manual mode, you choose when to start transferring power to the building in an outage.

You can use the FordPass App or the center display screen.

1. Press **Features** on the touchscreen.
2. Press **Intelligent Backup Power**.
3. Press **Start** to transfer power to the building.
4. Press **Stop** to stop transferring power to the building.

## TRANSFERRING POWER - VEHICLES WITH: 15 INCH SCREEN

### Automatic Mode

When you select automatic mode, the vehicle automatically transfers power to the building in an outage when the vehicle is plugged in. It automatically stops when power returns.

**Note:** You can check the status of the power transfer event in FordPass or in the center display.

**Note:** You can manually stop the power transfer using the FordPass app or center display screen.

### Manual Mode

When you select manual mode, you choose when to start transferring power to the building in an outage.

You can use the FordPass App or the center display screen.

1. Make sure your vehicle is plugged in.
2. Access the vehicle drawer on the touchscreen.
3. Press **CONTROLS**.
4. Press **Intelligent Backup Power**.
5. Press **Start** to transfer power to the building.
6. Press **Stop** to stop transferring power to the building.

# Intelligent Backup Power

## INTELLIGENT BACKUP POWER – TROUBLESHOOTING

### INTELLIGENT BACKUP POWER – INFORMATION MESSAGES

Message	Details
Energy Reserve reached. To resume transferring power, in Settings, lower the Energy Reserve setting.	Vehicle state of charge has reached the Intelligent Backup Energy Reserve setting. Intelligent Backup Power stops transferring power.
A vehicle fault occurred. See Owner's Manual for details.	Intelligent Backup Power is in a vehicle faulted state. Try the following: unplug the charge station pro, restart the vehicle, plug the charge station pro back in. If this message remains, see an authorized dealer.
A Ford Charge Station Pro fault occurred. See Owner's Manual for details.	An issue has occurred with the charge station pro. Refer to the charge station pro setup guide for more information.

Message	Details
	If this message remains, see an authorized dealer.
The power is out at a building with a Ford Charge Station Pro paired to your vehicle. To transfer power to a building, plug your vehicle into the station. If your vehicle is not at the building with a power outage, consider charging your vehicle before returning to the building.	To power a building, return to the outage location with the charge station pro. We recommend charging your vehicle up to a sufficient level if your vehicle state of charge is low.

## INTELLIGENT BACKUP POWER – FREQUENTLY ASKED QUESTIONS

### What should I do if I sell my vehicle?

- Perform a master reset to clear previously stored charge stations and settings. See **Performing a Master Reset** (page 555).

### Why is my vehicle not providing power?

- Make sure the settings are set to automatic or manual mode.
- Make sure the vehicle is plugged in properly.
- Check that the charge station pro and home integration system are working properly.

# Intelligent Backup Power

---

## How can I extend the amount of time my vehicle can power my home?

- Lower your energy reserve value and decrease the amount of energy your home uses. The duration in which your house can be powered depends on a variety of factors such as vehicle state of charge and home energy consumption and temperature.

## How long does it take the vehicle to transfer power once power goes out?

- The vehicle begins transferring power within one minute of a power outage event.

## Why does my vehicle look like it is off when it is transferring power?

- The vehicle does not turn on during an intelligent backup power event, however, it is still working as intended. To check the status of power transfer or manually start or stop power transfer in the center display, switch the vehicle on and view the intelligent backup power tile.

## Why is my charge cord locked?

- During an intelligent backup power event, the vehicle locks the charge cord to prohibit unintended removal. In order to remove the charge cord before power has returned, stop the power transfer in FordPass or the center display or press the charge cord unlock button on your charge status indicator by the charging port.

## Why are my controls in FordPass not working on the vehicle?

- If a large scale power outage occurs, it is possible that cellular connectivity may have dropped. In this scenario, starting the system in manual mode, stopping the system, and changing settings must be done through the center display in the vehicle. The vehicle does not communicate with FordPass without cellular connectivity.

## Is there anything I need to do when power comes back on?

- No. When power returns, intelligent backup power recognizes the outage has ended and shuts down appropriately. If your vehicle is plugged in, the system continues normal operation depending on your charge settings.

## Is it normal to hear noises when transferring power?

- Yes. When the vehicle is transferring power, you may hear the vehicle fans turn on. This is normal during system operation.

# Electric Motor

## ELECTRIC MOTOR PRECAUTIONS



**WARNING:** Apply the parking brake, shift into park (P), switch the ignition off and remove the key before you leave your vehicle. Failure to follow this instruction could result in personal injury or death.



**WARNING:** When your vehicle is stationary, keep the brake pedal fully pressed when shifting gears. Failure to follow this instruction could result in personal injury, death or property damage.



**WARNING:** Do not apply the brake pedal and accelerator pedal simultaneously. Applying both pedals simultaneously for more than a few seconds limits vehicle performance, which may result in difficulty maintaining speed in traffic and could lead to serious injury.

## SELECTOR POSITIONS

### PARK (P)



**WARNING:** Shift into park (P) only when your vehicle is stationary.

In park (P) power is not transmitted to the driven wheels.

**Note:** A tone sounds if you attempt to exit your vehicle without the selector lever in park (P).

**Note:** Your vehicle may not shift out of park (P) if the vehicle battery has run out of charge.

**Note:** Your vehicle may not shift out of park (P) if a fuse is blown. See **Fuses** (page 427).

**Note:** Your vehicle may not shift out of park (P) unless the key or remote control is inside your vehicle.

**Note:** Your vehicle could shift into park (P) if you attempt to exit your vehicle without the selector lever in park (P). See **How Does Automatic Return to Park (P) Work** (page 229).

**Note:** If you shift into park (P) without fully pressing the brake, the parking brake could apply. If you shift into park (P) on a slope, the parking brake could apply. See **Automatically Releasing the Electric Parking Brake** (page 239).

**Note:** A tone could sound when you select park (P).

### REVERSE (R)



**WARNING:** Shift into reverse (R) only when your vehicle is stationary.

In reverse (R) power is transmitted to the driven wheels.

### NEUTRAL (N)



**WARNING:** In neutral (N) your vehicle is free to roll.

In neutral (N) power is not transmitted to the driven wheels.

### DRIVE (D)

In drive (D) power is transmitted to the driven wheels.

# Electric Motor

## SHIFTING YOUR VEHICLE INTO GEAR

The selector is in the center console.



1. Press and hold the brake pedal.
2. Press the button on the selector lever and move the lever to select a position.

**Note:** *The position illuminates on the selector.*

3. When you are finished driving, come to a complete stop.
4. Press the button on the selector lever and move the selector lever and securely latch it in park (P).

## TEMPORARY NEUTRAL MODE

### WHAT IS TEMPORARY NEUTRAL MODE

This mode keeps your vehicle in neutral (N) for a limited time when you exit your vehicle or switch your vehicle off.

**Note:** *Do not tow your vehicle in this mode.*

## HOW DOES TEMPORARY NEUTRAL MODE WORK

Use this mode to keep your vehicle in neutral (N) when you exit your vehicle or switch your vehicle off. For example, if you exit your vehicle before an automatic car wash.

**Note:** *You do not need to use this mode at an automatic car wash if you stay in your vehicle with power on.*

**Note:** *Do not tow your vehicle in this mode.*

**Note:** *Automatic return to park (P) is delayed when your vehicle is in this mode. See **What Is Automatic Return to Park (P)** (page 229).*

## TEMPORARY NEUTRAL MODE LIMITATIONS

Your vehicle could shift to park (P) after 30 minutes, or when the vehicle battery charge level is low. Prolonged use of this mode can cause the vehicle's 12V battery to run out of charge.

Do not tow your vehicle in this mode. Failure to follow these instructions could result in vehicle damage not covered by the vehicle warranty.

## ENTERING TEMPORARY NEUTRAL MODE

1. Power your vehicle on.
2. Bring your vehicle to a complete stop.
3. Press and hold the brake pedal.
4. Shift into neutral (N).

**Note:** *An instructional message appears.*

5. Press the neutral hold button twice.



# Electric Motor



**Note:** A confirmation message appears when your vehicle enters temporary neutral mode.

6. Release the brake pedal.

**Note:** Your vehicle is free to roll.

7. Switch your vehicle off.

**Note:** Do not tow your vehicle in this mode.

**Note:** The neutral (N) indicator on the selector may flash while in this mode.

## EXITING TEMPORARY NEUTRAL MODE

1. Press the brake pedal.
2. Shift into park (P), or power your vehicle on and shift into drive (D) or reverse (R).

## AUTOMATIC RETURN TO PARK (P)

### WHAT IS AUTOMATIC RETURN TO PARK (P)

Your vehicle shifts into park (P) if you attempt to exit your vehicle without the selector lever in park (P).

## HOW DOES AUTOMATIC RETURN TO PARK (P) WORK

Your vehicle shifts into park (P) when your vehicle is stationary and any of the following occur:

- You switch the vehicle off.
- You open the driver door with your seatbelt unlatched.
- You unlatch the driver seatbelt when the driver door is open.

**Note:** Do not use automatic return to park (P) when your vehicle is moving, except in an emergency.

## AUTOMATIC RETURN TO PARK (P) LIMITATIONS

Automatic return to park (P) may not work if the door ajar switch is malfunctioning.

See an authorized dealer if any of the following occur:

- Door ajar indicator does not illuminate with the driver door open.
- Door ajar indicator illuminates with the driver door closed.
- Transmission not in park message appears with the driver door closed, after you shift out of park (P).

## STOWING THE SELECTOR LEVER - VEHICLES WITH: CONSOLE SHIFT

Press the stow button to fold down the selector lever. Press the button again to release the selector lever from the stow position.

The stow function allows the shifter to lay flat in the console, allowing you to use the working surface tray.

# Electric Motor

---

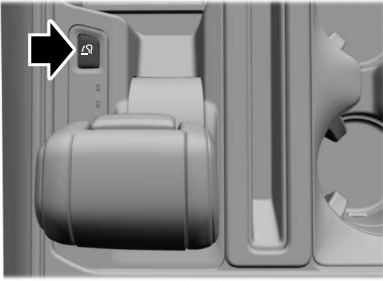

**Note:** Do not store objects in the selector lever stow bin, and be sure that the bottom selector lever tray mat is flat inside the selector lever stow bin.

**Note:** If there are objects in the stow bin while stowing the selector lever, the selector lever could come back to the upright park (P) position.

# Four-Wheel Drive

## HOW DOES FOUR-WHEEL DRIVE WORK

The four-wheel drive system is designed to continuously monitor and adjust power delivery to the front and rear wheels to optimize traction and handling.

For additional information on driving in unique driving conditions. See **Electric Vehicle** (page 416).

## FOUR-WHEEL DRIVE PRECAUTIONS



**WARNING:** Do not become overconfident in the ability of four-wheel drive vehicles. Although a four-wheel drive vehicle may accelerate better than a two-wheel drive vehicle in low traction situations, it won't stop any faster than two-wheel drive vehicles. Always drive at a safe speed.

Truck and utility vehicles can differ from some other vehicles. Your vehicle could be higher to allow it to travel over rough terrain without getting stuck or damaging underbody components. The differences that make your vehicle so versatile also make it handle differently than an ordinary passenger car. Always maintain steering wheel control, especially in rough terrain. Since sudden changes in terrain can result in abrupt steering wheel motion, make sure

you grip the steering wheel from the outside. Do not grip the spokes. Drive cautiously to avoid vehicle damage from concealed objects such as rocks and stumps. Drive slower in strong crosswinds which can affect the normal steering characteristics of your vehicle. Be extremely careful when driving on pavement made slippery by loose sand, water, gravel, snow or ice.

## FOUR-WHEEL DRIVE LIMITATIONS

The four-wheel drive system is not intended for use with mismatched tires. Different tire sizes between the front and rear axles can cause system damage.

## FOUR-WHEEL DRIVE – TROUBLESHOOTING

### FOUR-WHEEL DRIVE – WARNING LAMPS



Illuminates when a four-wheel drive or power train fault is present.

**Note:** When a system fault is present, the system can typically remain in whichever mode was selected prior to the fault condition occurring. It does not default to two-wheel drive in all circumstances. When this warning is displayed, have your vehicle serviced by an authorized dealer.

# Four-Wheel Drive

---

## FOUR-WHEEL DRIVE – INFORMATION MESSAGES

<b>Message</b>	<b>Action</b>
4WD Temporarily Disabled	The four-wheel drive system temporarily turns off to protect itself from overheating.
4WD Off	The four-wheel drive system is not operating properly. If the warning stays on or continues to come on, contact an authorized dealer.
4WD Restored	The four-wheel drive system will resume normal function.

# Electronic Locking Differential

---

## WHAT IS THE ELECTRONIC LOCKING DIFFERENTIAL

The electronic locking differential is a device housed in the rear axle, and can provide additional traction when needed.

## HOW DOES THE ELECTRONIC LOCKING DIFFERENTIAL WORK

You can activate the differential electronically and shift it on the fly within the operating speed range. The electronic differential disengages when the vehicle speed exceeds a set value, and reengages when the vehicle speed goes below a set value. See **Switching the Electronic Locking Differential On and Off** (page 234). It also engages based on certain selected drive modes. See **Selecting a Drive Mode** (page 294). The electronic locking differential is for use in mud, rocks, sand, or any off-road condition where you need maximum traction.

**Note:** *The electronic locking differential can activate or deactivate automatically based on speed, four-wheel drive mode, and drive mode selection. See **Switching the Electronic Locking Differential On and Off** (page 234).*

**Note:** *The electronic locking differential is for off-road use only and is not for use on dry pavement. Using the electronic locking differential on dry pavement results in increased tire wear, noise and vibration.*

## ELECTRONIC LOCKING DIFFERENTIAL PRECAUTIONS

### Operating the Electronic Locking Differential with a Spare or Mismatched Tires

On vehicles with an electronic locking differential, the size of the spare tire can affect performance of the system. If there is a significant difference between the two rear tires, you may have limited electronic locking differential functionality. If the system has difficulty disengaging, release the accelerator pedal and turn the steering wheel in the opposite direction when rolling. We recommend engaging and disengaging the electronic locking differential at a stop when you mount a spare on the rear axle.

# Electronic Locking Differential

## SWITCHING THE ELECTRONIC LOCKING DIFFERENTIAL ON AND OFF - 4X4

### 4X4 Rear Electronic Locking Differential Engagement Speed and Availability

Drive Modes	Maximum Engagement Speed	Automatic Disengagement Speed	Automatic Re-Engagement Speed
Normal	20 mph (30 km/h)	25 mph (41 km/h)	20 mph (30 km/h)
Sport	20 mph (30 km/h)	25 mph (41 km/h)	20 mph (30 km/h)
Tow/Haul	20 mph (30 km/h)	25 mph (41 km/h)	20 mph (30 km/h)
Off-Road	No Speed Limit	No Speed Limit	No Speed Limit

**Note:** The electronic locking differential does not have a physical switch on the console, but can be switched on and off thru the center display.

**Note:** The electronic locking differential can engage in specific drive modes.

**Note:** The electronic locking differential can activate or deactivate based on speed and drive mode selection. See **Selecting a Drive Mode** (page 294).

**Note:** The electronic locking differential may not engage if you press your accelerator pedal during an engagement attempt. A message could display in the instrument display guiding you to release the accelerator pedal.

**Note:** If the electronic locking differential has difficulty disengaging, release the accelerator pedal and turn the steering wheel in the opposite direction while rolling.

## ELECTRONIC LOCKING DIFFERENTIAL INDICATORS



**Amber Color:** This indicator illuminates in amber when the electronic locking differential is on, indicating that both rear wheel axle shafts are locked together providing added traction.

**Gray Color:** This indicator illuminates in gray when the electronic locking differential has been requested to activate but the vehicle speed is too high, or the left and right wheel speed difference is too high during an engagement attempt.

If the electronic locking differential has been selected, but has malfunctioned, a message appears in the information display. See your authorized dealer for assistance.

**Note:** If the vehicle is experiencing an anti-lock braking event, the electronic locking differential may momentarily disengage.

# Electronic Locking Differential

---

## ELECTRONIC LOCKING DIFFERENTIAL – TROUBLESHOOTING

### ELECTRONIC LOCKING DIFFERENTIAL – INFORMATION MESSAGES

<b>Message</b>	<b>Description and Action</b>
To Engage Locking Differential Slow to XX mph/km/h	The electronic locking differential has been requested and will engage when the speed condition is met.
To Engage Locking Differential Release Accelerator Pedal	Release the accelerator pedal in order to engage.
Check Locking Differential	An electronic locking differential system fault is present. Contact an authorized dealer as soon as possible.

# Brakes

## BRAKE PRECAUTIONS



**WARNING:** Driving your vehicle with the warning lamp on is dangerous. A significant decrease in braking performance may occur. It may take you longer to stop your vehicle. Have your vehicle checked as soon as possible. Driving extended distances with the parking brake engaged can cause brake failure and the risk of personal injury.

Wet brakes result in reduced braking efficiency. Gently press the brake pedal a few times when leaving a car wash or driving from standing water to dry the brakes.

**Note:** Depending on applicable laws and regulations in the country for which your vehicle was originally built, the stoplamps could flash during heavy braking. Following this the hazard warning flashers could also turn on when your vehicle comes to a stop.

## ANTI-LOCK BRAKING SYSTEM

### ANTI-LOCK BRAKING SYSTEM LIMITATIONS

The anti-lock braking system does not eliminate the risk of crash when:

- You drive too closely to the vehicle in front of you.
- Your vehicle is hydroplaning.
- You take corners too fast.
- The road surface is poor.

**Note:** If the system activates, the brake pedal could pulse and travel further. Maintain pressure on the brake pedal.

## BRAKE OVER ACCELERATOR

If your accelerator pedal becomes stuck or trapped:

- Apply steady and firm pressure to the brake pedal to slow the vehicle and reduce power.
- Bring your vehicle to a complete stop and place it in park (P).
- Switch the power off.
- Apply the parking brake.

Inspect the accelerator pedal for any interference. If none are found and the condition persists, have your vehicle checked as soon as possible. If your vehicle has to be towed, we recommend that you contact a professional towing service.

## LOCATING THE BRAKE FLUID RESERVOIR

See **Under Hood Overview** (page 436).

## CHECKING THE BRAKE FLUID



**WARNING:** Do not use any fluid other than the recommended brake fluid as this will reduce brake efficiency. Use of incorrect fluid could result in the loss of vehicle control, serious personal injury or death.



**WARNING:** Only use brake fluid from a sealed container. Contamination with dirt, water, petroleum products or other materials may result in brake system damage or failure. Failure to adhere to this warning could result in the loss of vehicle control, serious personal injury or death.



# Brakes



**WARNING:** Do not allow the fluid to touch your skin or eyes. If this happens, rinse the affected areas immediately with plenty of water and contact your physician.



**WARNING:** The brake system could be affected if the brake fluid level is below the **MIN** mark or above the **MAX** mark on the brake fluid reservoir.



1. Park your vehicle on a level surface.
2. Look at the brake fluid reservoir to see where the brake fluid level is relative to the **MIN** and the **MAX** marks on the reservoir.

**Note:** To avoid fluid contamination, the reservoir cap must remain in place and fully tight, unless you are adding fluid.

Only use fluid that meets our specifications. See **Capacities and Specifications** (page 480).

## BRAKE FLUID SPECIFICATION

See **Brake Fluid Specification** (page 482).

## BRAKES – TROUBLESHOOTING

### BRAKES – WARNING LAMPS



If the ABS indicator illuminates when you are driving, this indicates a malfunction. Your vehicle continues to have normal braking without the anti-lock braking system function. See an authorized dealer.

It also momentarily illuminates when you switch the ignition on to confirm the lamp is functional. If it does not illuminate when you switch the ignition on, or begins to flash at any time, have the system checked by an authorized dealer.

### BRAKE



The brake indicator momentarily illuminates when you switch the ignition on to confirm the lamp is functional. It may also illuminate when you apply the parking brake and the ignition is on. If it illuminates when your vehicle is moving, make sure the parking brake is disengaged. If the parking brake is disengaged, this indicates low brake fluid level or a brake system fault. See an authorized dealer.

## **BRAKES – FREQUENTLY ASKED QUESTIONS**

### **Is it normal for my brakes to make noise?**

Occasional brake noise is normal. If a metal-to-metal, continuous grinding, or continuous squeal sound is present, the brake lining could be worn-out. Have the system checked by an authorized dealer.

### **There is an electrical motor sound when I press on the brake pedal or activate the park brake switch. Is this normal?**

Yes, those sounds are the electronic brake booster or the electronic park brake operating.

**Note:** *Brake dust could accumulate on the wheels, even under normal driving conditions. Some dust is normal as the brakes wear and does not contribute to brake noise. See **Cleaning Wheels** (page 443).*

# Electric Parking Brake

## WHAT IS THE ELECTRIC PARKING BRAKE

The electric parking brake is used to hold your vehicle on slopes and flat roads.

## APPLYING THE ELECTRIC PARKING BRAKE



**WARNING:** Always fully apply the parking brake. Failure to follow this instruction could result in personal injury or death.



**WARNING:** If you drive extended distances with the parking brake applied, you could cause damage to the brake system.



The switch is on the lower part of the instrument panel.

Pull the switch up to apply the electric parking brake. The red warning lamp flashes, then steadily illuminates when the parking brake is applied.

**Note:** You can apply the electric parking brake when the ignition is off.

**Note:** The electric parking brake could apply when park (P) is selected. See **Park (P)** (page 227).

## APPLYING THE ELECTRIC PARKING BRAKE IN AN EMERGENCY

You can use the electric parking brake to slow or stop your vehicle in an emergency.

1. Pull the switch up and hold it.

The electric parking brake continues to slow your vehicle down unless you release the switch.

The red warning lamp illuminates, a tone sounds and the stoplamps turn on when you use the electric parking brake in an emergency.

**Note:** Do not apply the electric parking brake when your vehicle is moving, except in an emergency. If you repeatedly use the electric parking brake to slow or stop your vehicle, you could cause damage to the brake system.

## MANUALLY RELEASING THE ELECTRIC PARKING BRAKE

1. Switch the ignition on.
2. Press and hold the brake pedal.
3. Push the switch down.

The red warning lamp turns off.

## Pulling Away on a Hill When Towing a Trailer

1. Press and hold the brake pedal.
2. Pull the switch upward and hold it.
3. Shift into gear.
4. Press the accelerator pedal until engine has developed sufficient torque to prevent your vehicle from rolling down the hill.
5. Release the switch and pull away in a normal manner.

## AUTOMATICALLY RELEASING THE ELECTRIC PARKING BRAKE

1. Close the driver door.
2. Shift into gear.

# Electric Parking Brake

3. Press the accelerator pedal and pull away in a normal manner.

## ELECTRIC PARKING BRAKE AUDIBLE WARNING

Sounds when the parking brake is on and your vehicle is moving. If the warning tone continues after you have released the parking brake, this indicates a malfunction. Have your vehicle checked as soon as possible.

## RELEASING THE ELECTRIC PARKING BRAKE IF THE VEHICLE BATTERY HAS RUN OUT OF CHARGE



**WARNING:** The electric parking brake does not operate if the vehicle battery has run out of charge.

Connect a booster battery to the vehicle battery to release the electric parking brake if the vehicle battery has run out of charge. See **Jump Starting the Vehicle** (page 421).

## ELECTRIC PARKING BRAKE – TROUBLESHOOTING

### ELECTRIC PARKING BRAKE – WARNING LAMPS

#### Brake System



It illuminates red when you apply the parking brake and your vehicle is on. If the lamp flashes when the parking brake has been released, this indicates the parking brake system requires service. Have your vehicle checked as soon as possible.

**Note:** *Lamps may vary depending on region.*

#### Electric Parking Brake



When the lamp illuminates yellow, it indicates a malfunction in the electric parking brake. Have your vehicle checked as soon as possible.

# Electric Parking Brake

## ELECTRIC PARKING BRAKE – INFORMATION MESSAGES

<b>Message</b>	<b>Action</b>
To Release: Press Brake and Switch	The electric parking brake is set and a manual release is attempted without the brake pedal being pressed.
Park Brake Use Switch to Release	The electric parking brake is set and an automatic release is attempted but cannot be performed. Perform a manual release.
Release Park Brake	The electric parking brake is set and your vehicle speed exceeds 3 mph (5 km/h). Release the parking brake before continuing driving.
Park Brake Not Applied	The electric parking brake is not fully applied.
Park Brake Not Released	The electric parking brake is not fully released.
Brake maintenance mode	The electric parking brake system has been put into a special mode that is used to allow service of the brakes. Contact an authorized dealer.
Park Brake Limited Function Service Required	The electric parking brake system has detected a condition that requires service. Some functionality may still be available. Contact an authorized dealer.
Park Brake Malfunction Service Now	The electric parking brake system has detected a condition that requires service. Contact an authorized dealer.

## Reverse Braking Assist (If Equipped)

### WHAT IS REVERSE BRAKING ASSIST

Reverse braking assist is designed to reduce impact damage or assist in avoiding a collision while in reverse (R). Using sensors on the rear of the vehicle, it can detect a possible collision and apply the brakes. If full braking occurs, the system attempts to stop the vehicle a safe distance from the obstacle.

### HOW DOES REVERSE BRAKING ASSIST WORK

Reverse braking assist functions when in reverse (R) and traveling at a speed of 1–7 mph (2–12 km/h).

If the system detects an obstacle behind your vehicle, it provides a warning through the rear parking aid or cross traffic alert system.

### REVERSE BRAKING ASSIST PRECAUTIONS



**WARNING:** You are responsible for controlling your vehicle at all times. The system is designed to be an aid and does not relieve you of your responsibility to drive with due care and attention. Failure to follow this instruction could result in the loss of control of your vehicle, personal injury or death.



**WARNING:** To help avoid personal injury, always use caution when in reverse (R) and when using the sensing system.



**WARNING:** The system may not operate properly during severe weather conditions, for example snow, ice, heavy rain and spray. Always drive with due care and attention. Failure to take care may result in a crash.



**WARNING:** Traffic control systems, fluorescent lamps, inclement weather, air brakes, external motors and fans may affect the correct operation of the sensing system. This may cause reduced performance or false alerts.



**WARNING:** Some situations and objects prevent hazard detection. For example low or direct sunlight, inclement weather, unconventional vehicle types, and pedestrians. Apply the brakes when necessary. Failure to follow this instruction could result in the loss of control of your vehicle, personal injury or death.



**WARNING:** Do not use the system with accessories that extend beyond the front or rear of your vehicle, for example a trailer hitch or bike rack. The system is not able to make corrections for the additional length of the accessories.

The system only applies the brakes for a short period of time when an event occurs. Act as soon as you notice the brakes apply to remain in control of the vehicle. If you do not intervene the vehicle may start to move again.

**Note:** *Certain add-on devices around the bumper or fascia may create false alerts. For example, large trailer hitches, bicycle or surfboard racks, license plate brackets, bumper covers or any other device that may block the normal detection zone of the system. Remove the add-on device to prevent false alerts.*

## Reverse Braking Assist (If Equipped)

**Note:** The system does not react to small or moving objects, particularly those close to the ground.

**Note:** The system does not operate during hard acceleration or steering.

**Note:** If your vehicle sustains damage to the bumper or fascia leaving it misaligned or bent, it could alter the sensing zone causing inaccurate measurement of obstacles or false alerts.

**Note:** Vehicle loading and suspension changes can impact the angle of the sensors and may change the normal detection zone of the system resulting in inaccurate measurement of obstacles or false alerts.

**Note:** When you connect a trailer, the system may detect the trailer and provide an alert, or the system turns off. If the system does not turn off, manually switch the system off after you connect the trailer.

**Note:** You may experience reduced system performance on road surfaces that limit deceleration. For example, roads with ice, loose gravel, mud or sand.

### SWITCHING REVERSE BRAKING ASSIST ON AND OFF - VEHICLES WITH: 12.3 INCH SCREEN

1. Press **Features** on the touchscreen.
2. Press **Driver Assistance**.
3. Switch **Reverse Brake Assist** on or off.

**Note:** The system is unavailable when the rear parking aid, cross traffic alert or traction control is off.

**Note:** If your vehicle is not equipped with cross traffic alert the reverse braking assist relies on input from the rear parking aid and rear camera sensors.

**Note:** The default setting is on in some regions.

### SWITCHING REVERSE BRAKING ASSIST ON AND OFF - VEHICLES WITH: 15 INCH SCREEN

1. Access the vehicle drawer on the touchscreen.
2. Press **SETTINGS**.
3. Press **Driver Assistance**.
4. Switch **Reverse Brake Assist** on or off.

**Note:** The system is unavailable when the rear parking aid, cross traffic alert or traction control is off.

**Note:** If your vehicle is not equipped with cross traffic alert the reverse braking assist relies on input from the rear parking aid and rear camera sensors.

**Note:** The default setting is on in some regions.

### OVERRIDING REVERSE BRAKING ASSIST

There could be instances when unexpected or unwanted braking occurs. Firmly pressing the accelerator pedal or switching the feature off overrides the system.

### REVERSE BRAKING ASSIST INDICATORS

If the system determines that a collision with an obstacle may occur, full braking may apply.



A message and warning indicator appear when the system applies the brakes.

## Reverse Braking Assist (If Equipped)

---

### REVERSE BRAKING ASSIST – TROUBLESHOOTING

#### REVERSE BRAKING ASSIST – INFORMATION MESSAGES

Message	Action
Reverse Brake Assist Not Available See Manual	Make sure that all doors, liftgate or tailgate and hood are closed. Drive the vehicle on a straight road for a short period. Make sure the parking aids and cross traffic alert systems are on. If the message remains on, have the system checked as soon as possible.
Reverse Brake Assist Fault	Displays when a system error has occurred. Have your vehicle checked as soon as possible.
Reverse Brake Assist Off	Displays when reverse brake assist is off.



## Reverse Braking Assist (If Equipped)

---

### REVERSE BRAKING ASSIST – FREQUENTLY ASKED QUESTIONS

Why is reverse braking assist unavailable?

- Make sure the reverse braking assist is on. See **Switching Reverse Braking Assist On and Off** (page 243).
- Make sure that all doors, liftgate or tailgate and hood are closed. Drive the vehicle on a straight road for a short period. If the message remains, have the system checked.
- Make sure the cross traffic alert system is on if equipped. See **Switching Cross Traffic Alert On and Off** (page 310).
- Make sure the rear parking aid system is on. See **Rear Parking Aid** (page 255).
- Make sure the traction control is on. See **Switching Traction Control On and Off** (page 249).

**Note:** *The traction control automatically turns off if four-wheel drive low and certain drive modes such as mud/ruts and snow/sand is activated.*

- The vehicle may have sustained a rear end impact. Have the sensors checked for proper coverage and operation.
- An anti-lock brake, traction control or stability control event may have occurred. Reverse braking assist resumes operation when the event is complete.
- Make sure the rear view camera and 360 degree camera are not dirty or obstructed. If dirty, clean the camera. If the message still appears after cleaning the camera, wait a short time for the message to clear. If the message does not clear, have the system checked.

- Make sure the cross traffic alert and rear parking aid sensors are not blocked or faulty. See **Locating the Cross Traffic Alert Sensors** (page 310). See **Locating the Rear Parking Aid Sensors** (page 255).
- You recently had your vehicle serviced, or the battery disconnected. Drive your vehicle a short distance to resume system operation.
- Reverse braking assist does not function when you connect a trailer. Operation resumes when you disconnect the trailer.

**Note:** *If the answers to why the system is unavailable do not assist in returning reverse braking assist to available, have the system checked as soon as possible.*

# Hill Start Assist

## WHAT IS HILL START ASSIST

Hill Start Assist makes it easier for you to pull away when your vehicle is on a slope without using the parking brake.

## HOW DOES HILL START ASSIST WORK

When the system activates, your vehicle remains stationary for a few seconds after you release the brake pedal. This gives you time to move your foot from the brake pedal to the accelerator pedal. The brakes release when the electric motors provide propulsion to prevent your vehicle from rolling down slope.

## HILL START ASSIST PRECAUTIONS



**WARNING:** The system does not replace the parking brake. When you leave your vehicle, always apply the parking brake.



**WARNING:** You must remain in your vehicle when the system turns on. At all times, you are responsible for controlling your vehicle, supervising the system and intervening, if required. Failure to take care may result in the loss of control of your vehicle, serious personal injury or death.



**WARNING:** The system will turn off if a malfunction is apparent. Failure to take care may result in the loss of control of your vehicle, serious personal injury or death.

## HILL START ASSIST – TROUBLESHOOTING

## HILL START ASSIST – INFORMATION MESSAGES

Message	Action
Hill Start Assist Not Available	Displays when system is not available. Have your vehicle checked as soon as possible.

# Auto Hold

## HOW DOES AUTO HOLD WORK

Auto hold applies the brakes to hold your vehicle after you bring the vehicle to a stop. This can help when waiting on a hill or in traffic.

## SWITCHING AUTO HOLD ON AND OFF - VEHICLES WITH: 12.3 INCH SCREEN



**WARNING:** The system does not replace the parking brake. When you leave your vehicle, always apply the parking brake.



**WARNING:** You must remain in your vehicle when the system turns on. At all times you are responsible for controlling your vehicle, supervising the system, and intervening if required. Failure to follow this instruction could result in the loss of control of your vehicle, personal injury or death.

You can switch the system on or off by accessing the menu in the SYNC display screen.

1. Press **Features** on the touchscreen.
2. Press **Driver Assistance**.

**Note:** You can only switch the system on after you close the driver door.

**Note:** The system remembers the last setting when you start your vehicle.

**Note:** When using an automatic car wash, make sure to switch auto hold off or shift to neutral (N) with the brake pedal applied to ensure auto hold is not active.

## SWITCHING AUTO HOLD ON AND OFF - VEHICLES WITH: 15 INCH SCREEN



**WARNING:** The system does not replace the parking brake. When you leave your vehicle, always apply the parking brake.



**WARNING:** You must remain in your vehicle when the system turns on. At all times, you are responsible for controlling your vehicle, supervising the system and intervening, if required. Failure to take care may result in the loss of control of your vehicle, serious personal injury or death.

You can switch the system on or off by accessing the menu in the SYNC display screen.

1. Access the vehicle drawer on the touchscreen.
2. Press **Settings**.
3. Press **Driver Assistance**.
4. Switch Auto Hold on or off.

**Note:** You can only switch the system on after you close the driver door.

**Note:** The system remembers the last setting when you start your vehicle.

**Note:** When using an automatic car wash, make sure to switch auto hold off or shift to neutral with the brake pedal applied to ensure auto hold is not active.

## USING AUTO HOLD

1. Bring your vehicle to a complete stop. The auto hold active indicator illuminates in the information display.

# Auto Hold

---

2. Release the brake pedal. The system holds your vehicle at a standstill. The auto hold active indicator remains illuminated in the information display.
3. Pull away in the normal manner. The system releases the brakes and the auto hold active indicator switches off.

**Note:** *The system only activates if you apply enough pressure on the brake pedal to bring the vehicle to standstill.*

**Note:** *Under certain conditions, the system could apply the electric parking brake. The brake system warning lamp illuminates. The electric parking brake releases when you press the accelerator pedal. See **Automatically Releasing the Electric Parking Brake** (page 239).*

**Note:** *The system switches off if you shift into reverse (R) or neutral (N) while pressing the brake pedal. If you do not press the brake pedal while shifting into reverse (R) or neutral (N), auto hold continues to hold the vehicle. In this case, pressing the brake pedal causes auto hold to stop holding the vehicle.*

The auto hold system does not work when any of the following actions are performed:

- When you use active park assist.
- Your vehicle is in stay in neutral mode.
- The driver door is open.
- You shift into reverse (R) or neutral (N) before the system is active.
- Trail Control or Trail One Pedal are active.

## AUTO HOLD INDICATORS



Illuminates when the system is active.



Illuminates when the system is on but cannot hold your vehicle at a standstill at this particular time.

# Traction Control

## WHAT IS TRACTION CONTROL

The traction control system helps to avoid drive wheel spin and loss of traction.

## HOW DOES TRACTION CONTROL WORK

If your vehicle begins to slide, the system applies the brakes to individual wheels and, when needed, reduces power at the same time. If the wheels spin when accelerating on slippery or loose surfaces, the system reduces power in order to increase traction.

## SWITCHING TRACTION CONTROL ON AND OFF



**WARNING:** Operating your vehicle with the traction control disabled could lead to an increased risk of loss of vehicle control, vehicle rollover, personal injury and death.



The traction control system turns on each time you switch the ignition on.

The button for the stability and traction control system is on the instrument panel.

Press and release the button to switch traction control off. The stability control system remains fully active, to switch it off, press and hold the button for a few seconds, then release.

When you switch traction control off, a message and an illuminated icon appear on the instrument cluster.

Press the switch again to turn the traction control system back on to normal operation.

If your vehicle is stuck in mud or snow, switching traction control off may be beneficial as this allows the wheels to spin.

Your vehicle may have MyKey restrictions regarding this feature. See **What Is MyKey** (page 76).

## TRACTION CONTROL INDICATOR

### System Indicator Lights



# Traction Control

---

## TRACTION CONTROL – TROUBLESHOOTING

### TRACTION CONTROL – INFORMATION MESSAGES

<b>Message</b>	<b>Action</b>
Service AdvanceTrac	The system detects a condition that requires service. Contact an authorized dealer as soon as possible.
AdvanceTrac Off	The status of the AdvanceTrac system after you switched it off.
AdvanceTrac On	The status of the AdvanceTrac system after you switched it on.
Traction Control Off	The status of the traction control system after you switched it off.
Traction Control On	The status of the traction control system after you switched it on.

# Stability Control

## HOW DOES STABILITY CONTROL WORK



**WARNING:** Vehicle modifications involving braking system, aftermarket roof racks, suspension, steering system, tire construction and wheel and tire size may change the handling characteristics of your vehicle and may adversely affect the performance of the electronic stability control system. In addition, installing any stereo loudspeakers may interfere with and adversely affect the electronic stability control system. Install any aftermarket stereo loudspeaker as far as possible from the front center console, the tunnel, and the front seats in order to minimize the risk of interfering with the electronic stability control sensors. Reducing the effectiveness of the electronic stability control system could lead to an increased risk of loss of vehicle control, vehicle rollover, personal injury and death.



**WARNING:** Remember that even advanced technology cannot defy the laws of physics. It's always possible to lose control of a vehicle due to inappropriate driver input for the conditions. Aggressive driving on any road condition can cause you to lose control of your vehicle increasing the risk of personal injury or property damage. Activation of the electronic stability control system is an indication that at least some of the tires have exceeded their ability to grip the road; this could reduce the operator's ability to control the vehicle potentially resulting in a loss of vehicle control, vehicle rollover, personal injury and death. If your electronic stability control system activates, SLOW DOWN.

If a driving condition activates either the stability control or the traction control system you may experience the following conditions:

- The stability and traction control light flashes.
- Your vehicle slows down.
- Reduced power.

The stability control system has several features built into it to help you maintain control of your vehicle:

### Electronic Stability Control

Electronic stability control enhances your vehicle's ability to prevent skids or lateral slides by applying brakes to one or more of the wheels individually and, if necessary, reducing power.

### Curve Control

Curve control enhances your vehicle's ability to follow the road when cornering severely or avoiding objects in the roadway. Curve control operates by reducing power and, if necessary, applying brakes to one or more of the wheels individually.

### Traction Control

Traction control enhances your vehicle's ability to maintain traction of the wheels by detecting and controlling wheel spin. See **What Is Traction Control** (page 249).

# Stability Control

B Vehicle with stability control maintaining control on a slippery surface.

## SWITCHING STABILITY CONTROL ON AND OFF

Stability control turns on each time you switch the ignition on.

Turn stability control off by pressing and holding the stability and traction control button for 5-15 seconds.

To turn the system on, press and release the stability and traction control button.

Shifting the transmission into reverse (R) disables the system.

You can switch the traction control system off or on independently. See **Switching Traction Control On and Off** (page 249).

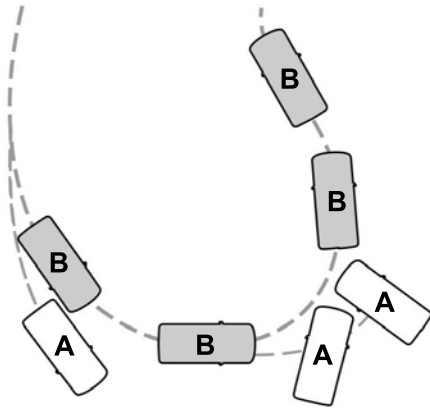

A Vehicle without stability control skidding off its intended route.

## Stability Control and Traction Control with Roll Stability Control

	Stability Control OFF Light	Roll Stability Control <sup>3</sup>	Electronic Stability Control <sup>3</sup>	Traction Control System <sup>3</sup>
Default at start-up	Illuminated during bulb check	Enabled	Enabled <sup>3</sup>	Enabled
Button pressed momentarily	Illuminated	Enabled	Enabled <sup>3</sup>	Disabled <sup>1</sup>
Button pressed and held for 5 - 15 seconds	Illuminated	Enabled	Disabled <sup>2</sup>	Disabled <sup>1</sup>

<sup>1</sup> The Traction control system can still be enabled but with tighter or looser thresholds.

<sup>2</sup> When you press and hold the button, a progress bar displays to show the button hold time progress.

<sup>3</sup> Functions can vary depending on what selectable drive mode the vehicle is currently in.



# Steering

## ELECTRIC POWER STEERING

### ELECTRIC POWER STEERING PRECAUTIONS



**WARNING:** The electric power steering system has diagnostic checks that continuously monitor the system. If a fault is detected, a message displays in the information display. Stop your vehicle as soon as it is safe to do so. Switch the vehicle off. After at least 10 seconds, switch the vehicle on and watch the information display for a steering system warning message. If a steering system warning message returns, have the system checked as soon as possible.



**WARNING:** If the system detects an error, you may not feel a difference in the steering, however a serious condition may exist. Have your vehicle checked as soon as possible. Failure to do so may result in loss of steering control.

Adapt your speed and driving behavior according to reduced steering assist.

Extreme continuous steering may increase the effort to steer. This occurs to prevent internal overheating and damage to the steering system. If this occurs, you will not lose the ability to steer your vehicle manually nor will it cause damage to the system. Normal steering and driving allows the system to cool down and steering assist returns to normal.

**Note:** *There is no fluid reservoir to check or fill.*

## STEERING – TROUBLESHOOTING

### STEERING – INFORMATION MESSAGES

Message	Action
Steering Fault Service Now	The power steering system has detected a condition that requires service. Have your vehicle checked as soon as possible.
Steering Loss Stop Safely	The power steering system is not working. Stop your vehicle in a safe place. Have your vehicle checked as soon as possible.
Steering Assist Fault Service Required	The power steering system has detected a condition that requires service. Have your vehicle checked as soon as possible.

# Parking Aids (If Equipped)

## PARKING AID PRECAUTIONS



**WARNING:** To help avoid personal injury, always use caution when in reverse (R) and when using the sensing system.



**WARNING:** The system may not detect objects with surfaces that absorb reflection. Always drive with due care and attention. Failure to take care may result in a crash.



**WARNING:** Traffic control systems, fluorescent lamps, inclement weather, air brakes, external motors and fans may affect the correct operation of the sensing system. This may cause reduced performance or false alerts.



**WARNING:** The system may not detect small or moving objects, particularly those close to the ground.



**WARNING:** The parking aid system can only assist you to detect objects when your vehicle is moving at parking speeds. To help avoid personal injury you must take care when using the parking aid system.



**WARNING:** The system may not function if the sensor is blocked.



**WARNING:** In cold and severe weather conditions the system may not function. Rain, snow and spray can all limit sensor performance.



**WARNING:** If damage occurs in the immediate area surrounding the sensor, have your vehicle checked as soon as possible.

**Note:** If your vehicle sustains damage leaving the sensors misaligned, this will cause inaccurate measurements or false alerts.

When you connect a trailer to your vehicle, the rear parking aid detects the trailer and provides an alert. Disable the parking aid when you connect a trailer to prevent the alert.

**Note:** Connected trailers might be detected by the vehicle and parking aid turns off automatically in those instances.

**Note:** Certain add-on devices installed around the bumper or fascia may create false alerts, for example, large trailer hitches, bike or surfboard racks, license plate brackets, bumper covers or any other device that could block the normal detection zone of the parking aid system. Aftermarket spare tires or spare tire covers mounted to the rear tailgate could cause false alerts from the park aid system. Remove the add-on device to prevent false alerts.

**Note:** Keep the sensors free from snow, ice and large accumulations of dirt. If the sensors are covered, the system's accuracy can be affected.

Do not clean the sensors with sharp objects.

**Note:** When using a programmed MyKey, you cannot switch the parking aids off. See **MyKey™** (page 76).

## SWITCHING PARKING AID ON AND OFF - VEHICLES WITH: 15 INCH SCREEN



Press the parking aid button and use the menu to switch the system on and off.

The system can be set to stay disabled in between ignition cycles.

## Parking Aids (If Equipped)

1. Access the vehicle drawer on the touchscreen.
2. Press **SETTINGS**.
3. Press **Driver Assistance**.
4. Press **Park Aid Sensors**.
5. Switch **Front Sensors (Always)** or **Rear Sensors (Always)** on or off.

### SWITCHING PARKING AID ON AND OFF - VEHICLES WITH: 12.3 INCH SCREEN



Press the parking aid button to switch the system on and off.

#### Switching Parking Aid On and Off Long-Term

The system can be set to stay disabled in between ignition cycles.

1. Press Settings on the touchscreen.
2. Press Driver Assistance.
3. Press Park Aid Sensors.
4. Switch Front Sensors (Always) or Rear Sensors (Always) on or off.

### REAR PARKING AID (IF EQUIPPED)

#### WHAT IS THE REAR PARKING AID

Rear parking sensors detect objects behind your vehicle when in reverse (R).

#### REAR PARKING AID LIMITATIONS

There is a decreased coverage area at the outer corners.

When using a programmed MyKey, you cannot switch the rear parking aid off.

The rear parking aid sensors are active when your vehicle is in reverse (R) and the vehicle speed is less than 5 mph (8 km/h).

The sensor coverage area is up to 71 in (180 cm) from the rear bumper.

The rear parking aid detects large objects when you shift into reverse (R) and any of the following occur:

- Your vehicle is moving backward at a low speed.
- Your vehicle is stationary but an object is approaching the rear of your vehicle at a low speed.
- Your vehicle is moving backward at a low speed and an object is moving towards your vehicle, for example another vehicle at a low speed.

The system shall provide no audible warning for the object behind the vehicle when in neutral (N) gear.

#### LOCATING THE REAR PARKING AID SENSORS



The rear parking aid sensors are in the rear bumper.

## Parking Aids (If Equipped)

### REAR PARKING AID AUDIBLE WARNINGS

A warning tone sounds when your vehicle approaches an object. As your vehicle moves closer to an object, the rate of the tone increases. The warning tone continuously sounds when an object is 12 in (30 cm) or less from the rear bumper.

If your vehicle remains stationary for a few seconds, the audible warning turns off. If your vehicle moves backward the tone sounds again.

**Note:** *When the parking aid system sounds a tone, the audio system could reduce the set volume.*

### FRONT PARKING AID (IF EQUIPPED)

#### WHAT IS THE FRONT PARKING AID

Front parking sensors detect objects in front of your vehicle.

#### FRONT PARKING AID LIMITATIONS

The front parking aid sensors are active when your vehicle is in any position other than park (P) and the vehicle speed is less than 5 mph (8 km/h).

The sensor coverage area is up to 28 in (70 cm) from the bumper.

If your vehicle is in reverse (R), the front parking aid detects objects when your vehicle is moving at a low speed or an object is moving toward your vehicle and provides an audible warning, for example another vehicle at a low speed. If your vehicle remains stationary for a few seconds, the audible warning turns off. Visual indication is always active in reverse (R).

If your vehicle is in any forward gear, the front parking aid provides audible warnings and visual indication when your vehicle is moving at a speed of 5 mph (8 km/h) or below and the system detects an object within the detection zone. If your vehicle remains stationary for a few seconds, the visual indication and audible warning turns off.

If your vehicle is in neutral (N), the front and rear sensors provide visual indication only when your vehicle is moving below a speed of 5 mph (8 km/h) and obstacles are detected inside the detection areas. Once your vehicle stops, the visual indication and audible warning stops after a few seconds.

### LOCATING THE FRONT PARKING AID SENSORS



The front parking aid sensors are in the front bumper.

### FRONT PARKING AID AUDIBLE WARNINGS

A warning tone sounds when there is an object within 28 in (70 cm) from the front bumper. As your vehicle moves closer to an object, the rate of the tone increases.

# Parking Aids (If Equipped)

The warning tone continuously sounds when an object is 12 in (30 cm) or less from the front bumper.

**Note:** *If the detected object is 12 in (30 cm) or less from your vehicle, visual indication remains on.*

## SIDE PARKING AID (IF EQUIPPED)

### WHAT IS THE SIDE PARKING AID

The front and rear outermost parking aid sensors map objects that are near to the sides of your vehicle.

### SIDE PARKING AID LIMITATIONS

The sensor coverage is up to 24 in (60 cm) from the sides of your vehicle.

The side parking aid may not function if:

- Your vehicle remains stationary for over two minutes.
- The anti-lock brake system activates.
- The traction control system activates.
- Your vehicle is in park (P).
- The steering wheel angle information is not available. You must drive at least 492 ft (150 m) above 19 mph (30 km/h) to reset the steering wheel angle information.

**Note:** *If you switch traction control off, the side sensing system also turns off.*

To reinitialize the system, drive the length of your vehicle.

The side parking aid does not detect an object that is moving toward the side of your vehicle, for example another vehicle moving at a low speed, if it does not pass a front or rear parking aid sensor.

If the transmission is in reverse (R), the side sensing system provides audible warnings. When your vehicle is moving slowly, obstacles are detected within 24 in (60 cm) and are inside the driving path of your vehicle. If your vehicle remains stationary for a few seconds, the audible warning turns off. Visual indication is always present in reverse (R).

If your vehicle is in neutral (N), the side sensing system provides visual indication only when your vehicle is moving slowly and there is a front or rear parking aid obstacle detected, and the side obstacle is within 24 in (60 cm) from the side of your vehicle. If your vehicle remains stationary for a few seconds, the visual indication turns off.

If the transmission is in drive (D) or any other forward gear, the side sensing system provides audible and visual warnings. When your vehicle is moving slowly, obstacles are detected within 24 in (60 cm) and are inside the driving path of your vehicle. If your vehicle remains stationary for a few seconds, the visual indication and audible warning turns off.

### LOCATING THE SIDE PARKING AID SENSORS



## Parking Aids (If Equipped)

The side parking sensors are in the front and rear bumpers.

### SIDE PARKING AID AUDIBLE WARNINGS

When the side parking aid detects an object within the coverage area and the driving path of your vehicle, an audible warning sounds. As your vehicle moves closer to the object, the rate of the tone increases.

### PARKING AID INDICATORS - VEHICLES WITH: 12.3 INCH SCREEN



The system provides object distance indication through the information display.

- As the distance to the object decreases, the indicator blocks illuminate and move toward the vehicle icon.
- If there is no object detected, the distance indicator blocks are grey.

Visual indication remains on when the transmission is in reverse (R). When you stop your vehicle, visual indication turns off after four seconds.

If the parking aids are not available, the side distance indicator blocks do not display.

### PARKING AID INDICATORS - VEHICLES WITH: 15 INCH SCREEN

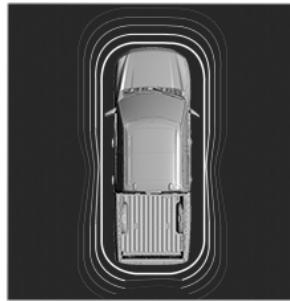

Object distance indication is displayed in the touchscreen.

- As the distance to the object decreases, the indicator waves and the lines move toward the vehicle icon.
- The distance indicators remain gray when no object is detected.

Visual indication remains on when your vehicle is in reverse (R). In any other gear, when you stop your vehicle, visual indication turns off after four seconds.

If the parking aids are not available, the side distance indicator lines do not display.

## Parking Aids (If Equipped)

---

### PARKING AIDS – TROUBLESHOOTING

If a fault is present in the parking aids, a warning message appears in the instrument cluster or the touchscreen.

### PARKING AIDS – INFORMATION MESSAGES

**Note:** *When the front or rear park aid presents a fault message, the side parking aid also disables.*

<b>Message</b>	<b>Action</b>
Park Aid Fault	The system detects a condition that requires service. Have your vehicle checked as soon as possible.
Trailer Connected	A correct trailer connection is sensed during a given ignition cycle.

# Rear View Camera

## WHAT IS THE REAR VIEW CAMERA

The rear view camera provides a video image of the area behind your vehicle when the transmission is in reverse (R).



The rear view camera button is on the instrument panel.

## REAR VIEW CAMERA PRECAUTIONS



**WARNING:** The rear view camera system is a reverse aid supplement device that still requires the driver to use it in conjunction with the interior and exterior mirrors for maximum coverage.



**WARNING:** Objects that are close to either corner of the bumper or under the bumper, might not be seen on the screen due to the limited coverage of the camera system.



**WARNING:** Reverse your vehicle slowly. Failure to follow this instruction could result in the loss of control of your vehicle, personal injury or death.



**WARNING:** Use caution when the rear cargo door is ajar. If the rear cargo door is ajar, the camera will be out of position and the video image could be incorrect. All guide lines disappear when the rear cargo door is ajar. Failure to follow this instruction could result in personal injury.



**WARNING:** Do not switch the camera features on or off when your vehicle is moving.

**Note:** When towing, the camera only sees what you are towing. This might not provide adequate coverage and you might not see some objects. In some vehicles, the guide lines may disappear when you connect the trailer tow connector.

## LOCATING THE REAR VIEW CAMERA

The rear view camera is on the tailgate. It provides a video image of the area behind your vehicle.



# Rear View Camera

## REAR VIEW CAMERA GUIDE LINES

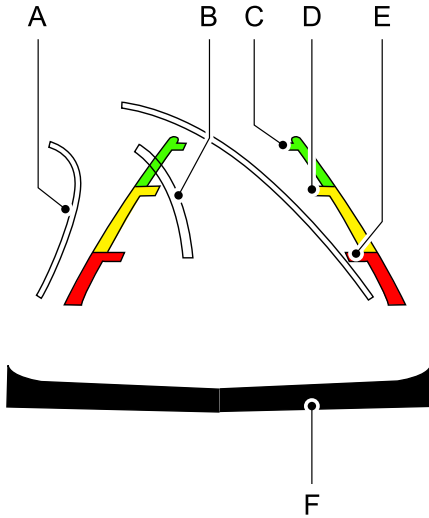

- A Active guide lines.
- B Centerline.
- C Fixed guide line: Green zone.
- D Fixed guide line: Yellow zone.
- E Fixed guide line: Red zone.
- F Rear bumper.

Active guide lines only show with fixed guide lines. To use active guide lines, turn the steering wheel to point the guide lines toward an intended path. If the steering wheel position changes while reversing, your vehicle might deviate from the intended path.

The fixed and active guide lines fade in and out depending on the steering wheel position. The active guide lines do not display when the steering wheel position is straight.

Use caution while reversing. Objects in the red zone are closest to your vehicle and objects in the green zone are farther away. Objects get closer to your vehicle as they move from the green zone to the yellow or red zones. Use the side view mirrors and rear view mirror to get better coverage on both sides and rear of your vehicle.

**Note:** Active guide lines and fixed guide lines are only available when the transmission is in reverse (R).

**Note:** The centerline is only available if the active or fixed guide lines are on.

**Note:** Not all camera modes work properly without an auxiliary camera.

## REAR VIEW CAMERA SETTINGS

### ZOOMING THE REAR VIEW CAMERA IN AND OUT

**WARNING:** When manual zoom is on, the full area behind your vehicle may not show. Be aware of your surroundings when using the manual zoom feature.

Selectable settings for this feature are zoom in (+) and zoom out (-). Press the symbol on the camera screen to change the view. The default setting is zoom off.

This allows you to get a closer view of an object behind your vehicle. The zoomed image keeps the bumper in the image to provide a reference. The zoom is only active while the transmission is in reverse (R).

# Rear View Camera

---

**Note:** Zooming in also engages park hold which applies the electric park brake when you shift to park (P). When you press the zoom button, the electronic park hold button illuminates on the touchscreen. See **Connecting a Trailer** (page 348).

**Note:** Manual zoom is only available when the transmission is in reverse (R).

**Note:** Only the centerline shows when you enable manual zoom.

**Note:** The rear normal view and hitch view are also available when your vehicle is in drive (D).

## SWITCHING REAR VIEW CAMERA DELAY ON AND OFF

1. Press **Features** on the touchscreen.
2. Press **Driver Assistance**.
3. Press **Rear View Camera**.
4. Switch **Rear View Camera Delay** on or off.

When shifting the transmission out of reverse (R) and into any gear other than park (P), the camera image remains in the display until:

- Your vehicle speed reaches approximately 5 mph (8 km/h).
- You shift your vehicle into park (P).

## SWITCHING THE REAR VIEW CAMERA VIEW



Press to access the different camera views.



Rear normal view provides an image of what is directly behind your vehicle.



Rear split view provides an extended view of what is behind your vehicle.



The hitch view provides an image of the area around the tow hitch.

## 360 Degree Camera (If Equipped)

### WHAT IS THE 360 DEGREE CAMERA

The 360 degree camera system consists of front, side and rear cameras which provide visibility around your vehicle.

### HOW DOES THE 360 DEGREE CAMERA WORK

The 360 Degree Camera system:

- Allows you to see what is directly in front of or behind your vehicle.
- Provides a cross traffic view in front of and behind your vehicle.
- Allows you to see a top-down view of the area outside your vehicle, including the blind spots and obstacles near your vehicle.

### 360 DEGREE CAMERA PRECAUTIONS

 **WARNING:** The 360 degree camera system still requires the driver to use it in conjunction with looking out of the windows, and checking the interior and exterior mirrors for maximum coverage.

 **WARNING:** Objects that are close to either corner of the bumper or under the bumper, might not be seen on the screen due to the limited coverage of the camera system.

 **WARNING:** Do not switch the camera features on or off when your vehicle is moving.

 **WARNING:** You are responsible for controlling your vehicle at all times. The system is designed to be an aid and does not relieve you of your responsibility to drive with due care and attention. Failure to follow this instruction could result in the loss of control of your vehicle, personal injury or death.

 **WARNING:** Use caution when the tailgate is ajar. If the tailgate is ajar, the camera is out of position and the video image could be incorrect. All guide lines disappear when the tailgate is ajar. Failure to follow this instruction could result in personal injury.

 **WARNING:** When manual zoom is on, the full area behind your vehicle may not show. Be aware of your surroundings when using the manual zoom feature.

### 360 DEGREE CAMERA LIMITATIONS

**Note:** Use caution if a door is ajar. The 360 degree camera could be out of position and the image could be incorrect.

### LOCATING THE 360 DEGREE CAMERAS

#### Rear View Camera

The rear view camera is on the tailgate. It provides a video image of the area behind your vehicle.

#### Front View Camera

The front view camera is in the grille. It provides a video image of the area in front of your vehicle.

## 360 Degree Camera (If Equipped)

### Side View Camera

The side view camera is on the outside mirror. It provides a video image of the area on the sides of your vehicle to aid you when parking or when backing up a trailer.

### Bed Camera

The bed camera is mounted within the high-mount stop lamp. It displays the contents of your truck bed. The camera contains a dynamic guideline to help locate the center of your vehicle. This view can be accessed while in drive (D) or reverse (R).

### Auxiliary Camera

The auxiliary camera is a variant of the rear view camera and is accessed by pressing the AUX button on the display screen when moving in reverse (R) or in drive (D). It displays a rear view image from the back of a trailer while in reverse.

## 360 DEGREE CAMERA GUIDE LINES

**Note:** Active guide lines are only available when the transmission is in reverse (R).

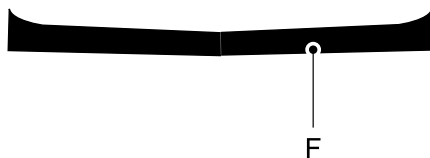
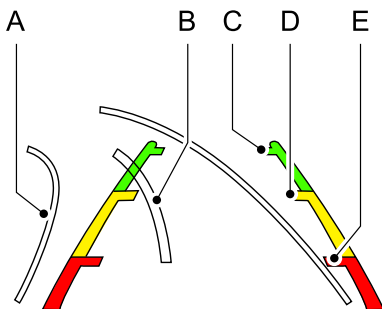

- A Active guide lines.
- B Centerline.
- C Fixed guide line: Green zone.
- D Fixed guide line: Yellow zone.
- E Fixed guide line: Red zone.
- F Rear bumper.

Active guide lines only show with fixed guide lines. Turn the steering wheel to point the guide lines toward an intended path. If the steering wheel position changes when reversing, your vehicle could deviate from the intended path.

The fixed and active guide lines fade in and out depending on the steering wheel position. The active guide lines do not display when the steering wheel position is straight.

## 360 Degree Camera (If Equipped)

Objects in the red zone are closest to your vehicle and objects in the green zone are farther away. Objects get closer to your vehicle as they move from the green zone to the yellow or red zones. Use the side view mirrors and rear view mirror to get better coverage on both sides and rear of your vehicle.

### Keep Out Zone

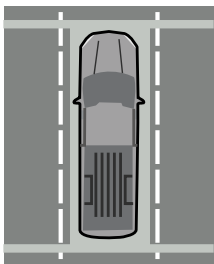

The keep out zone is represented by the yellow dotted lines running parallel to your vehicle.

### 360 DEGREE CAMERA SETTINGS

#### SWITCHING THE 360 DEGREE CAMERA ON AND OFF - VEHICLES WITH: 12.3 INCH SCREEN



The 360 degree camera system button is on the instrument panel. The front and rear cameras have multiple screens which consist of:

- Normal view.
- Normal view with 360.
- Split view.
- Bed camera.

- Auxiliary camera.
- Hitch view.

**Note:** *The rear view camera activates when you switch into reverse (R). Additional views are then accessible on the touchscreen.*

When in park (P), neutral (N) or drive (D), the front images display when the button is pressed. When in reverse (R), only the rear images display when the button is pressed.

**Note:** *Not all cameras are available.*

**Note:** *The 360 degree camera system turns off when your vehicle is in motion at low speed, except when in reverse (R).*

#### SWITCHING THE 360 DEGREE CAMERA ON AND OFF - VEHICLES WITH: 15 INCH SCREEN

1. Access the vehicle drawer on the touchscreen.
2. Press **CONTROLS**.
3. Press camera.

**Note:** *When the camera button is pressed, the front 360 camera view is shown as default and other front camera views are accessed from the screen.*

**Note:** *The rear view camera activates when you switch into reverse (R).*

The following camera views can be changed on the touchscreen:

- Normal view.
- Normal view with 360.
- Split view.

When in park (P), neutral (N) or drive (D), only the front images display when the button is pressed.

**Note:** *The 360 degree camera system turns off when your vehicle is traveling at low speed, except when in reverse (R).*

## 360 Degree Camera (If Equipped)

### SWITCHING THE 360 DEGREE CAMERA VIEW



Press to access the different camera views.



Front normal view provides an image of what is directly in front of your vehicle.



Front split view provides an extended view of what is in front of your vehicle.



Normal + 360 degree view contains the normal camera view next to a 360 degree camera view.



Rear normal view provides an image of what is directly behind your vehicle.



Rear split view provides an extended view of what is behind your vehicle.



Bed camera shows the truck bed.



Trailer AUX camera shows a rear view camera image of what is behind your trailer. This camera needs to be purchased and installed separately.



The hitch view provides an image of the area around the tow hitch.



Trailer reverse guidance shows the sides of your truck and trailer. See **Trailer Reversing Aid** (page 363).



Zooms in on the image and park hold is activated. See **Connecting a Trailer** (page 348).



Zooms in on the 360 degree image.

**Note:** *The rear normal view, bed camera view, hitch view and trailer auxiliary view are available when your vehicle speed is greater than 6 mph (10 km/h).*

# Active Park Assist

## WHAT IS ACTIVE PARK ASSIST

Assists you with parking in and out of parking spaces.

## HOW DOES ACTIVE PARK ASSIST WORK

Active park assist uses sensors to detect parking spaces. The system steers, accelerates, brakes and shifts gears as necessary to maneuver into or out of a parking space.

## ACTIVE PARK ASSIST PRECAUTIONS



**WARNING:** You must remain in your vehicle when the system turns on. At all times, you are responsible for controlling your vehicle, supervising the system and intervening, if required. Failure to take care may result in the loss of control of your vehicle, serious personal injury or death.



**WARNING:** The sensors may not detect objects in heavy rain or other conditions that cause interference.



**WARNING:** You are responsible for controlling your vehicle at all times. The system is designed to be an aid and does not relieve you of your responsibility to drive with due care and attention. Failure to follow this instruction could result in the loss of control of your vehicle, personal injury or death.



**WARNING:** Do not use the system with accessories that extend beyond the front or rear of your vehicle, for example a trailer hitch or bike rack. The system is not able to make corrections for the additional length of the accessories.

## SWITCHING ACTIVE PARK ASSIST ON AND OFF



Press the parking aid button, then press the active park assist icon on the touchscreen to bring up full screen notifications.

Press the soft keys on the touchscreen to switch between the parallel park in, perpendicular park in, or parallel park out parking modes.

## Cancelling Active Park Assist

To cancel parking assistance at any time, shift out of neutral (N).

## Pausing Active Park Assist

To pause parking assistance at any time, release the parking aid button.

If you open the passenger or rear doors, active park assist pauses.

To resume parking, press and hold the parking aid button again.

## ENTERING A PARALLEL PARKING SPACE

1. Press the parking aid button.

**Note:** *The system detects other vehicles and curbs to find a parking space.*

2. Press the active park assist icon on the touchscreen.

## Active Park Assist

3. Use the turn signal lever to search for a parking space on the driver or passenger side of your vehicle.

**Note:** *If you do not use the turn signal lever, the system searches for a parking space on the passenger side of your vehicle.*

4. Drive your vehicle approximately 3 ft (1 m) away from and parallel to the other parked vehicles when searching for a parking space.

**Note:** *A tone sounds and a message appears in the information and entertainment display when active park assist finds a suitable parking space.*

5. Press and hold the brake pedal.
6. Release the steering wheel and shift into neutral (N).
7. Press and hold the parking aid button.
8. Release the brake pedal to allow your vehicle to park.

**Note:** *You can slow down your vehicle at any time by pressing the brake pedal.*

**Note:** *When parallel parking between objects, the system parks closer to the object in front of your vehicle to allow easier access to the luggage compartment.*

**Note:** *When parking is complete, your vehicle shifts into park (P).*

### ENTERING A PERPENDICULAR PARKING SPACE

1. Press the parking aid button.

**Note:** *Active park assist does not recognize parking space lines and centers your vehicle between objects.*

2. Press the active park assist icon on the touchscreen.
3. Select perpendicular parking.

4. Use the turn signal lever to search for a parking space on the driver or passenger side of your vehicle.

**Note:** *If you do not use the turn signal lever, the system searches for a parking space on the passenger side of your vehicle.*

5. Drive your vehicle approximately 3 ft (1 m) away from and perpendicular to the other parked vehicles when searching for a parking space.

**Note:** *A tone sounds and a message appears in the information and entertainment display when active park assist finds a parking space.*

6. Press and hold the brake pedal.
7. Release the steering wheel and shift into neutral (N).
8. Press and hold the parking aid button.
9. Release the brake pedal to allow the vehicle to park.

**Note:** *Active park assist backs your vehicle into parking spaces.*

**Note:** *Active park assist aligns the front end of your vehicle with the lane side of the object next to it.*

**Note:** *When the system detects only one object, it allows enough distance to open the door on either side.*

**Note:** *You can slow down your vehicle at any time by pressing the brake pedal.*

**Note:** *When parking is complete, your vehicle shifts into park (P).*

### EXITING A PARKING SPACE

Active park assist only assists leaving parallel parking spaces.

1. Press the parking aid button.
2. Press the active park assist icon on the touchscreen.
3. Select parallel park exit.



# Active Park Assist

4. Use the turn signal to choose the direction to exit the parking space.
5. Press and hold the brake pedal.
6. Release the steering wheel and shift into neutral (N).
7. Release the parking brake.
8. Press and hold the parking aid button.
9. Release the brake pedal to allow your vehicle to move.

**Note:** After active park assist drives your vehicle to a position where you can exit the parking space in a forward movement, a message appears instructing you to take full control of your vehicle.

10. Take control of your vehicle.

**Note:** You can slow down your vehicle at any time by pressing the brake pedal.

## ACTIVE PARK ASSIST – TROUBLESHOOTING

### ACTIVE PARK ASSIST – INFORMATION MESSAGES

Message	Action
Active Park Fault	The system requires service. Have your vehicle checked as soon as possible.

### ACTIVE PARK ASSIST – FREQUENTLY ASKED QUESTIONS

#### Why does active park assist not operate correctly?

The system is unable to detect a vehicle, curb or object to park next to or in between. The system needs boundary objects to operate correctly.

#### Why does active park assist not search for a parking space?

You have switched traction control off.

#### Why does active park assist not search for a parking space?

The transmission is in reverse (R). Your vehicle must be moving forward to be able to detect a parking space.

#### Why does active park assist not offer a parking space?

The sensors could be blocked. For example, snow, ice or large accumulations of dirt. Blocked sensors can affect how the system functions.

#### Why does active park assist not offer a parking space?

The sensors in the front or rear bumper could be damaged.

#### Why does active park assist not offer a parking space?

There is not enough room in the parking space for your vehicle to safely park.

#### Why does active park assist not offer a parking space?

There is not enough space for the parking maneuver on the opposite side of the parking space.

#### Why does active park assist not offer a parking space?

The parking space is more than 5 ft (1.5 m) or less than 2 ft (0.5 m) away from your vehicle.

#### Why does active park assist not offer a parking space?

Your vehicle's speed is greater than 22 mph (35 km/h) for parallel parking or greater than 19 mph (30 km/h) for perpendicular parking.

# Active Park Assist

---

## **Why does active park assist not offer a parking space?**

You recently disconnected or replaced the battery. After you reconnect the battery you must drive your vehicle on a straight road for a short period of time.

## **Why does active park assist not correctly position the vehicle into a parking space?**

An irregular curb along the parking space prevents the system from correctly aligning your vehicle.

## **Why does active park assist not correctly position the vehicle into a parking space?**

Vehicles or objects bordering the space could not be correctly parked.

## **Why does active park assist not correctly position the vehicle into a parking space?**

Your vehicle stopped too far past the parking space.

## **Why does active park assist not correctly position the vehicle into a parking space?**

The tires are not correctly installed or maintained. For example, using a spare tire, not inflated correctly, improper size, or of different sizes.

## **Why does active park assist not correctly position the vehicle into a parking space?**

A repair or alteration changed the detection capabilities.

## **Why does active park assist not correctly position the vehicle into a parking space?**

A parked vehicle has a high attachment. For example, a salt sprayer, snowplow or moving truck bed.

## **Why does active park assist not correctly position the vehicle into a parking space?**

The parking space length, or position of parked objects, changes after your vehicle passes the space.

## **Why does active park assist not correctly position the vehicle into a parking space?**

The temperature around your vehicle quickly changes. For example, driving from a heated garage into a cold outside temperature, or after leaving a car wash.

# Cruise Control

## WHAT IS CRUISE CONTROL

Cruise control lets you maintain a set speed without keeping your foot on the accelerator pedal.

### Requirements

Use cruise control when the vehicle speed is greater than 15 mph in imperial units and 20 km/h in metric units.

## SWITCHING CRUISE CONTROL ON AND OFF



**WARNING:** Do not use cruise control on winding roads, in heavy traffic or when the road surface is slippery. This could result in loss of vehicle control, serious injury or death.

The cruise controls are on the steering wheel.

### Switching Cruise Control On



Press the button to activate the system. When the system activates, the set speed is equal to whichever is greater, the current vehicle speed, or 15 mph when in imperial units or 20 km/h when in metric units. If the speed is too low, or other conditions are not correct for cruise control activation, the system enters standby mode.

### Switching Cruise Control Off



Press the button when the system is active or switch the ignition off.

**Note:** When you switch cruise control off, the set speed clears.

## SETTING THE CRUISE CONTROL SPEED



**WARNING:** When you are going downhill, your vehicle speed could increase above the set speed. The system does not apply the brakes.

Drive to the speed you prefer.

**SET+**

Press either the SET+ or SET- buttons to set the current speed.

**SET-**

Take your foot off the accelerator pedal.

**Note:** The indicator changes color in the information display.

### Changing the Set Speed

**SET+**

Press the SET+ button to increase the set speed in small increments. Press and hold the SET+ button to accelerate. Release the button when you have reached your preferred speed.

**SET-**

Press the SET- button to decrease the set speed in small increments. Press and hold the SET- button to decelerate. Release the button when you have reached your preferred speed.

**Note:** If you accelerate by pressing the accelerator pedal, the set speed does not change. When you release the accelerator pedal, your vehicle returns to the speed that you previously set.

# Cruise Control

---

## CANCELING THE SET SPEED



Press the button, or tap the brake pedal to cancel the set speed.

**Note:** *The system remembers the set speed.*

**Note:** *The system cancels if the vehicle speed drops below 10 mph (16 km/h) under the set speed when driving uphill.*

## RESUMING THE SET SPEED



Press the button.

## CRUISE CONTROL INDICATORS



Illuminates when you switch the system on.

# Adaptive Cruise Control (If Equipped)

## HOW DOES ADAPTIVE CRUISE CONTROL WITH STOP AND GO WORK

Adaptive cruise control with stop and go uses radar and camera sensors to maintain a set gap between your vehicle and the vehicle in front of you while following it to a complete stop. Stop and go can also be set to follow a vehicle directly in front of you and adjust the set speed, while you are at a complete stop.

## ADAPTIVE CRUISE CONTROL PRECAUTIONS



**WARNING:** You are responsible for controlling your vehicle at all times. The system is designed to be an aid and does not relieve you of your responsibility to drive with due care and attention. Failure to follow this instruction could result in the loss of control of your vehicle, personal injury or death.



**WARNING:** Do not use adaptive cruise control on winding roads, in heavy traffic or when the road surface is slippery. This could result in loss of vehicle control, serious injury or death.



**WARNING:** Pay close attention to changing road conditions such as entering or leaving a highway, on roads with intersections or roundabouts, roads without visible lanes of travel, roads that are unpaved, or steep slopes. Failure to follow this instruction could result in the loss of control of your vehicle, personal injury or death.



**WARNING:** The system is not a crash warning or avoidance system.



**WARNING:** Do not use the system when towing a trailer that has aftermarket electronic trailer brake controls. Failure to follow this instruction could result in the loss of control of your vehicle, personal injury or death.



**WARNING:** Do not use tire sizes other than those recommended because this can affect the normal operation of the system. Failure to do so may result in a loss of vehicle control, which could result in serious injury.



**WARNING:** Do not use the system with a snow plow blade installed.



**WARNING:** Do not use the system in poor visibility, for example fog, heavy rain, spray or snow.

## When Following a Vehicle



**WARNING:** When following a vehicle that is braking, your vehicle does not always decelerate quickly enough to avoid a crash without driver intervention. Apply the brakes when necessary. Failure to follow this instruction could result in personal injury or death.

## Hilly Condition Usage

Select a lower gear when the system is active in situations such as prolonged downhill driving on steep slopes, for example in mountainous areas.

# Adaptive Cruise Control (If Equipped)

## ADAPTIVE CRUISE CONTROL LIMITATIONS

### Sensor Limitations

**WARNING:** On rare occasions, detection issues can occur due to the road infrastructures, for example bridges, tunnels and safety barriers. In these cases, the system may brake late or unexpectedly. At all times, you are responsible for controlling your vehicle, supervising the system and intervening, if required.

**WARNING:** If the system malfunctions, have your vehicle checked as soon as possible.

**WARNING:** Large contrasts in outside lighting can limit sensor performance.

**WARNING:** The system only warns of vehicles detected by the radar sensor. In some cases there may be no warning or a delayed warning. Apply the brakes when necessary. Failure to follow this instruction could result in personal injury or death.

**WARNING:** The system may not detect stationary or slow moving vehicles below 6 mph (10 km/h).

**WARNING:** The system does not detect pedestrians or objects in the road.

**WARNING:** The system does not detect oncoming vehicles in the same lane.

**WARNING:** The system may not operate properly if the sensor is blocked. Keep the windshield free from obstruction.

**WARNING:** The sensor may incorrectly track lane markings as other structures or objects. This can result in a false or missed warning.

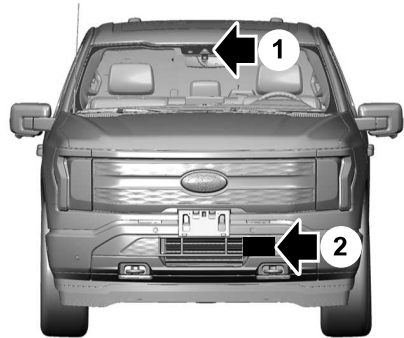

1. Camera.
2. Radar sensor.

The camera is on the windshield behind the interior mirror.

The radar sensor is in the lower grille.

**Note:** You cannot see the sensor. It is behind a fascia panel.

**Note:** Keep the front of your vehicle free of dirt, metal badges or objects. Vehicle front protectors, aftermarket lights, additional paint or plastic coatings could also degrade sensor performance.

A message displays if something obstructs the camera or the sensor. When something blocks the sensor, the system cannot detect a vehicle ahead and does not function. See **Adaptive Cruise Control – Information Messages** (page 285).

# Adaptive Cruise Control (If Equipped)

The radar sensor has a limited field of view. It may not detect vehicles at all or detect a vehicle later than expected in some situations. The lead vehicle image does not illuminate if the system does not detect a vehicle in front of you.

## Detection Issues Can Occur:

A

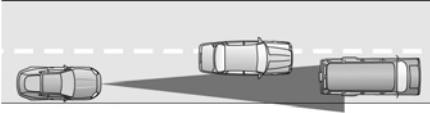

B

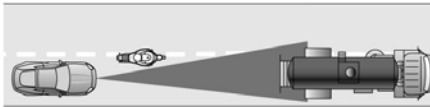

C

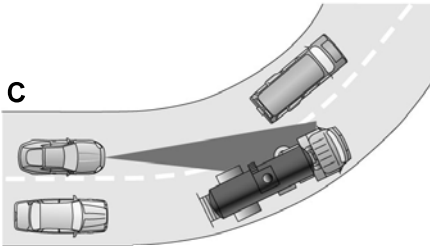

- A When driving on a different line than the vehicle in front.
- B With vehicles that edge into your lane. The system can only detect these vehicles once they move fully into your lane.
- C There may be issues with the detection of vehicles in front when driving into and coming out of a bend or curve in the road.

In these cases, the system may brake late or unexpectedly.

If something hits the front end of your vehicle or damage occurs, the radar-sensing zone may change. This could cause missed or false vehicle detection.

Optimal system performance requires a clear view of the road by the windshield camera.

Optimal performance may not occur if:

- The camera is blocked.
- There is poor visibility or lighting conditions.
- There are bad weather conditions.

## SWITCHING ADAPTIVE CRUISE CONTROL ON AND OFF

The cruise controls are on the steering wheel.

### Switching Adaptive Cruise Control On



Press the button to activate the system. When the system activates, the set speed is equal to whichever is greater, the current vehicle speed, or 15 mph when in imperial units or 20 km/h when in metric units. If the speed is too low, or other conditions are not correct for adaptive cruise control activation, the system enters standby mode. When you are below 15 mph when in imperial units or 20 km/h when in metric units, adaptive cruise control does not activate unless you are following another vehicle.

The indicator, current gap setting and set speed appear in the instrument cluster display.

# Adaptive Cruise Control (If Equipped)

## Switching Adaptive Cruise Control Off



Press the button when the system is in standby mode or switch the ignition off.

**Note:** When you switch the system off, the set speed clears.

## ADAPTIVE CRUISE CONTROL AUTOMATIC CANCELLATION

The system may cancel if:

- The tires lose traction.
- You apply the parking brake.

The system may cancel and set the parking brake if:

- You unbuckle the seatbelt and open the driver door after adaptive cruise control stops your vehicle.
- Adaptive cruise control holds your vehicle at a stop continuously for more than three minutes.

The system may deactivate or prevent activating when requested if:

- The vehicle has a blocked sensor.
- The brake temperature is too high.
- There is a failure in the system or a related system.

## SETTING THE ADAPTIVE CRUISE CONTROL SPEED

Drive to the speed you prefer.



Press the SET+ or SET- buttons to set the current speed.



Take your foot off the accelerator pedal.

The indicator, current gap setting and set speed appear in the instrument cluster display.



A vehicle image illuminates if there is a vehicle detected in front of you.

**Note:** When adaptive cruise control is active, the speedometer may vary slightly from the set speed displayed in the instrument cluster display.

## Setting the Adaptive Cruise Speed from a Complete Stop



Press the SET+ or SET- buttons while keeping the brake pedal fully pressed.



The set speed adjusts to 20 km/h when in metric units or 15 mph when in imperial units.

The indicator, current gap setting and set speed appear in the instrument cluster display.

**Note:** The system activates from a complete stop only when it detects a lead vehicle in close proximity.



# Adaptive Cruise Control (If Equipped)

## Manually Changing the Set Speed

**SET+** Press the SET+ button to increase the set speed in small increments. Press and hold the SET+ button to increase the set speed in large increments. Release the button when the indicated set speed reaches the preferred speed.

**SET-** Press the SET- button to decrease the set speed in small increments. Press and hold the SET- button to decrease the set speed in large increments. Release the button when the indicated set speed reaches the preferred speed.

You can also press the accelerator or brake pedal until you reach the speed you prefer. Press the SET+ or SET- button to select the current speed as the set speed.

The system may apply the brakes to slow the vehicle to the new set speed. The set speed continuously displays in the instrument cluster display when the system is active.

## SETTING THE ADAPTIVE CRUISE CONTROL GAP

 Press the button to cycle through the four gap settings.

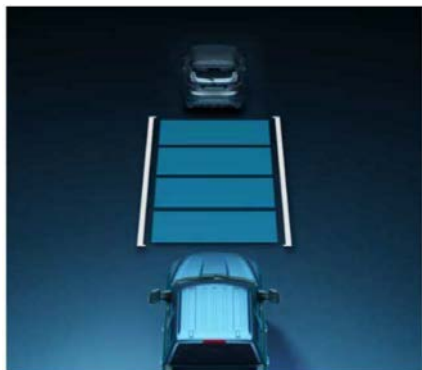

The selected gap appears in the information display as shown by the bars in the image.

**Note:** *The gap setting is time dependent and therefore, the distance adjusts with your vehicle speed.*

**Note:** *It is your responsibility to select a gap appropriate to the driving conditions.*

## Adaptive Cruise Control Gap Settings

Graphic Display, Bars Indicated Between Vehicles	Gap Distance	Dynamic Behavior
1	Closest.	Sport.
2	Close.	Normal.
3	Medium.	Normal.
4	Far.	Comfort.

Each time you switch the system on, it selects the last chosen gap setting.

# Adaptive Cruise Control (If Equipped)

## Following a Vehicle

When a vehicle ahead of you enters the same lane or a slower vehicle is ahead in the same lane, the vehicle speed adjusts to maintain the gap setting.

**Note:** *When you are following a vehicle and you switch on a turn signal lamp, adaptive cruise control may provide a small, temporary acceleration to help you pass.*

Your vehicle maintains a consistent gap from the vehicle ahead until:

- The vehicle in front of you accelerates to a speed above the set speed.
- The vehicle in front of you moves out of the lane you are in.
- You set a new gap distance.

The system applies the brakes to slow down your vehicle to maintain a safe gap distance from the vehicle in front of you. The system only applies limited braking. You can override the system by applying the brakes.

**Note:** *The brakes may emit noise when applied by the system.*

If the system determines that its maximum braking level is not sufficient, an audible warning sounds, a message appears in the information display and an indicator flashes when the system continues to brake. Take immediate action.

## CANCELING THE SET SPEED



Press the button or tap the brake pedal.

The set speed does not erase.

## RESUMING THE SET SPEED



Press the button.

Your vehicle speed returns to the previously set speed and gap setting. The set speed displays continuously in the information display when the system is active.

**Note:** *Only use resume if you are aware of the set speed and intend to return to it.*

## Resuming the Set Speed from a Complete Stop (If Equipped)

If your vehicle follows a vehicle to a complete stop and remains stationary for less than a few seconds, your vehicle accelerates from a stationary position to follow the vehicle ahead.

If your vehicle follows a vehicle to a complete stop and remains stationary for more than a few seconds, an indicator and message displays.



## Adaptive Cruise Control (If Equipped)

Message	Action
Stopped	Cruise control does not resume automatically when this display is active.
Press button to resume	If the lead vehicle begins to move, you are prompted to press the resume button. Press and release the button or use the accelerator pedal to resume following the lead vehicle.
Auto-Resume	Displays when on a limited access highway after following a vehicle to a complete stop. In this situation, the vehicle resumes following the lead vehicle without a button press or pressing the accelerator pedal. The system can remain in auto-resume state for approximately 30 seconds, after which it no longer automatically resumes.

### OVERRIDING THE SET SPEED

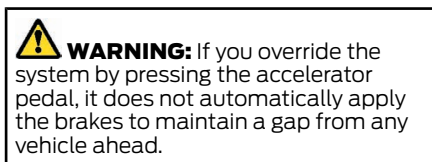

When you press the accelerator pedal, you override the set speed and gap distance.

Use the accelerator pedal to intentionally exceed the set speed limit.

When you override the system, the green indicator illuminates and the vehicle icon does not appear in the instrument cluster display.

The system resumes operation when you release the accelerator pedal. The vehicle speed decreases to the set speed, or a lower speed if following a slower vehicle.

### ADAPTIVE CRUISE CONTROL INDICATORS



Illuminates when you switch adaptive cruise control on. The color of the indicator changes to indicate the system status.

White indicates the system is on but inactive.

Green indicates that you set the speed and the system is active.

## Adaptive Cruise Control (If Equipped)

### SWITCHING FROM ADAPTIVE CRUISE CONTROL TO CRUISE CONTROL - VEHICLES WITH: 12.3 INCH SCREEN



**WARNING:** Normal cruise control will not brake when your vehicle is approaching slower vehicles. Always be aware of which mode you have selected and apply the brakes when necessary.

1. Press **Features** on the touchscreen.
2. Press **Driver Assistance**.
3. Press **Cruise Control**.
4. Press **Normal Cruise Control**.



The cruise control indicator replaces the adaptive cruise control indicator if you select normal cruise control. The gap setting does not display, and the system does not respond to lead vehicles. Automatic braking remains active to maintain set speed. The system remembers the last setting when you start your vehicle.

### SWITCHING FROM ADAPTIVE CRUISE CONTROL TO CRUISE CONTROL - VEHICLES WITH: 15 INCH SCREEN



**WARNING:** Normal cruise control will not brake when your vehicle is approaching slower vehicles. Always be aware of which mode you have selected and apply the brakes when necessary.

1. Access the vehicle drawer on the touchscreen.
2. Press **Driver Assistance**.

3. Press **Cruise Control**.
4. Press **Normal Cruise Control**.



The cruise control indicator replaces the adaptive cruise control indicator if you select normal cruise control. The gap setting does not display, and the system does not respond to lead vehicles. Automatic braking remains active to maintain set speed. The system remembers the last setting when you start your vehicle.

## LANE CENTERING

### HOW DOES LANE CENTERING WORK

Adaptive cruise control with lane centering uses radar and camera sensors to help keep your vehicle in the middle of the lane by applying continuous assistance steering torque input toward the lane center on highways.

**Note:** *The adaptive cruise control gap setting operates normally.*

If you drive off-center within the lane, the system sets and maintains that preferred lane position. The system provides continuous assistance steering torque input toward the preferred position.

**Note:** *The system can only set preferred lane positions within the lane.*

**Note:** *If the system cancels, the preferred position erases. On the next activation, the system provides continuous assistance steering torque input toward the lane center.*

# Adaptive Cruise Control (If Equipped)

## LANE CENTERING PRECAUTIONS



**WARNING:** Do not use the system when towing a trailer. Failure to follow this instruction could result in the loss of control of your vehicle, personal injury or death.



**WARNING:** Do not use the system if any changes or modifications to the steering wheel have been made. Any changes or modifications to the steering wheel could affect the functionality or performance of the system. Failure to follow this instruction could result in the loss of control of your vehicle, personal injury or death.

Adaptive cruise control precautions apply to lane centering unless stated otherwise or contradicted by a lane centering precaution. See **Adaptive Cruise Control Precautions** (page 273).

## LANE CENTERING REQUIREMENTS

You must keep your hands on the steering wheel at all times.

The system only activates when all of the following occur:

- You have adaptive cruise control with stop and go on.
- Lane centering assist is enabled in your information and entertainment screen. See **Switching Lane Centering On and Off** (page 281).
- You have your hands on the steering wheel.
- The system detects both lane markings.

**Note:** *If it does not detect valid lane markings, the system stays inactive until valid markings are available.*

## LANE CENTERING LIMITATIONS

Adaptive cruise control limitations apply to lane centering unless stated otherwise or contradicted by a lane centering limitation. See **Adaptive Cruise Control Limitations** (page 274).

Lane Centering may not correctly operate in any of the following conditions:

- The lane is too narrow or wide.
- The system does not detect at least one lane marking or when lanes merge or split.
- Limited steering torque input is applied.
- Areas under construction or new infrastructure.
- When modifications to the steering system have been made.
- When using a spare tire.
- In high wind conditions.

**Note:** *The driving assistance torque is limited and may not be sufficient for all driving situations such as driving through tight curves or driving through curves at high speeds.*

**Note:** *In exceptional conditions, such as inclement weather or direct sunlight, the system could deviate from the center line or could cancel.*

## SWITCHING LANE CENTERING ON AND OFF - VEHICLES WITH: 12.3 INCH SCREEN

You must keep your hands on the steering wheel at all times.

The controls are on the steering wheel.



Press the button.

# Adaptive Cruise Control (If Equipped)

The indicator appears in the information display. When the system is on, the color of the indicator changes to indicate the system status.

You can override the system at any time by steering your vehicle.

**Note:** *The correct requirements must be met before you can switch the system on. See **Lane Centering Requirements** (page 281).*

## Enabling and Disabling Lane Centering

1. Press **Features** on the touchscreen.
2. Press **Driver Assistance**.
3. Press **Cruise Control**.
4. Press **Lane Centering Assist**.

## SWITCHING LANE CENTERING ON AND OFF - VEHICLES WITH: 15 INCH SCREEN

You must keep your hands on the steering wheel at all times.

The controls are on the steering wheel.



Press the button.

The indicator appears in the information display. When the system is on, the color of the indicator changes to indicate the system status.

You can override the system at any time by steering your vehicle.

**Note:** *The correct requirements must be met before you can switch the system on. See **Lane Centering Requirements** (page 281).*

## Enabling and Disabling Lane Centering

1. Access the vehicle drawer on the touchscreen.
2. Press **Settings**.
3. Press **Driver Assistance**.
4. Press **Cruise Control**.
5. Press **Lane Centering Assist**.

## LANE CENTERING ALERTS

You must keep your hands on the steering wheel at all times.

When the system is active and detects no steering activity for a period of time, the system alerts you to put your hands on the steering wheel. If you do not react to the warnings the system cancels and slows your vehicle down to idle speeds while maintaining steering control. See **Lane Centering Automatic Cancellation** (page 282).

The system also alerts you if your vehicle crosses lane markings without detected steering activity.

**Note:** *The system could detect a light grip or touch on the steering wheel as hands-off driving.*

## LANE CENTERING AUTOMATIC CANCELLATION

When an external condition cancels the system, for example, no lane line markings available, a tone sounds and a message appears in the instrument cluster display.



If your vehicle starts to slow down after system cancellation, you must take full control of the vehicle. To re-enable adaptive cruise control with lane centering after cancellation, press and release the resume button.

# Adaptive Cruise Control (If Equipped)

Automatic cancellation can also occur if:

- The lane becomes too wide or narrow.
- The system cannot detect valid lane markings.
- Lane markings cross over one another.
- The curve of the road is too sharp.

**Note:** *If your vehicle slows down due to your inactivity twice within a key cycle, the system disables. To reset the system, when the vehicle is stationary, return the gear selector to park (P) and turn the vehicle off. Then, restart the vehicle with your foot on the brake pedal.*

## LANE CENTERING INDICATORS



Illuminates when you switch lane centering on. The color of the indicator changes to indicate the system status.

Gray status indicates the system is on but in standby mode.

Green status indicates the system is enabled and applying steering assistance to keep the vehicle in the center of the lane.

Amber status with an audible tone, that then changes to gray status, indicates a system automatic cancellation.

## INTELLIGENT ADAPTIVE CRUISE CONTROL

### HOW DOES INTELLIGENT ADAPTIVE CRUISE CONTROL WORK

Intelligent adaptive cruise control combines speed sign recognition and navigation map data with adaptive cruise control to adjust the cruise set speed to the speed limit detected by the speed sign recognition system. As the system detects new speed signs, the set speed updates.

There are limitations that affect the accuracy of the speed sign recognition system and its ability to determine the current speed limit. The intelligent adaptive cruise control system and its ability to determine the current speed limit shares these limitations. See **Speed Sign Recognition** (page 324).

**Note:** *The adaptive cruise control gap setting operates normally when the feature is enabled.*

## INTELLIGENT ADAPTIVE CRUISE CONTROL PRECAUTIONS



**WARNING:** You are responsible for controlling your vehicle at all times. The system is designed to be an aid and does not relieve you of your responsibility to drive with due care and attention. Failure to follow this instruction could result in the loss of control of your vehicle, personal injury or death.

## INTELLIGENT ADAPTIVE CRUISE CONTROL REQUIREMENTS

Traffic sign recognition must be enabled for intelligent adaptive cruise control to be active.

## INTELLIGENT ADAPTIVE CRUISE CONTROL LIMITATIONS

The speed limit information provided by the navigation map data could be inaccurate or out of date.

The system may not detect and read speed limit signs with conditional information, for example, when a sign is flashing, during specific time ranges, or when children are present.

## Adaptive Cruise Control (If Equipped)

**Note:** The system does not set the vehicle speed to speed limits shown with a supplementary traffic sign.

Under certain conditions, the system may not adjust the vehicle speed until after your vehicle passes the speed limit.

### SWITCHING INTELLIGENT MODE ON AND OFF - VEHICLES WITH: 12.3 INCH SCREEN

1. Press **Features** on the touchscreen.
2. Press **Driver Assistance**.
3. Press **Cruise Control**.
4. Press **Adaptive Cruise Control**.
5. Press **Speed Sign Recognition**.

### SWITCHING INTELLIGENT MODE ON AND OFF - VEHICLES WITH: 15 INCH SCREEN

1. Access the vehicle drawer on the touchscreen.
2. Press **SETTINGS**.
3. Press **Driver Assistance**.
4. Press **Cruise Control**.
5. Press **Speed Sign Recognition**.

### ADJUSTING THE SET SPEED TOLERANCE - VEHICLES WITH: 12.3 INCH SCREEN

1. Press **Features** on the touchscreen.
2. Press **Driver Assistance**.
3. Press **Cruise Control**.
4. Press **Adaptive Cruise Control**.
5. Press **Speed Sign Recognition**.
6. Press **Tolerance**.
7. Use **+** and **-** to set the tolerance.

**Note:** You cannot set the tolerance more than 20 mph (30 km/h) above or below the recognized speed.

### ADJUSTING THE SET SPEED TOLERANCE - VEHICLES WITH: 15 INCH SCREEN

1. Access the vehicle drawer on the touchscreen
2. Press **SETTINGS**.
3. Press **Driver Assistance**.
4. Press **Cruise Control**.
5. Press **Adaptive Cruise Control**.
6. Press **Speed Sign Recognition**.
7. Press **Tolerance**.
8. Use **+** and **-** to set the tolerance.

**Note:** You cannot set the tolerance more than 20 mph (30 km/h) above or below the recognized speed.

### INTELLIGENT ADAPTIVE CRUISE CONTROL ALERTS

If you increase the set speed beyond the speed limit or speed limit plus a positive tolerance value, the set speed indicator flashes.

The warning does not occur if:

- You override the set speed using the accelerator pedal.
- The vehicle speed exceeds the set speed due to being on a downhill slope.



## Adaptive Cruise Control (If Equipped)

### INTELLIGENT ADAPTIVE CRUISE CONTROL INDICATORS - VEHICLES WITH: 12.3 INCH SCREEN



The set speed limit displays next to the detected speed limit in the instrument cluster.

### INTELLIGENT ADAPTIVE CRUISE CONTROL INDICATORS - VEHICLES WITH: 15 INCH SCREEN



The set speed limit displays next to the detected speed limit in the instrument cluster.

## ADAPTIVE CRUISE CONTROL – TROUBLESHOOTING

### ADAPTIVE CRUISE CONTROL – INFORMATION MESSAGES - VEHICLES WITH: LANE CENTERING

**Note:** Depending on your vehicle options and instrument cluster type, not all messages display or are available.

**Note:** The system could abbreviate or shorten certain messages depending upon which cluster type you have.

## Adaptive Cruise Control (If Equipped)

---

<b>Message</b>	<b>Action</b>
Keep Hands on Steering Wheel	Return your hands to the steering wheel and provide steering input to cancel the message.
Lane Centering Assist Not Available	To reset the feature when the vehicle is stationary, return the gear selector to park and turn the vehicle off. Restart the vehicle with your foot on the brake pedal.
Resume Control	You must immediately take full control of the vehicle.
Press Accelerator Pedal to Resume	Resume adaptive cruise control with lane centering by applying foot pressure on the accelerator pedal. You can also resume the feature by pressing the resume button on the steering wheel.

## Adaptive Cruise Control (If Equipped)

### ADAPTIVE CRUISE CONTROL – INFORMATION MESSAGES - VEHICLES WITH: STOP AND GO

**Note:** Depending on your vehicle options and instrument cluster type, not all messages display or are available.

**Note:** The system could abbreviate or shorten certain messages depending upon which cluster type you have.

Message	Action
Adaptive Cruise Malfunction	A malfunction is preventing the adaptive cruise from engaging.
Front Sensor Not Aligned	Contact an authorized dealer to have the radar checked for proper coverage and operation.
Adaptive Cruise Not Available	Conditions exist preventing the system from being available.
Adaptive Cruise Not Available Sensor Blocked See Manual	You have a blocked radar because of poor radar visibility due to inclement weather or ice, mud, or water in front of the radar. You can typically clean the sensor to resolve this. Due to the nature of radar technology, it is possible to get a blockage warning with no actual block. This happens, for example, when driving in sparse rural or desert environments. A false blocked condition either self clears, or clears after you restart your vehicle.
Normal Cruise Active Adaptive Braking Off	You have selected normal cruise control. The system does not brake or react to traffic.
Adaptive Cruise - Driver Resume Control	Displays when the adaptive cruise control is going to cancel and you must take control.
Adaptive Cruise Speed Too Low to Activate	Displays when the vehicle speed is too slow to activate the adaptive cruise control and there is no lead vehicle in range.

## BlueCruise (If Equipped)

### WHAT IS BLUECRUISE

BlueCruise keeps your vehicle centered in the lane and offers a hands-free driving mode in certain situations when using adaptive cruise control.

### HOW DOES BLUECRUISE WORK

BlueCruise uses cameras to monitor your vehicle position within a lane and applies steering support to keep your vehicle centered in the lane.

Using the cameras and location information, BlueCruise allows you to remove your hands from the steering wheel and offers a hands-free driving mode in certain areas.

When active, BlueCruise uses a driver facing camera and infrared lighting to monitor your eyes and head position to detect if you are distracted. If the system determines you are distracted, it alerts you to return your eyes to the road.

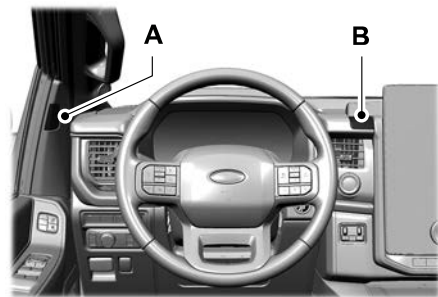

- A Lighting area.
- B Camera.

**Note:** When BlueCruise is active, in certain crash or near crash-like situations, such as an air bag deployment or hitting a road obstacle, camera data may record through the vehicle event data recorder. See **Event Data** (page 27).

**Note:** No data records under normal driving conditions.

### BLUECRUISE PRECAUTIONS

**WARNING:** You are responsible for keeping your eyes on the road at all times. The system is designed to be an aid and does not relieve you of your responsibility to drive with due care and attention. Failure to follow this instruction could result in the loss of control of your vehicle, personal injury or death.

**WARNING:** You are responsible for controlling your vehicle at all times. The system is designed to be an aid and does not relieve you of your responsibility to drive with due care and attention. Failure to follow this instruction could result in the loss of control of your vehicle, personal injury or death.

**WARNING:** Do not use the system when towing a trailer. Failure to follow this instruction could result in the loss of control of your vehicle, personal injury or death.

**WARNING:** Obstructions to the driver facing camera or infrared lighting could prevent the system from properly operating. Keep the camera and lighting areas free from obstruction. Failure to follow this instruction could result in the loss of control of your vehicle, personal injury or death.

## BlueCruise (If Equipped)

 **WARNING:** Do not use the system if any changes or modifications to the steering wheel have been made. Any changes or modifications to the steering wheel could affect the functionality or performance of the system. Failure to follow this instruction could result in the loss of control of your vehicle, personal injury or death.

 **WARNING:** The system may not function if the sensor is blocked.

 **WARNING:** Pay close attention to changing road conditions such as entering or leaving a highway, on roads with intersections or roundabouts, roads without visible lanes of travel, roads that are winding, slippery, unpaved, or steep slopes.

 **WARNING:** The system is not a crash warning or avoidance system.

 **WARNING:** Large contrasts in outside lighting can limit sensor performance.

 **WARNING:** The system attempts to keep your vehicle in the center of the lane as well as maintain speed and gap control. The system may not be able to perform these tasks in all situations. Do not use the system in complex or uncertain driving conditions. Failure to follow this instruction could result in the loss of control of your vehicle, personal injury or death.

 **WARNING:** Your vehicle could drift out of the lane of travel. Always be prepared to manually steer your vehicle. Failure to follow this instruction could result in the loss of control of your vehicle, personal injury or death.

 **WARNING:** The system will not operate if the sensor cannot track the road lane markings.

## BLUECRUISE REQUIREMENTS

BlueCruise only activates when all of the following occur:

- BlueCruise is enabled in your information and entertainment screen. See **BlueCruise Settings** (page 290).
- Adaptive cruise control is on.
- The system detects both lane markings.
- Your hands are on the steering wheel.
- Your eyes are on the road.

**Note:** *For hands-free mode to work, your vehicle must be on certain limited access divided freeways.*

**Note:** *The system may require updated software for hands-free mode. See **Vehicle System Updates** (page 554).*

## BLUECRUISE LIMITATIONS

Any of the following conditions could result in BlueCruise not correctly operating:

- You do not have your vehicle centered in the lane.
- The lane is too narrow or too wide.
- The system does not detect at least one lane marking or when lanes merge or split.
- You are applying a low amount of steering input.
- You are using the system in areas under construction.
- If you make any aftermarket modifications to the steering system.
- You are using a spare tire.

## BlueCruise (If Equipped)

The driver-facing camera may not operate correctly due to any of the following:

- You have a pre-existing eye condition, such as an eye misalignment, or have had eye surgery.
- You cover your facial features by a mask, hat or other items.
- The lighting conditions change significantly.
- You are not in the field of view of the camera.
- You position or tilt yourself to one side.
- You are moving around extensively.
- You are wearing glasses or sunglasses that are too dark or reflective.

**Note:** *The system has limited steering assistance and may not be sufficient for all driving situations.*

**Note:** *In exceptional conditions, such as inclement weather or direct sunlight, the system could deviate from the center line.*

**Note:** *The information provided by the navigation map data could be inaccurate or out of date.*

### BLUECRUISE SETTINGS - VEHICLES WITH: 12.3 INCH SCREEN

#### Enabling BlueCruise

1. Press **Features** on the touchscreen.
2. Press **Driver Assistance**.
3. Press **Cruise Control**.
4. Press **Lane Centering with Hands-Free**.

#### Enabling Activation Prompts

1. Press **Features** on the touchscreen.
2. Press **Driver Assistance**.
3. Press **Cruise Control**.

4. Press **Activation Prompts**.

### BLUECRUISE SETTINGS - VEHICLES WITH: 15 INCH SCREEN

#### Enabling BlueCruise

1. Access the vehicle drawer on the touchscreen.
2. Press **SETTINGS**.
3. Press **Driver Assistance**.
4. Press **Adaptive Cruise Control**.
5. Press **Lane Centering with Hands-Free**.

#### Enabling Activation Prompts

1. Access the vehicle drawer on the touchscreen.
2. Press **SETTINGS**.
3. Press **Driver Assistance**.
4. Press **Adaptive Cruise Control**.
5. Press **Activation Prompts**.

### SWITCHING BLUECRUISE ON AND OFF

#### Switching BlueCruise On

The controls are on the steering wheel.

#### Using Activation Prompts



When the prompt appears, press the button to switch BlueCruise on.

The indicator appears in the instrument cluster. When the system is on, the color of the indicator changes to indicate the system status.

**Note:** *You must enable activation prompts in the touchscreen.*

# BlueCruise (If Equipped)

## Using Steering Wheel Controls



Using the adaptive cruise control and lateral support buttons, make sure both systems are active. BlueCruise activates.



## Switching BlueCruise Off



Press either the lateral support or adaptive cruise control button when system is active or in standby mode.



BlueCruise turns off through each ignition cycle.

## BLUECRUISE ALERTS

When BlueCruise is providing hands-on driving or transitioning to hands-on driving from hands-free driving and detects no steering activity for a certain period of time, the system alerts you with a message in the instrument cluster to put your hands on the steering wheel. After the first alert, the system alerts you with a message in the instrument cluster and an audible warning.

When BlueCruise is providing hands-on or hands-free driving and detects you are not looking at the road for a certain period of time, the system alerts you to return your eyes to the road. Depending on where you are looking, the alert can be a message in the instrument cluster and an audible warning.

If you do not react to the warnings, BlueCruise cancels, quickly activates and releases the brakes, and slows your vehicle down to low speeds while maintaining steering control.

If your vehicle slows down and you resume control, a message appears to prompt you to press the accelerator pedal to allow the system to resume.

**Note:** *If the system detects repeated inactivity, it disables until the next key cycle.*

## BLUECRUISE AUTOMATIC CANCELLATION

When an external condition cancels BlueCruise, for example, no lane markings available, a tone sounds and a message appears in the instrument cluster.



If your vehicle starts to slow down, you must take control of steering and press and release the button to reactivate BlueCruise.

System cancellation can also occur if:

- The lane becomes too narrow.
- The system cannot detect valid lane markings.
- Lane markings cross.
- Your eyes are not on the road or your hands are not on the steering wheel.

If you have your hands on the steering wheel and your eyes are on the road when the feature is active and a cancellation occurs, the system sounds a tone and displays a cancelled graphic in the instrument cluster.

If you are not paying attention to the road or your hands are not on the steering wheel and a cancellation occurs, the system displays a message and a tone sounds until you resume control. If you do not resume control in time, BlueCruise quickly activates and releases the brakes, and slows your

## BlueCruise (If Equipped)

vehicle to low speeds while maintaining steering control. If your vehicle slows down and you resume control, a message appears to prompt you to press the accelerator pedal to allow the system to resume.

**Note:** *The system disables until the vehicle is turned off and back on if it detects repeated inactivity.*

### BLUECRUISE INDICATORS



When on, the color of the indicator changes to indicate the status.

Gray indicates BlueCruise is on but inactive.

Green indicates BlueCruise is active and applying continuous steering support.

Blue indicates BlueCruise is active and hands-free driving mode is available.

### Hands-On Driving Support Available



The graphic in the cluster changes to a wheel with hands on it indicating hands-on driving mode is active.

When this indicator is present, you must keep your hands on the steering wheel.

### Hands-Free Driving Support Available



The graphic in the cluster changes to a wheel without hands on it indicating hands-free driving mode is available.

When this indicator is present, you can remove your hands from the steering wheel.

### BLUECRUISE – TROUBLESHOOTING

### BLUECRUISE – INFORMATION MESSAGES

Depending on your vehicle options and instrument cluster type, not all messages display or are available.



## BlueCruise (If Equipped)

Message	Details
Keep Hands on Steering Wheel	Make sure you return your hands to the steering wheel and provide steering input.
Resume Control	The system is going to cancel and you must take control.
Watch the Road	Return your attention to the road.
BlueCruise not available	Conditions exist preventing the system from being available. If the message continues to display, have the system checked as soon as possible.
Press Accelerator Pedal to Resume	Press the accelerator pedal and follow the prompts.
Driver monitor camera cannot detect face See manual	Make sure your facial features are visible and in the field of view of the driver facing camera.
Driver monitor camera is blocked See manual	Make sure your hands, arms or other objects are not obscuring the camera.
Driver monitor camera fault See manual	Conditions exist preventing the system from being available. If the message continues to display, have the system checked as soon as possible.
BlueCruise On Watch the road Be prepared to resume control	BlueCruise is active, keep your attention on the road.
BlueCruise available Press {ICON} to activate	The system is in standby mode, press the button on the steering wheel to activate.

**Note:** *The instrument cluster display may abbreviate or shorten certain messages.*

# Drive Mode Control

## WHAT IS DRIVE MODE CONTROL

Your vehicle has various drive modes that you can select for different driving conditions. Depending on the drive mode that you select, the system adjusts various vehicle settings.

## HOW DOES DRIVE MODE CONTROL WORK

Selectable drive modes change various electronic settings within your vehicle to tailor its performance and driving characteristics to on-road or off-road conditions. The following controls are automatically altered to a predetermined setting depending on the drive mode that is selected.

- Steering feel and effort.
- Traction control.
- Chassis controls.
- Powertrain response.
- Propulsion sound.
- E-locker engagement.
- Cluster graphics.
- One pedal drive.

**Note:** *Your vehicle reverts to normal mode each time it is started. If you shut your vehicle off in a drive mode other than normal mode, at startup the instrument cluster screen displays a pop-up asking if you would like to return to your last used drive mode. If you select yes to the pop-up, your vehicle returns to the last selected drive mode. If you select no, your vehicle remains in normal mode. If you do not select yes or no, the pop up message times out and your vehicle remains in normal mode.*

## SELECTING A DRIVE MODE

If your vehicle is equipped with a 15 inch touchscreen.

1. Access the vehicle drawer on the touchscreen.
2. Press **CONTROLS**.
3. Press **DRIVE MODES**.
4. Press Normal, Sport, Tow/Haul, or Off-Road to select the desired drive mode.

If your vehicle is equipped with a 12 inch touchscreen.

1. Access Features on the touchscreen.
2. Press **CONTROLS**.
3. Press **DRIVE MODES**.
4. Press Normal, Sport, Tow/Haul, or Off-Road to select the desired drive mode.

**Note:** *Drive mode changes may not be available when your vehicle is off.*

## DRIVE MODES

### NORMAL



For everyday driving. This mode is a perfect balance of excitement, comfort and convenience. All systems that are altered by drive mode control are set to their default settings.

**Note:** *One pedal drive is available in this mode.*

# Drive Mode Control

## OFF-ROAD



For driving on rough uneven terrain. This mode optimizes accelerator pedal response to give you more control over your vehicle when traversing off-road obstacles. Traction control and stability control settings are optimized, and the rear electronic differential is automatically engaged to enhance vehicle performance in off-road environments. Use this mode when driving through sand, loose gravel, mud, or mixed off-road terrain.

**Note:** *One Pedal Drive is not available in this mode.*

## SPORT



For sporty driving with improved performance handling and response. This mode increases accelerator pedal responsiveness and provides a stronger deceleration rate when you lift your foot off the accelerator pedal for a spirited driving experience. Powertrain tuning is altered to maximize performance traction and steering feel is altered to have more torque buildup enhancing driver connectivity and feedback. Additionally, propulsion sound is set to its most aggressive setting.

**Note:** *One pedal drive is available and is set to its Sport setting.*

**Note:** *Propulsion sound may not be available for all trim levels.*

## TOW/HAUL



For improved vehicle operation when towing a trailer or hauling a heavy load. This mode adjusts powertrain tuning and enhances steering response to assist in controlling your vehicle when towing a trailer or hauling large loads in the bed. Additionally, grade braking assist is activated to maintain vehicle speed when descending grades.

**Note:** *One Pedal Drive is not available in this mode.*

**Note:** *In certain situations, grade braking assist may not be available. The driver should always be prepared to control vehicle speed with the brake pedal.*

## DRIVE MODE CONTROL – TROUBLESHOOTING

### DRIVE MODE CONTROL – WARNING LAMPS



Some drive modes reduce traction and stability control performance and the indicator illuminates in the instrument cluster.

### DRIVE MODE CONTROL – FREQUENTLY ASKED QUESTIONS

#### Why did the system default to normal mode?

If a mode is unavailable due to a system fault, it defaults to normal mode.

# One Pedal Drive

## WHAT IS ONE PEDAL DRIVE

One pedal drive allows you to accelerate and brake using only the accelerator pedal. Pressing the accelerator down accelerates your vehicle, releasing pressure on the accelerator with your foot still on the pedal slows down your vehicle and releasing the pedal completely allows your vehicle to come to a complete stop.

## ONE PEDAL DRIVE PRECAUTIONS



**WARNING:** This system is an extra driving aid. It does not replace your attention and judgment, or the need to apply the brakes. This system does NOT automatically brake your vehicle. If you fail to press the brake pedal when necessary, you may collide with another vehicle.

Shifting into neutral (N) does not hold your vehicle at a standstill.

Shifting into drive (D) or reverse (R) does not cause the vehicle to move if the accelerator pedal is not pressed.

**Note:** Always check the transmission selection before accelerating.

## ONE PEDAL DRIVE LIMITATIONS

One pedal drive is unavailable when any of the following occur:

- A drive mode other than normal or sport is selected.
- Cruise control is active.
- Stability control is turned off.
- Trailer hitch assist is active.
- Active park assist is active.

- Remote park assist is active.
- Gear lever is in an incorrect transmission position, such as park (P) while driving.

Releasing the accelerator pedal may not bring your vehicle to a complete stop on steep grades.

Increased vehicle load or towing a trailer may reduce accelerator pedal ability to slow the vehicle.

## SWITCHING ONE PEDAL DRIVE ON AND OFF - VEHICLES WITH: 12.3 INCH SCREEN

1. Press Features on the touchscreen
2. Press **DRIVE MODES**.
3. Switch **1-Pedal Drive** on or off.

## SWITCHING ONE PEDAL DRIVE ON AND OFF - VEHICLES WITH: 15 INCH SCREEN

1. Access the vehicle drawer on the touchscreen.
2. Press **CONTROLS**.
3. Press **Drive Modes**.
4. Switch **1-Pedal Drive** on or off.

## ONE PEDAL DRIVE INDICATORS



When one pedal drive is active, the indicator displays in the instrument cluster.

# Lane Keeping System

## WHAT IS THE LANE KEEPING SYSTEM

The lane keeping system alerts you by providing temporary steering assistance or steering wheel vibration when it detects an unintended lane departure.

## HOW DOES THE LANE KEEPING SYSTEM WORK

The lane keeping system uses a forward looking camera mounted on the windshield to monitor vehicle movement within the travel lane.

When the camera detects a drift out of the travel lane, the lane keeping system alerts the driver by vibrating the steering wheel, or aids the driver by providing a small steering input to move the vehicle back into the travel lane.

The driver can select one of three modes:

- Alert (If Equipped)
- Aid
- Alert + Aid

## LANE KEEPING SYSTEM PRECAUTIONS

 **WARNING:** You are responsible for controlling your vehicle at all times. The system is designed to be an aid and does not relieve you of your responsibility to drive with due care and attention. Failure to follow this instruction could result in the loss of control of your vehicle, personal injury or death.

 **WARNING:** The system will not operate if the sensor cannot track the road lane markings.

 **WARNING:** The sensor may incorrectly track lane markings as other structures or objects. This can result in a false or missed warning.

 **WARNING:** In cold and severe weather conditions the system may not function. Rain, snow and spray can all limit sensor performance.

 **WARNING:** The system may not operate properly if the sensor is blocked. Keep the windshield free from obstruction.

 **WARNING:** If damage occurs in the immediate area surrounding the sensor, have your vehicle checked as soon as possible.

 **WARNING:** The system may not correctly operate if your vehicle is fitted with a suspension kit not approved by us.

 **WARNING:** Large contrasts in outside lighting can limit sensor performance.

## LANE KEEPING SYSTEM LIMITATIONS

The lane keeping system only operates when the vehicle speed is greater than 40 mph (64 km/h).

The system works when the camera can detect at least one lane marking.

**Note:** When you select Aid or Alert and Aid mode and the system detects no steering activity for a short period of time, the system alerts you to put your hands on the steering wheel. The system may detect a light grip or touch on the steering wheel as hands-off driving.

# Lane Keeping System

The lane keeping system may not correctly operate in any of the following conditions:

- The lane keeping system does not detect at least one lane marking.
- You switch the turn signal on.
- You apply direct steering, accelerate fast or brake hard.
- The vehicle speed is less than 40 mph (64 km/h).
- The anti-lock brake, stability control or traction control system activates.
- The lane is too narrow.
- Something is obscuring the camera or it is unable to detect the lane markings due to environment, traffic or vehicle conditions.
- Entering or exiting a tight curve when driving at high speeds.

The lane keeping system may not correct lane positioning in any of the following conditions:

- High winds.
- Uneven road surfaces.
- Heavy or uneven loads.
- Incorrect tire pressure.

## SWITCHING THE LANE KEEPING SYSTEM ON AND OFF



To activate the lane keeping system, press the button on the steering wheel.

To deactivate the lane keeping system, press the button again.

**Note:** When switching the system on or off a message appears in the information and entertainment display to show the status.

**Note:** The system stores the on or off setting until manually changed, unless it detects a MyKey™. If the system detects a MyKey™, it defaults to the last setting for that MyKey™.

**Note:** If the system detects a MyKey™, pressing the button does not affect the on or off status of the system. You can only change the mode and intensity settings.

## SWITCHING THE LANE KEEPING SYSTEM MODE - VEHICLES WITH: 12.3 INCH SCREEN

The lane keeping system has different settings that you can view or adjust using the information display.

The system stores the last known selection for each of these settings. You do not need to readjust your settings each time you switch on the system.

To change the lane keeping system mode, use the touchscreen:

1. Press **Features** on the touchscreen.
2. Press **Driver Assistance**.
3. Press **Lane-Keeping System**.
4. Press **Lane-Keeping Mode**.
5. Select a mode.

**Note:** The system remembers the last setting when you start your vehicle. If the system detects a MyKey™, it defaults to the last setting for that MyKey™.

# Lane Keeping System

## SWITCHING THE LANE KEEPING SYSTEM MODE - VEHICLES WITH: 15 INCH SCREEN

The lane keeping system has different settings that you can view or adjust using the information display.

- Alert (If Equipped)
- Aid
- Alert and Aid

The system permanently stores the last known selection for each setting.

To change the lane keeping system mode, access the vehicle drawer on the touchscreen:

1. Press **SETTINGS**.
2. Press **Driver Assistance**.
3. Press **Lane-Keeping System**.
4. Press **Lane-Keeping Mode**.
5. Select a setting.

**Note:** *The system remembers the last setting when you start your vehicle.*

## ALERT MODE

### WHAT IS ALERT MODE

Alert mode vibrates the steering wheel when it detects an unintended lane departure.

## HOW DOES ALERT MODE WORK

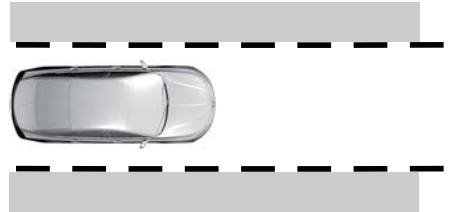

When in alert mode, the lane keeping system alerts you by vibrating the steering wheel. The intensity of the vibration is set through the lane keeping system menu.

## ADJUSTING THE STEERING WHEEL VIBRATION INTENSITY

To change the steering wheel vibration intensity, use the touchscreen:

1. Press **Features** on the touchscreen.
2. Press **Driver Assistance**.
3. Press **Lane-Keeping System**.
4. Press **Lane-Keeping Intensity**.
5. Select an intensity setting.

## AID MODE

### WHAT IS AID MODE

Aid mode provides temporary steering assistance toward the center of the lane.

# Lane Keeping System

## HOW DOES AID MODE WORK

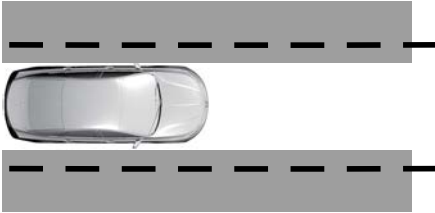

The lane keeping system aids you when an unintentional lane departure occurs. The system provides a small steering input to move the vehicle towards the center of the lane.

## ALERT AND AID MODE

### WHAT IS ALERT AND AID MODE

Alert and aid mode uses multiple features to keep you in your lane. The system first provides a small steering input to bring your vehicle back towards the center of the lane. If your vehicle moves too far out of the center of the lane the system alerts you with vibration in the steering wheel.

## HOW DOES ALERT AND AID MODE WORK

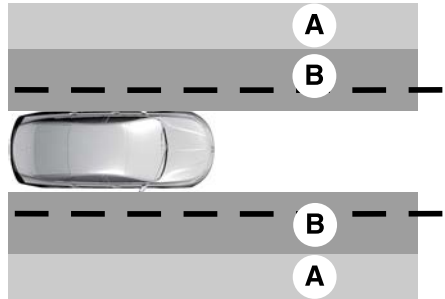

- A Alert.
- B Aid.

The lane keeping system detects a lane departure and provides aid when the vehicles enters **B** and applies the additional alert warning if **A** is entered.

## LANE KEEPING SYSTEM INDICATORS

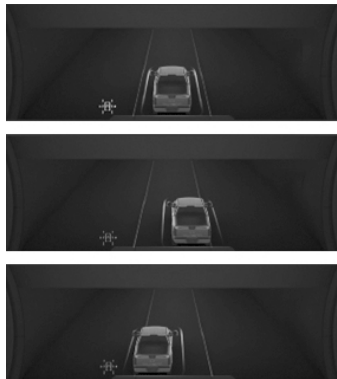



# Lane Keeping System

If you switch the lane keeping system on, a graphic with lane markings appears in the information display.

When you switch the system off, the lane marking graphics do not display.

**Note:** *The overhead vehicle graphic may still display if adaptive cruise control is enabled.*

While the lane keeping system is on, the color of the lane markings change to indicate the system status.

Gray	Green	Yellow	Red
Indicates that the system is temporarily unavailable to provide a warning or intervention on the indicated side.	Indicates that the system is available or ready to provide a warning or intervention on the indicated side.	Indicates that the system is providing or has just provided a lane keeping aid intervention.	Indicates that the system is providing or has just provided a lane keeping alert warning.

## LANE KEEPING SYSTEM – TROUBLESHOOTING

### LANE KEEPING SYSTEM – INFORMATION MESSAGES

Message	Action
Lane Keeping Sys. Malfunction Service Required	The system has malfunctioned. Have your vehicle checked as soon as possible.
Front Camera Temporarily Not Available	The system has detected a condition that has caused the system to be temporarily unavailable.
Front Camera Low Visibility Clean Screen	The system has detected a condition that requires you to clean the windshield in order for it to operate properly.
Front Camera Malfunction Service Required	The system has malfunctioned. Have your vehicle checked as soon as possible.
Keep Hands on Steering Wheel	The system requests that you keep your hands on the steering wheel.

# Lane Keeping System

## LANE KEEPING SYSTEM – FREQUENTLY ASKED QUESTIONS

<b>Why is the feature not available (lane markings are gray) when I can see the lane markings on the road?</b>
Your vehicle speed is less than 40 mph (65 km/h).
The sun is shining directly into the camera lens.
A quick intentional lane change has occurred.
Your vehicle stays too close to the lane markings for an extended interval of time.
Driving at high speeds in curves.
The last alert warning or aid intervention occurred a short time ago.
Ambiguous lane markings, for example, in construction zones.
Rapid transition from light to dark, or from dark to light.
Sudden offset in lane markings.
ABS or AdvanceTrac™ is active.
There is a camera blockage due to dirt, grime, fog, frost or water on the windshield.
You are driving too close to the vehicle in front of you.
Transitioning between no lane markings to lane markings, or vice versa.
There is standing water on the road.
Faint lane markings, for example, partial yellow lane markings on concrete roads.
Lane width is too narrow or too wide.
You have not calibrated the camera after a windshield replacement.
Driving on tight or on uneven roads.

# Lane Keeping System

---

**Why does the vehicle not come back toward the middle of the lane, as expected, in the Aid, or Aid + Alert mode?**

High cross winds are present.

There is a large road crown.

Rough roads, grooves or shoulder drop-offs.

Heavy, uneven loading of the vehicle or improper tire inflation pressure.

You changed the tires or modified the suspension.

# Blind Spot Information System

## WHAT IS BLIND SPOT INFORMATION SYSTEM

Blind spot information system detects vehicles that may have entered the blind spot zone.

## HOW DOES BLIND SPOT INFORMATION SYSTEM WORK

Blind spot information system uses sensors on both sides of your vehicle, detecting rearward from the exterior mirrors to approximately 13 ft (4 m) beyond the rear bumper. The detection area extends to approximately 59 ft (18 m) beyond the rear bumper when the vehicle speed is greater than 30 mph (48 km/h) to alert you of faster approaching vehicles.

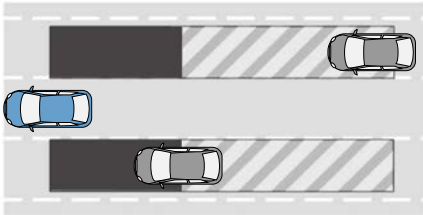

## BLIND SPOT INFORMATION SYSTEM PRECAUTIONS



**WARNING:** Do not use the blind spot information system as a replacement for using the interior and exterior mirrors or looking over your shoulder before changing lanes. The blind spot information system is not a replacement for careful driving.



**WARNING:** The system may not operate properly during severe weather conditions, for example snow, ice, heavy rain and spray. Always drive with due care and attention. Failure to take care may result in a crash.

**Note:** *Blind spot information system does not prevent contact with other vehicles. It does not detect parked vehicles, pedestrians, animals or other infrastructure.*

## BLIND SPOT INFORMATION SYSTEM LIMITATIONS

Blind spot information system does not operate in park (P) or reverse (R).

The system may not alert you if a vehicle quickly passes through the detection zone.

## BLIND SPOT INFORMATION SYSTEM REQUIREMENTS

Blind spot information system turns on when all the following occur:

- You start your vehicle.
- You shift into drive (D).
- The vehicle speed is greater than 6 mph (10 km/h).

## SWITCHING BLIND SPOT INFORMATION SYSTEM ON AND OFF - VEHICLES WITH: 12.3 INCH SCREEN

To switch blind spot information system on or off, use the touchscreen:

1. Press **Features** on the touchscreen.
2. Press **Driver Assistance**.
3. Press **Blind Spot Information System**.

# Blind Spot Information System

## 4. Switch the feature on or off.

When you switch blind spot information system off, a warning lamp illuminates and a message displays. When you switch the system on or off, the alert indicators flash twice.

**Note:** *The system remembers the last setting when you start your vehicle.*

To permanently switch the system off, contact an authorized dealer.

## SWITCHING BLIND SPOT INFORMATION SYSTEM ON AND OFF - VEHICLES WITH: 15 INCH SCREEN

To switch blind spot information system on or off, use the touchscreen:

1. Access the vehicle drawer.
2. Press **SETTINGS**.
3. Press **Driver Assistance**.
4. Switch **Blind Spot Information System** on or off.

**Note:** *Some vehicles may not have the ability to switch the feature on or off.*

When you switch blind spot information system off, a warning lamp illuminates and a message displays. When you switch the system on or off, the alert indicators flash twice.

**Note:** *The system remembers the last setting when you start your vehicle.*

To permanently switch the system off, contact an authorized dealer.

## LOCATING THE BLIND SPOT INFORMATION SYSTEM SENSORS

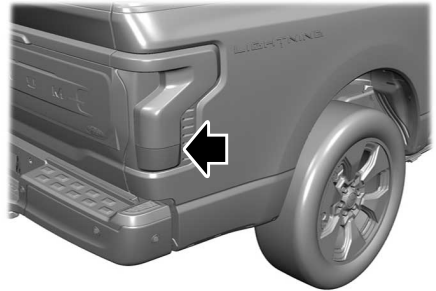

The sensors are inside the brake lamp on both sides of your vehicle.

**Note:** *Keep the sensors free from snow, ice and large accumulations of dirt.*

**Note:** *Do not cover the sensors with bumper stickers, repair compound or other objects.*

**Note:** *Bike and cargo racks could cause false alerts due to obstruction of the sensor. We recommend switching the feature off when using a bike or cargo rack.*

**Note:** *Blocked sensors may affect system accuracy.*

If the sensors become blocked, a message appears in the instrument cluster display. See **Blind Spot Information System – Information Messages** (page 308). The alert indicators illuminate but the system does not alert you.

# Blind Spot Information System

## BLIND SPOT INFORMATION SYSTEM WITH TRAILER COVERAGE (IF EQUIPPED)

### WHAT IS BLIND SPOT INFORMATION SYSTEM WITH TRAILER COVERAGE

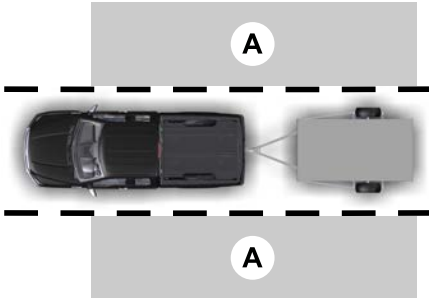

Blind spot information system detects vehicles that may have entered the blind spot zone. The detection area is on both sides your vehicle and trailer, extending rearward from the exterior mirrors to the end of your trailer.

### BLIND SPOT INFORMATION SYSTEM WITH TRAILER COVERAGE LIMITATIONS

Trailer coverage only supports conventional trailers. The system turns off if you select a fifth wheel trailer type.

Make sure the trailer width is less than or equal to 8.5 ft (2.6 m) and the length is less than 33 ft (10.1 m). If you input values higher, the system turns off.

Some trailers could cause a slight change in system performance:

- Large box trailers could cause false alerts to occur when driving next to infrastructures or near parked cars. A false alert could also occur while making a 90-degree turn.
- Trailers that have a width greater than 8.5 ft (2.6 m) at the front and have a total length greater than 20 ft (6 m) could cause delayed alerts when a vehicle is passing at high speeds.
- Box trailers that have a width greater than 8.5 ft (2.6 m) at the front could cause early alerts when you pass a vehicle.
- Clam shell or v-nose box trailers with a width greater than 8.5 ft (2.6 m) at the front could cause delayed alerts when a vehicle traveling the same speed as your vehicle merges lanes.

### SETTING A TRAILER LENGTH

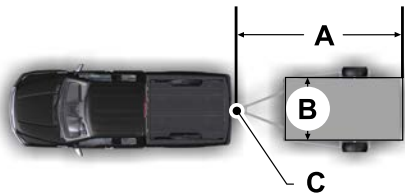

- A Trailer length.
- B Trailer width.
- C Trailer hitch ball.

You can set-up a trailer to work with the blind spot information system through the touchscreen. When setting up a trailer, a sequence of screens appear asking for trailer information.

1. Select type of trailer screen - conventional, fifth wheel or gooseneck.

# Blind Spot Information System

**Note:** The system only supports conventional trailers.

2. Do you want to set up blind spot with trailer screen? If no, the system turns off. If yes, the menu goes to the next screen.
3. Is the width less than 9 ft (2.7 m) and length less than 33 ft (10.1 m)? If no, the system turns off. If yes, the menu goes to the next screen.
4. Trailer width measurement. Measure the width at the front of the trailer. It is not measured at the widest point of the trailer. The maximum width at the front of the trailer the system can support is 8.5 ft (2.6 m).

**Note:** You do not need to enter an exact trailer width measurement. You only need to confirm that the width of the trailer is less than 9 ft (2.7 m).

5. Trailer length measurement. The trailer length is the distance between the trailer hitch ball and the rear of the trailer. The maximum length that the system can support is 33 ft (10.1 m).
6. Enter the length of trailer. The default setting is 18 ft (5.5 m). Toggling up or down using the menu buttons increases or decreases the measurement by 1 ft (0.3 m). Select a length that is equal to or within 1 ft (0.3 m) of the actual measured length. For example, if the actual measure length is 23 ft (7 m), toggle the length in the menu to 24 ft (7.2 m). The system setup saves when you enter the length of the trailer.

**Note:** If the trailer is a bike rack or cargo rack with electrical lighting, enter a length of around 3 ft (1 m). Cross traffic alert remains on for trailers with a length of 3 ft (1 m) or less.

**Note:** The system requires proper measurement and measure entry to function properly.

## SELECTING A TRAILER

When you connect a trailer to your vehicle, the trailer set up menu appears in the touchscreen. This menu allows you to set up a new trailer or choose from a previously set up trailer. A warning message appears and the system turns off if you do not choose or add a new trailer.

**Note:** The warning message may not appear until your vehicle reaches 22 mph (35 km/h).

## BLIND SPOT INFORMATION SYSTEM INDICATORS



When blind spot information system detects a vehicle, an alert indicator illuminates in the exterior mirror on the side the approaching vehicle is coming from. If you turn the turn signal on for that side of your vehicle, the alert indicator flashes.

# Blind Spot Information System

---

## BLIND SPOT INFORMATION SYSTEM – TROUBLESHOOTING

### BLIND SPOT INFORMATION SYSTEM – INFORMATION MESSAGES

<b>Message</b>	<b>Action</b>
Blind Spot System Fault	A fault with the system has occurred. Have your vehicle checked as soon as possible.
Blind Spot Not Available Sensor Blocked See Manual	Something is blocking the sensors. Clean the sensors.
Blind Spot Alert Deactivated Trailer Attached	The system automatically turns off and displays this message when you connect a trailer to the vehicle that does not have a trailer blind spot system or when you switch the trailer blind spot system off through the touchscreen.



# Cross Traffic Alert (If Equipped)

## WHAT IS CROSS TRAFFIC ALERT

The system alerts you of vehicles approaching from the sides behind your vehicle when you shift into reverse (R).

## HOW DOES CROSS TRAFFIC ALERT WORK

Cross traffic alert detects vehicles that approach at a speed between 4–37 mph (6–60 km/h). Coverage decreases when the sensors are partially, mostly or fully obstructed.

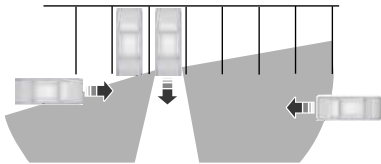

The sensor on the left-hand side is only partially obstructed and zone coverage on the right-hand side is maximized.

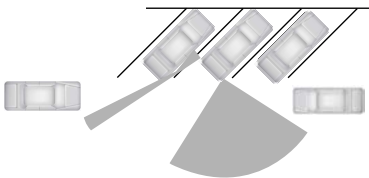

Zone coverage also decreases when parking at narrow angles. The sensor on the left-hand side is mostly obstructed and zone coverage on that side is severely reduced.

**Note:** *Slowly reversing helps increase the coverage area and effectiveness.*

## CROSS TRAFFIC ALERT PRECAUTIONS

**WARNING:** Do not use the cross traffic alert system as a replacement for using the interior and exterior mirrors or looking over your shoulder before reversing out of a parking space. The cross traffic alert system is not a replacement for careful driving.

**WARNING:** The system may not operate properly during severe weather conditions, for example snow, ice, heavy rain and spray. Always drive with due care and attention. Failure to take care may result in a crash.

## CROSS TRAFFIC ALERT LIMITATIONS

The system may not correctly operate when any of the following occur:

- Something is blocking the sensors.
- Adjacently parked vehicles or objects are obstructing the sensors.
- Vehicles approach at speeds less than 4 mph (6 km/h) or greater than 37 mph (60 km/h).
- Your vehicle speed is greater than 7 mph (12 km/h).
- You reverse out of an angled parking space.

## Cross Traffic Alert (If Equipped)

### Cross Traffic Alert Limitations with a Trailer Attached

The system remains on when you attach a trailer in vehicles with blind spot information system with trailer tow under the following conditions:

- You connect a trailer.
- The trailer is a bike rack or cargo rack with a maximum length of 3 ft (1 m).
- You set the trailer length to 3 ft (1 m) in the instrument cluster display.

**Note:** *The system may not correctly operate when towing a trailer. For vehicles with an approved trailer tow module and tow bar, the system turns off when you attach a trailer. For vehicles with an aftermarket trailer tow module or tow bar, we recommend that you switch the system off when you attach a trailer.*

### SWITCHING CROSS TRAFFIC ALERT ON AND OFF - VEHICLES WITH: 12.3 INCH SCREEN

To switch cross traffic alert on or off use the touchscreen.

1. Press **Features** on the touchscreen.
2. Press **Driver Assistance**.
3. Switch **Cross Traffic Alert** on or off.

**Note:** *Some vehicles may not have the ability to switch the feature on or off.*

**Note:** *The system switches on every time you switch the ignition on. To permanently switch the system off, contact an authorized dealer.*

### SWITCHING CROSS TRAFFIC ALERT ON AND OFF - VEHICLES WITH: 15 INCH SCREEN

To switch cross traffic alert on or off use the touchscreen:

1. Access the vehicle drawer.
2. Press **SETTINGS**.
3. Press **Driver Assistance**.
4. Switch **Cross Traffic Alert** on or off.

When you switch the system on or off, the alert indicators flash twice.

**Note:** *The system turns on every time you start your vehicle. To permanently switch the system off, contact an authorized dealer.*

### LOCATING THE CROSS TRAFFIC ALERT SENSORS

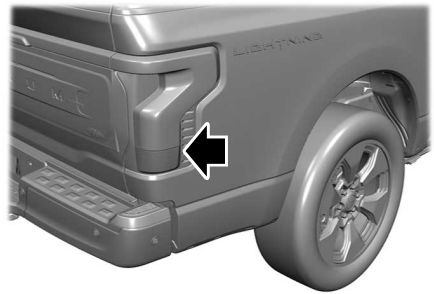

The sensors are inside the brake lamp on both sides of your vehicle.

**Note:** *Keep the sensors free from snow, ice and large accumulations of dirt.*

**Note:** *Do not cover the sensors with bumper stickers, repair compound or other objects.*

## Cross Traffic Alert (If Equipped)

**Note:** Blocked sensors may affect system accuracy.

If something is blocking the sensors, a message may appear in the information display when you shift into reverse (R).

**Note:** Bike and cargo racks could cause false alerts due to obstruction of the sensor. We recommend switching the feature off when using a bike or cargo rack.

### CROSS TRAFFIC ALERT INDICATORS



When the cross traffic alert detects an approaching vehicle, a tone sounds, a warning lamp illuminates in the relevant exterior mirror and arrows appear in the information display to show which side the vehicle is approaching from.

If the system malfunctions, a warning lamp illuminates in the instrument cluster and a message appears in the information display. Have your vehicle checked as soon as possible.

**Note:** If arrows do not display, a message appears in the information display.

**Note:** In some conditions, the system could alert you, even when there is nothing in the detection zone, for example a vehicle passing further away from your vehicle.

### CROSS TRAFFIC ALERT – TROUBLESHOOTING

#### CROSS TRAFFIC ALERT – INFORMATION MESSAGES

Message	Action
Cross Traffic Alert	Displays instead of indication arrows when the system detects a vehicle. Check for approaching traffic.
Cross Traffic Not Available Sensor Blocked See Manual	Indicates blocked cross traffic alert system sensors. Clean the sensors. If the message continues to appear, have your vehicle checked as soon as possible.
Cross Traffic System Fault	The system has malfunctioned. Have your vehicle checked as soon as possible.
Cross Traffic Alert Deactivated Trailer Attached	Displays if you attach a trailer to your vehicle.

# Pre-Collision Assist

## WHAT IS PRE-COLLISION ASSIST

Pre-collision assist detects and warns of approaching hazards in the roadway. The system provides multiple levels of assistance to help avoid a collision if your vehicle is rapidly approaching another stationary vehicle, a vehicle traveling in the same direction as yours, or a pedestrian or cyclist within your driving path.

## HOW DOES PRE-COLLISION ASSIST WORK

The system warns the driver of potential hazards by providing three levels of assistance.



If your vehicle is rapidly approaching potential hazards the system provides the following levels of functionality:

1. Alert.
2. Brake Support.
3. Automatic Emergency Braking.



**Alert:** When active, a flashing visual warning appears and an audible warning tone sounds.

**Brake Support:** The system is designed to help reduce the impact speed by preparing the brakes for rapid braking. The system does not automatically apply the brakes. If you press the brake pedal, the system could apply additional braking up to maximum braking force, even if you lightly press the brake pedal.

**Automatic Emergency Braking:** Automatic emergency braking may activate if the system determines that a collision is imminent.

**Note:** If you perceive the pre-collision assist alerts as being too frequent or disturbing, then you can reduce the alert sensitivity. Setting the low sensitivity would result in fewer and later warnings of a potential forward collision. The manufacturer recommends using the high sensitivity setting where possible. The sensitivity setting does not affect the performance of the automatic emergency braking.

**Note:** Automatic emergency braking performance is not affected by the sensitivity setting.

Each system has various levels of detection capabilities. See **Pre-Collision Assist Limitations** (page 313).

## PRE-COLLISION ASSIST PRECAUTIONS



**WARNING:** You are responsible for controlling your vehicle at all times. The system is designed to be an aid and does not relieve you of your responsibility to drive with due care and attention. Failure to follow this instruction could result in the loss of control of your vehicle, personal injury or death.



**WARNING:** The system does not detect vehicles moving in a different direction or animals. Apply the brakes when necessary. Failure to follow this instruction could result in the loss of control of your vehicle, personal injury or death.



**WARNING:** The system does not operate during hard acceleration or steering. Failure to take care may lead to a crash or personal injury.

# Pre-Collision Assist



**WARNING:** The system may fail or operate with reduced function during cold and severe weather conditions. Snow, ice, rain, spray and fog can adversely affect the system. Keep the front camera and radar free of snow and ice. Failure to take care may result in the loss of control of your vehicle, serious personal injury or death.



**WARNING:** Take additional care if your vehicle is heavily loaded or you are towing a trailer. These conditions could result in reduced performance of this system. Failure to follow this instruction could result in the loss of control of your vehicle, personal injury or death.



**WARNING:** The system cannot help prevent all crashes. Do not rely on this system to replace driver judgment and the need to maintain a safe distance and speed.



**WARNING:** In situations where the vehicle camera has limited detection capability, this may reduce system performance. These situations include but are not limited to direct or low sunlight, vehicles at night without tail lights, unconventional vehicle types, pedestrians with complex backgrounds, running pedestrians, partly obscured pedestrians, or pedestrians that the system cannot distinguish from a group. Failure to take care may result in the loss of control of your vehicle, serious personal injury or death.

## PRE-COLLISION ASSIST LIMITATIONS

Pre-collision assist depends on the detection ability of its camera and sensors. Any obstructions or damage to these areas can limit detection or prevent the system from functioning. See **Locating the Pre-Collision Assist Sensors** (page 315).

The system is active at speeds above 3 mph (5 km/h).

**Note:** *The pre-collision assist system automatically disables when you manually disable AdvanceTrac™.*

**Note:** *Brake support and automatic emergency braking are active up to the maximum speed of the vehicle.*

### Pedestrian Detection Limitations

Pedestrian detection is active at speeds up to 50 mph (80 km/h).

Pedestrian detection operates optimally when detected hazards are clearly identifiable. System performance may reduce in situations where pedestrians are running, partly obscured, have a complex background, or cannot be distinguished from a group.

### Cyclist Detection Limitations

Cyclist detection is active at speeds up to 50 mph (80 km/h).

Cyclist detection functions optimally when detected hazards are clearly identifiable. System performance may reduce in situations where cyclists are fast-moving, partly obscured, have a complex background, or cannot be distinguished from a group.

# Pre-Collision Assist

## Intersection Assist (If Equipped)

If your vehicle comes with a radar sensor included in adaptive cruise control, the pre-collision assist system may operate in a scenario where you are turning across an oncoming vehicle's path. Detection of vehicles driving in an oncoming direction is active if your vehicle is driving at speeds up to 50 mph (80 km/h).

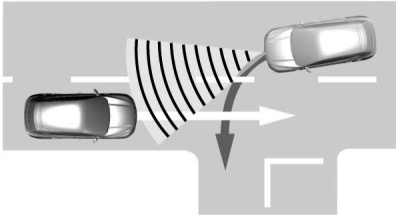

## SWITCHING PRE-COLLISION ASSIST ON AND OFF - VEHICLES WITH: 12.3 INCH SCREEN

To switch the system on or off, use the touchscreen:

1. Press **Features** on the touchscreen.
2. Press **Driver Assistance**.
3. Press **Pre-Collision Assist**.
4. Switch the feature on or off.

## Adjusting the Pre-Collision Assist Settings

You can adjust the following settings by using the touchscreen controls in the pre-collision assist menu:

- Change alert and distance alert sensitivity to one of three possible settings.
- Switch distance indication and alert on or off.
- If required, switch automatic emergency braking on or off.
- If required, switch the entire pre-collision assist feature on or off.
- If required, switch evasive steering assist on or off.

**Note:** *Automatic emergency braking and evasive steering turn on every time you switch the ignition on.*

**Note:** *If your vehicle has a radar sensor, we recommend that you switch the system off if you install a snow plow or similar object in such a way that it may block the radar sensor. Your vehicle remembers the selected setting across key cycles.*

**Note:** *If you switch automatic emergency braking off, evasive steering assist switches off.*

## SWITCHING PRE-COLLISION ASSIST ON AND OFF - VEHICLES WITH: 15 INCH SCREEN

To switch the system on or off:

1. Access the vehicle drawer.
2. Press **SETTINGS**.
3. Press **Driver Assistance**.
4. Press **Pre-Collision Assist**.
5. Switch the feature on or off.

# Pre-Collision Assist

## Adjusting the Pre-Collision Assist Settings

You can adjust the following settings by using the touchscreen controls in the pre-collision assist menu:

- Change alert and distance alert sensitivity to one of three possible settings.
- Switch distance indication and alert on or off.
- If required, switch automatic emergency braking on or off.
- If required, switch the entire pre-collision assist feature on or off.
- If required, switch evasive steering assist on or off.

**Note:** Automatic emergency braking and evasive steering assist automatically turn on every time you switch the ignition on.

**Note:** If your vehicle has a radar sensor, we recommend that you switch the system off if you install a snow plow or similar object in such a way that it may block the radar sensor. Your vehicle remembers the selected setting across key cycles.

**Note:** If you switch automatic emergency braking off, evasive steering assist switches off.

## LOCATING THE PRE-COLLISION ASSIST SENSORS

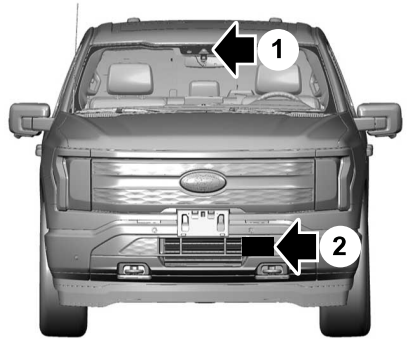

1. Camera.
2. Radar sensor (if equipped).

If a message regarding a blocked sensor or camera appears in the information display, something is obstructing the radar signals or camera images. The radar sensor is behind the fascia cover in the center of the lower grille. With a blocked sensor or camera, the system may not function, or performance may reduce. See **Pre-Collision Assist – Information Messages** (page 319).

**Note:** Proper system operation requires a clear view of the road by the camera. Have any windshield damage in the area of the camera's field of view repaired.

**Note:** If something hits the front end of your vehicle or damage occurs and your vehicle has a radar sensor, the radar sensing zone could change. This could cause missed or false vehicle detections. Have your vehicle serviced to have the radar checked for proper coverage and operation.

# Pre-Collision Assist

**Note:** *If your vehicle detects excessive heat at the camera or a potential misalignment condition, a message could display in the information display indicating temporary sensor unavailability. When operational conditions are correct, the message deactivates. For example, when the ambient temperature around the sensor decreases or the sensor recalibrates successfully.*

## DISTANCE INDICATION

### WHAT IS DISTANCE INDICATION

Distance indication displays the gap between your vehicle and the vehicle ahead of you.

**Note:** *The graphic does not display if you switch on cruise control or adaptive cruise control.*

Vehicle Speed	System Sensitivity	Distance Indicator Color	Distance Gap	Time Gap
62 mph (100 km/h).	Normal.	Gray.	Greater than 82 ft (25 m).	Greater than 0.9 seconds.
		Yellow.	56–82 ft (17–25 m).	0.6–0.9 seconds.
		Red.	Less than 56 ft (17 m).	Less than 0.6 seconds.



# Pre-Collision Assist

## SWITCHING DISTANCE INDICATION ON AND OFF

To switch the system on or off, use the touchscreen:

1. Press **Features** on the touchscreen.
2. Press **Driver Assistance**.
3. Press **Pre-Collision Assist**.
4. Switch **Distance Indication** on or off.

## DISTANCE INDICATION INDICATOR

The indicator displays the time gap between your vehicle and vehicles traveling in the same direction ahead of you.

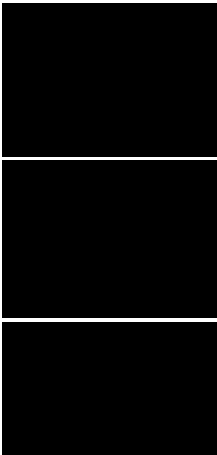

## DISTANCE ALERT

### WHAT IS DISTANCE ALERT

The system alerts you with a warning lamp if the distance to the vehicle ahead is small.

**Note:** *The warning lamp does not illuminate if cruise control or adaptive cruise control is active.*

## ADJUSTING THE SENSITIVITY OF DISTANCE ALERT

To adjust the sensitivity of the system, use the touchscreen:

1. Press **Features** on the touchscreen.
2. Press **Driver Assistance**.
3. Press **Pre-Collision Assist**.
4. Press **Alert Sensitivity**.
5. Select a setting.

## AUTOMATIC EMERGENCY BRAKING

### WHAT IS AUTOMATIC EMERGENCY BRAKING

Automatic emergency braking may activate if the system determines that a collision is imminent. The system may help reduce impact damage to avoid the crash completely.

Automatic emergency braking is only available up to certain speeds. See **Pre-Collision Assist Limitations** (page 313).

### SWITCHING AUTOMATIC EMERGENCY BRAKING ON AND OFF

To switch the system on or off, use the touchscreen:

1. Press **Features** on the touchscreen.
2. Press **Driver Assistance**.
3. Press **Pre-Collision Assist**.
4. Press **Auto Emergency Braking**.
5. Switch the feature on or off.

# Pre-Collision Assist

## EVASIVE STEERING ASSIST

### WHAT IS EVASIVE STEERING ASSIST

If your vehicle is rapidly approaching a road user, evasive steering assist helps you steer around the road user.

After you turn the steering wheel in an attempt to avoid a crash with the road user, the system applies additional steering torque to help you steer around the road user. After you pass the road user, the system applies steering torque when you turn the steering wheel to steer back into the lane. The system deactivates after you fully pass the road user.

**Note:** Road users are defined as pedestrians or bicyclists in your vehicle's path or another stationary vehicle in the same lane or a vehicle traveling in the same lane in the same direction as you. See **Pre-Collision Assist Precautions** (page 312).

### EVASIVE STEERING ASSIST LIMITATIONS

Evasive steering assist only activates when all the following occur:

- Automatic emergency braking and evasive steering assist are on.
- The system detects a road user ahead and starts to apply the brakes.
- You significantly turn the steering wheel to steer around a road user.

**Note:** Evasive steering assist does not automatically steer around a road user. If you do not turn the steering wheel, evasive steering assist does not activate.

**Note:** Evasive steering assist does not activate if the distance to the road user ahead is too small and the system cannot avoid a crash.

## SWITCHING EVASIVE STEERING ASSIST ON AND OFF - VEHICLES WITH: 12.3 INCH SCREEN

To switch the system on or off, use the touchscreen:

1. Press **Features** on the touchscreen.
2. Press **Driver Assistance**.
3. Press **Pre-Collision Assist**.
4. Switch **Evasive Steering** on or off.

**Note:** If you switch automatic emergency braking off, evasive steering assist turns off.

**Note:** Automatic emergency braking and evasive steering assist turn on every time you switch the ignition on.

## SWITCHING EVASIVE STEERING ASSIST ON AND OFF - VEHICLES WITH: 15 INCH SCREEN

To switch the system on or off:

1. Access the vehicle drawer on your vehicle's touchscreen.
2. Press **SETTINGS**.
3. Press **Driver Assistance**.
4. Press **Pre-Collision Assist**.
5. Switch **Evasive Steering** on or off.

**Note:** If you switch automatic emergency braking off, evasive steering assist turns off.

**Note:** Automatic emergency braking and evasive steering assist turn on every time you switch the power on.

# Pre-Collision Assist

---

## PRE-COLLISION ASSIST – TROUBLESHOOTING

## PRE-COLLISION ASSIST – WARNING LAMPS



A telltale illuminates in the cluster to indicate if the system is disabled or unavailable.

## PRE-COLLISION ASSIST – INFORMATION MESSAGES

<b>Message</b>	<b>Action</b>
Pre-Collision Assist Not Available Sensor Blocked	You have a blocked sensor due to bad weather, ice, mud or water in front of the radar sensor. You can typically clean the sensor to resolve.
Pre-Collision Assist Not Available	A fault with the system has occurred. Have your vehicle checked as soon as possible.

# Pre-Collision Assist

## **PRE-COLLISION ASSIST – FREQUENTLY ASKED QUESTIONS - VEHICLES WITH: INTERSECTION ASSIST**

### **Camera Troubleshooting**

#### **The windshield in front of the camera is dirty or obstructed.**

Clean the outside of the windshield in front of the camera.

#### **The windshield in front of the camera is clean, but the message remains in the instrument cluster display.**

Wait a short time. It could take several minutes for the camera to detect that there is no obstruction.

### **Radar Troubleshooting (If Equipped)**

#### **The surface of the radar in the grille is dirty or obstructed.**

Clean the grille surface in front of the radar or remove the object causing the obstruction.

#### **The surface of the radar in the grille is clean, but the message remains in the instrument cluster display.**

Wait a short time. It could take several minutes for the radar to detect that there is no obstruction.

#### **Heavy rain, spray or fog is interfering with the radar signals.**

The pre-collision assist system is temporarily disabled. Pre-collision assist reactivates a short time after the weather conditions improve.

#### **Swirling water or snow or ice on the surface of the road could interfere with the radar signals.**

The pre-collision assist system is temporarily disabled. Pre-collision assist reactivates a short time after the weather conditions improve.

#### **Radar is out of alignment due to a front end impact.**

Have your vehicle serviced to have the radar checked for proper coverage and operation.

## **PRE-COLLISION ASSIST – FREQUENTLY ASKED QUESTIONS**

### **Camera Troubleshooting**

#### **The windshield in front of the camera is dirty or obstructed.**

Clean the outside of the windshield in front of the camera.

#### **The windshield in front of the camera is clean, but the message remains in the instrument cluster display.**

Wait a short time. It could take several minutes for the camera to detect that there is no obstruction.

### **Radar Troubleshooting (If Equipped)**

#### **The surface of the radar in the grille is dirty or obstructed.**

Clean the grille surface in front of the radar or remove the object causing the obstruction.

#### **The surface of the radar in the grille is clean, but the message remains in the instrument cluster display.**

Wait a short time. It could take several minutes for the radar to detect that there is no obstruction.

#### **Heavy rain, spray or fog is interfering with the radar signals.**

The pre-collision assist system is temporarily disabled. Pre-collision assist reactivates a short time after the weather conditions improve.

# Pre-Collision Assist

---

**Swirling water or snow or ice on the surface of the road is interfering with the radar signals.**

The pre-collision assist system is temporarily disabled. Pre-collision assist reactivates a short time after the weather conditions improve.

**Radar is out of alignment due to a front-end impact.**

Have your vehicle serviced to have the radar checked for proper coverage and operation.

# Driver Alert

## WHAT IS DRIVER ALERT

Driver alert alerts you if it determines that you are becoming drowsy or if your driving deteriorates.

## HOW DOES DRIVER ALERT WORK

Driver Alert calculates your alertness level based on your driving behavior in relation to the lane markings and other factors through use of the front camera sensor behind the interior mirror.

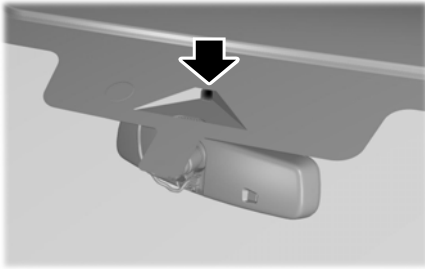

## DRIVER ALERT PRECAUTIONS

**WARNING:** You are responsible for controlling your vehicle at all times. The system is designed to be an aid and does not relieve you of your responsibility to drive with due care and attention. Failure to follow this instruction could result in the loss of control of your vehicle, personal injury or death.

**WARNING:** Take regular rest breaks if you feel tired. Do not wait for the system to warn you.

**WARNING:** Certain driving styles may result in the system warning you even if you are not feeling tired.

**WARNING:** In cold and severe weather conditions the system may not function. Rain, snow and spray can all limit sensor performance.

**WARNING:** The system will not operate if the sensor cannot track the road lane markings.

**WARNING:** If damage occurs in the immediate area surrounding the sensor, have your vehicle checked as soon as possible.

**WARNING:** The system may not correctly operate if your vehicle is fitted with a suspension kit not approved by Ford.

**WARNING:** The system may not operate properly if the sensor is blocked. Keep the windshield free from obstruction.

**Note:** If something is blocking the camera or damaged the windshield, Driver Alert may not function.

## DRIVER ALERT LIMITATIONS

Driver alert may not function correctly if:

- The sensor cannot track the road lane markings.
- Your vehicle's speed is less than approximately 40 mph (65 km/h).

# Driver Alert

## SWITCHING DRIVER ALERT ON AND OFF - VEHICLES WITH: 12.3 INCH SCREEN

1. Press **Features** on the touchscreen.
2. Press **Driver Assistance**.
3. Switch **Driver Alert** on or off.

**Note:** *The system remains on or off depending on how it was last set.*

### Resetting Driver Alert

You can reset the system by either:

- Switching the ignition off and on.
- Opening and closing the driver door when your vehicle is stationary, and it is safe to do so.

## SWITCHING DRIVER ALERT ON AND OFF - VEHICLES WITH: 15 INCH SCREEN

To switch the system on or off, use the touchscreen:

1. Access the vehicle drawer.
2. Press **SETTINGS**.
3. Press **Driver Assistance**.
4. Switch **Driver Alert** on or off.

**Note:** *The system remains on or off depending on how it was last set.*

### Resetting Driver Alert

You can reset the system by either:

- Switching the ignition off and on.
- Stopping the vehicle and then opening and closing the driver door.

## DRIVER ALERT – TROUBLESHOOTING

### DRIVER ALERT – INFORMATION MESSAGES

Message	Action
Driver Alert Warning Rest Now	Stop and rest as soon as it is safe to do so.
Driver Alert Warning Rest Suggested	Take a rest soon.

# Speed Sign Recognition (If Equipped)

## WHAT IS SPEED SIGN RECOGNITION

Speed sign recognition detects speed limit signs to inform you of the current speed limit. Detected speed signs appear in the information display.

## HOW DOES SPEED SIGN RECOGNITION WORK

Speed sign recognition uses a sensor behind the interior mirror to detect speed signs.

If your vehicle has speed sign recognition with navigation, stored speed sign data may influence the indicated speed limit value.

## SPEED SIGN RECOGNITION PRECAUTIONS

 **WARNING:** You are responsible for controlling your vehicle at all times. The system is designed to be an aid and does not relieve you of your responsibility to drive with due care and attention. Failure to follow this instruction could result in the loss of control of your vehicle, personal injury or death.

 **WARNING:** In cold and severe weather conditions the system may not function. Rain, snow and spray can all limit sensor performance.

 **WARNING:** The system may not operate properly if the sensor is blocked. Keep the windshield free from obstruction.

**Note:** Do not carry out windshield repairs in the immediate area surrounding the sensor.

**Note:** If your vehicle has a suspension kit not approved by Ford, the system may not correctly function.

**Note:** The system may not detect all speed signs and may incorrectly read signs.

**Note:** Always fit our original parts when replacing headlamp bulbs. Other bulbs may reduce system performance.

## SPEED SIGN RECOGNITION LIMITATIONS

Speed sign recognition may not operate correctly due to:

- Outdated map data.
- Incorrect recognition of speed limits by the sensor of signs on parallel roads or exit ramps.
- Missed recognition of faded, dirty, or distorted signs.

## SPEED SIGN RECOGNITION INDICATORS



When the system detects a speed limit sign, it appears in the information display.



## Speed Sign Recognition (If Equipped)

---

### SETTING THE SPEED SIGN RECOGNITION SPEED WARNING - VEHICLES WITH: 12.3 INCH SCREEN

To set the speed warning, use the touchscreen.

1. Press **Features** on the touchscreen.
2. Press **Driver Assistance**.
3. Press **Speed Limit Assist**.
4. Switch the feature on or off.

### SETTING THE SPEED SIGN RECOGNITION SPEED WARNING - VEHICLES WITH: 15 INCH SCREEN

To set the speed warning, use the touchscreen.

1. Access the vehicle drawer.
2. Press **SETTINGS**.
3. Press **Driver Assistance**.
4. Press **Speed Limit Assist**.
5. Select to switch the feature on or off.

### SETTING THE SPEED SIGN RECOGNITION SPEED TOLERANCE - VEHICLES WITH: 12.3 INCH SCREEN

To set the tolerance of the speed warning, use the touchscreen.

1. Press **Features** on the touchscreen.
2. Press **Driver Assistance**.
3. Press **Speed Limit Assist**.
4. Press **Tolerance**.
5. Use the slider bar to select the required level.

### SETTING THE SPEED SIGN RECOGNITION SPEED TOLERANCE - VEHICLES WITH: 15 INCH SCREEN

To set the tolerance of the speed warning, use the touchscreen.

1. Access the vehicle drawer.
2. Press **SETTINGS**.
3. Press **Driver Assistance**.
4. Press **Speed Limit Assist**.
5. Press **Tolerance**.
6. Use the slider bar to select the required level.

# Speed Sign Recognition (If Equipped)

---

## SPEED SIGN RECOGNITION – TROUBLESHOOTING

### SPEED SIGN RECOGNITION – INFORMATION MESSAGES

<b>Message</b>	<b>Action</b>
Traffic Sign Reduced Performance See Manual	The traffic sign data provided by the navigation system is unavailable due to weak or no signal. Wait for a short period of time for the signal to improve. If the message continues to appear, have the system checked as soon as possible.

# Speed Sign Recognition (If Equipped)

---

## **SPEED SIGN RECOGNITION – FREQUENTLY ASKED QUESTIONS**

### **Why does the speed limit change without any sign on the road?**

The speed limit changes due to the speed limit data stored in the map data.

### **Why does speed sign recognition show a wrong speed limit?**

The system shows a wrong speed limit due to incorrect and outdated map data or due to incorrect recognition of the speed limits by the camera.

# Load Carrying

## LOAD CARRYING PRECAUTIONS

Keep your loaded vehicle weight within its design rating capability, with or without a trailer. Properly loading your vehicle provides maximum return of vehicle design performance. Before you load your vehicle, become familiar with the following terms for determining your vehicle's weight rating, with or without a trailer, from the vehicle's Tire and Loading Information label or Safety Compliance Certification label.



**WARNING:** Vehicles with a higher center of gravity (utility and four-wheel drive vehicles) handle differently than vehicles with a lower center of gravity (passenger cars). Avoid sharp turns, excessive speed and abrupt steering in these vehicles. Failure to drive cautiously increases the risk of losing control of your vehicle, vehicle rollover, personal injury and death.



**WARNING:** The appropriate loading capacity of your vehicle can be limited either by volume capacity (how much space is available) or by payload capacity (how much weight the vehicle should carry). Once you have reached the maximum

payload of your vehicle, do not add more cargo, even if there is space available. Overloading or improperly loading your vehicle can contribute to loss of vehicle control and vehicle rollover.



**WARNING:** Exceeding the Safety Compliance Certification label vehicle weight limits can adversely affect the performance and handling of your vehicle, cause vehicle damage and can result in the loss of control of your vehicle, serious personal injury or death.



**WARNING:** Do not use replacement tires with lower load carrying capacities than the original tires because they may lower your vehicle's GVWR and GAWR limitations. Replacement tires with a higher limit than the original tires do not increase the GVWR and GAWR limitations.



**WARNING:** Do not exceed the GVWR or the GAWR specified on the certification label.



**WARNING:** Exceeding any vehicle weight rating can adversely affect the performance and handling of your vehicle, cause vehicle damage and can result in the loss of control of your vehicle, serious personal injury or death.

# Load Carrying



**WARNING:** When loading the roof racks, we recommend you evenly distribute the load, as well as maintain a low center of gravity. Loaded vehicles, with higher centers of gravity, may handle differently than unloaded vehicles. Take extra precautions, such as slower speeds and increased stopping distance, when driving a heavily loaded vehicle.

The gross combined weight must never exceed the Gross Combined Weight Rating.

## USING A SLIDE-IN CAMPER

For information regarding the use of slide-in campers, consult the Truck Camper Loading document supplied with your vehicle.

**Note:** We do not recommend using the slide-in camper on a F-150 Lightning.

## LOCATING THE SAFETY COMPLIANCE CERTIFICATION LABELS

### Safety Compliance Certification Label Example:

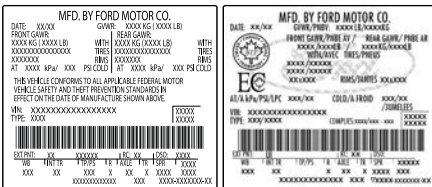

The Safety Compliance Certification label is located on the door hinge pillar, door-latch post, or the door edge that meets the door-latch post, next to the driver seating position.

## WHAT IS THE GROSS AXLE WEIGHT RATING

### GAWR (Gross Axle Weight Rating)

GAWR is the maximum allowable weight that a single axle (front or rear) can carry. These numbers are on the Safety Compliance Certification label.

## WHAT IS THE GROSS VEHICLE WEIGHT RATING

GVWR is the maximum allowable weight of the fully loaded vehicle. This includes all options, equipment, passengers and cargo. It appears on the Safety Compliance Certification label.

## WHAT IS THE GROSS COMBINED WEIGHT RATING

Gross Combined Weight Rating (GCWR) is the maximum allowable weight of the vehicle and the loaded trailer, including all cargo and passengers, that the vehicle can handle without risking damage. (Important: The towing vehicle's braking system is rated for operation at Gross Vehicle Weight Rating, not at Gross Combined Weight Rating.)

## Load Carrying

---

Separate functional brakes should be used for safe control of towed vehicles and for trailers where the Gross Combined Weight of the towing vehicle plus the trailer exceed the Gross Vehicle Weight

Rating of the towing vehicle.

**Note:** For trailer towing information refer to the *RV and Trailer Towing Guide* available at an authorized dealer, or online at the website that follows.

<b>RV &amp; Trailer Towing Guide Online</b>	
Website	<a href="http://www.fleet.ford.com/towing-guides">www.fleet.ford.com/towing-guides</a>

# Load Carrying

## CALCULATING PAYLOAD

### Tire and Loading Label Information

#### Example:



**TIRE AND LOADING INFORMATION**

SEATING CAPACITY NOMBRE DE PLACES	TOTAL : 5	FRONT : 2	REAR : 3
--------------------------------------	-----------	-----------	----------

The combined weight of occupants and cargo should never exceed **385 kg or 850 lbs.**

TIRE	SIZE	COLD TIRE PRESSURE	SEE OWNERS MANUAL FOR ADDITIONAL INFORMATION
FRONT	235/45R18 94V	235 KPA, 34 PSI	
REAR	235/45R18 94V	235 KPA, 34 PSI	
SPARE	NONE	NONE	



**TIRE AND LOADING INFORMATION**  
**RENSEIGNEMENTS SUR LES PNEUS ET LE CHARGEMENT**

SEATING CAPACITY NOMBRE DE PLACES	TOTAL : 5	FRONT AVANT : 2	REAR ARRIERE : 3
--------------------------------------	-----------	--------------------	---------------------

The combined weight of occupants and cargo should never exceed **396 kg or 875 lbs.**  
Le poids total des occupants et du chargement ne doit jamais dépasser

TIRE PNEU	SIZE DIMENSIONS	COLD TIRE PRESSURE PRESSION DES PNEUS A FROID	SEE OWNER'S MANUAL FOR ADDITIONAL INFORMATION  VOIR LE MANUEL DE L'USAGER POUR PLUS DE RENSEIGNEMENTS
FRONT AVANT	235/40R19 96V	255 KPA, 37 PSI	
REAR ARRIERE	235/40R19 96V	255 KPA, 37 PSI	
SPARE DE SECOURS	T125/80R16 97M	415 KPA, 60 PSI	

Payload is the combined weight of cargo and passengers that your vehicle is carrying. The maximum payload for your vehicle appears on the Tire and Loading label. The label is either on the B-pillar or the edge of the driver door. Vehicles exported outside the US and Canada may not have a tire and loading label. Look for "The combined weight of occupants and cargo should never exceed XXX kg or XXX lb" for maximum payload. The payload listed on the Tire and Loading Information label

is the maximum payload for your vehicle as built by the assembly plant. If you install any additional equipment on your vehicle, you must determine the new payload. Subtract the weight of the equipment from the payload listed on the Tire and Loading label. When towing, trailer tongue weight or king pin weight is also part of payload.

## CALCULATING THE LOAD LIMIT

Steps for determining the correct load limit:

1. Locate the statement "The combined weight of occupants and cargo should never exceed XXX kg or XXX lb." on your vehicle's placard.
2. Determine the combined weight of the driver and passengers that will be riding in your vehicle.
3. Subtract the combined weight of the driver and passengers from XXX kg or XXX lb.
4. The resulting figure equals the available amount of cargo and luggage load capacity. For example, if the "XXX" amount equals 1,400 lb. and there will be five 150 lb. passengers in your vehicle, the amount of available cargo and luggage load capacity is 650 lb. (1400-750 (5 x 150) = 650 lb.)

## Load Carrying

---

- Determine the combined weight of luggage and cargo being loaded on the vehicle. That weight may not safely exceed the available cargo and luggage load capacity calculated in Step 4.
- If your vehicle will be towing a trailer, load from your trailer will be transferred to your vehicle. Consult this manual to determine how this reduces the available cargo and luggage load capacity of your vehicle.

### Helpful examples for calculating the available amount of cargo and luggage load capacity

Suppose your vehicle has a 1400-pound (635-kilogram) cargo and luggage capacity. You decide to go golfing. Is there enough load capacity to carry you, four of your friends and all the golf bags? You and four friends average 220 pounds (99 kilograms) each and the golf bags weigh approximately 30 pounds (13.5 kilograms) each. The calculation would be:  $1400 - (5 \times 220) - (5 \times 30) = 1400 - 1100 - 150 = 150$  pounds. Yes, you have enough load capacity in your vehicle to transport four friends and your golf bags. In metric units, the calculation would be:  $635 \text{ kilograms} - (5 \times 99 \text{ kilograms}) - (5 \times 13.5 \text{ kilograms}) = 635 - 495 - 67.5 = 72.5$  kilograms.

Suppose your vehicle has a 1400-pound (635-kilogram) cargo and luggage capacity. You and one of your friends decide to pick up cement from the local home improvement store to finish that patio you have been planning for the past two years. Measuring the inside of the vehicle with the rear seat folded down, you have room for twelve 100-pound (45-kilogram) bags of cement. Do you have enough load capacity to transport the cement to your home? If you and your friend each weigh 220 pounds (99 kilograms), the calculation would be:  $1400 - (2 \times 220) - (12 \times 100) = 1400 - 440 - 1200 = -240$  pounds. No, you do not have enough cargo capacity to carry that much weight. In metric units, the calculation would be:  $635 \text{ kilograms} - (2 \times 99 \text{ kilograms}) - (12 \times 45 \text{ kilograms}) = 635 - 198 - 540 = -103$  kilograms. You will need to reduce the load weight by at least 240 pounds (104 kilograms). If you remove three 100-pound (45-kilogram) cement bags, then the load calculation would be:  $1400 - (2 \times 220) - (9 \times 100) = 1400 - 440 - 900 = 60$  pounds. Now you have the load capacity to transport the cement and your friend home. In metric units, the calculation would be:  $635 \text{ kilograms} - (2 \times 99 \text{ kilograms}) - (9 \times 45 \text{ kilograms}) = 635 - 198 - 405 = 32$  kilograms.



## Load Carrying

---

The above calculations also assume that the loads are positioned in your vehicle in a manner that does not overload the front or the rear gross axle weight rating specified for your vehicle on the Safety Compliance Certification label.

# Luggage Compartment

## LUGGAGE COMPARTMENT PRECAUTIONS



**WARNING:** Keep vehicle doors and luggage compartment locked and keep keys and remote transmitters out of a child's reach. Unsupervised children could lock themselves in the luggage compartment and risk injury. Children should be taught not to play in vehicles.

**Note:** The frunk only operates when the vehicle is in park (P). If there is a problem with the open or close request, a tone sounds and a warning message appears in the instrument cluster.

**Note:** Do not hang any weight from the frunk. This could damage the frunk and its components. Remove any excessive weight from the frunk prior to use. If the frunk starts to close after it has fully opened, this indicates there may be excessive weight on the frunk or a possible strut failure. A repetitive tone sounds and the frunk closes under control. If the frunk continues to close after opening, have the system checked.

**Note:** Do not leave the frunk open while driving. This could damage the frunk and its components.

## OPENING THE FRUNK

### OPENING THE FRUNK FROM INSIDE YOUR VEHICLE



**WARNING:** People should never climb inside the luggage compartment. Never shut the luggage compartment when a person is inside.

**Note:** Make sure the vehicle is in park (P).

### Using the Instrument Panel Button



Press the button to open the frunk.

### Using the Touchscreen

1. Access the vehicle drawer on the touchscreen.
2. Press **CONTROLS**.
3. Press **Access**.
4. Press the frunk icon.



### Manually Opening the Frunk

**Note:** It is recommended that you only operate the frunk manually when the vehicle battery runs out of charge or the power frunk is faulty.

**Note:** Do not pull the service release strap if the vehicle is not in park (P).

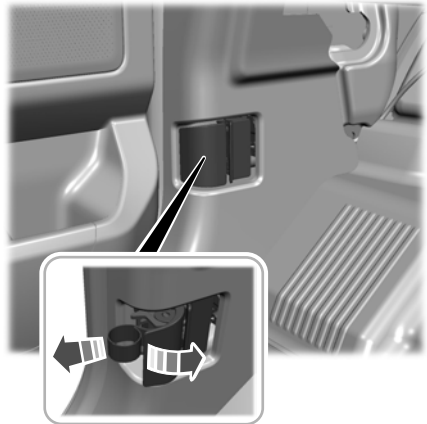

1. Open the left-hand front door.
2. Open the access door.

# Luggage Compartment

3. Pull the service release strap from the panel to release the primary latch.
4. Pull the service release strap again to release the frunk.
5. Lift the frunk. The struts support the frunk.

## OPENING THE FRUNK FROM OUTSIDE YOUR VEHICLE

**Note:** Allow the power system to open the frunk. Manually pushing or pulling the frunk may activate the system's obstacle detection feature and stop the power operation or reverse its direction, replicate a strut failure or damage mechanical components.

**Note:** Be careful when opening the frunk in a garage or other enclosed area to avoid damaging the frunk.

## Using Frunk Control Button

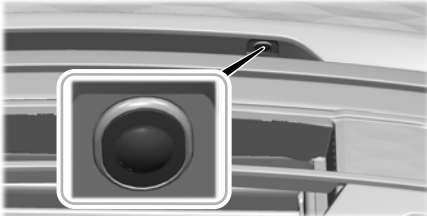

Press and release the control button.

## Using the Keyless Entry Keypad



Enter the factory set code or your personal code, then press **7•8** on the keypad within five seconds.

## Using Phone as a Key

Press the button to open the frunk.

**Note:** Make sure the authorized phone is within 3 ft (1 m) of the vehicle.

## OPENING THE FRUNK USING THE REMOTE CONTROL



Press the button twice within three seconds.

**Note:** Be careful when opening the frunk in a garage or other enclosed area to avoid damaging the frunk.

## SETTING THE FRUNK OPENING HEIGHT

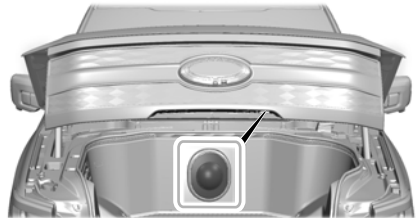

# Luggage Compartment

1. Open the frunk.
2. Stop the frunk movement by pressing the control button when it reaches the desired height.

**Note:** Once the frunk stops moving, you can manually move it to the desired height.

3. Press and hold the control button until a tone sounds, indicating programming is complete.

**Note:** You cannot program the height if the frunk position is too low.

**Note:** You can only use the control button to program the height at the moment.

4. The frunk now opens at the programmed height. To change the programmed height, repeat the steps.

**Note:** You can fully open the frunk by manually pushing it upward to the maximum open position if it opens in a lower position.

**Note:** The system recalls the new programmed height until you reprogram it, even if you disconnect the battery.

## CLOSING THE FRUNK

### CLOSING THE FRUNK FROM INSIDE YOUR VEHICLE

**Note:** A tone sounds when the frunk begins to close.

**Note:** Make sure the vehicle is in park (P).

### Using the Instrument Panel Button



Press the button to close the frunk.

### Using the Touchscreen

1. Access the vehicle drawer on the touchscreen.
2. Press **CONTROLS**.

3. Press **Access**.



5. Press the frunk icon.

## CLOSING THE FRUNK FROM OUTSIDE YOUR VEHICLE

**Note:** A tone sounds when the frunk begins to close.

**Note:** Before driving off, check the instrument cluster for a frunk ajar message or warning indicator. Failure to do this could result in unintentionally leaving the frunk open while driving.

## Using Frunk Control Button



Press and release the control button.

## Using Phone as a Key

Press the button to close the frunk.

## Manually Closing the Frunk

**Note:** It is recommended that you only operate the frunk manually when the vehicle battery runs out of charge or the power frunk is faulty.

Lower the frunk and apply light pressure as it drops.

# Luggage Compartment

## CLOSING THE FRUNK USING THE REMOTE CONTROL



Press the button twice within three seconds.

## STOPPING THE FRUNK MOVEMENT

**Note:** Do not apply sudden excessive force to the frunk while it is in motion. This could damage the power frunk and its components.

**Note:** Selections vary depending on region or options.

You can stop the frunk movement by pressing the control button on any of the following:

- Frunk.
- Instrument panel.
- Remote control twice.
- Authorized phone as a key.
- Touchscreen.

## FRUNK OBSTACLE DETECTION

### Opening the Frunk

The system stops and a tone sounds when it detects an obstacle. Once you remove the obstacle, you can continue to operate the frunk.

### Closing the Frunk

The system stops, a tone sounds and the system reverses to open when it detects an obstacle. Once you remove the obstacle, you can close the frunk.

**Note:** Loading the cargo area while the frunk is closing can cause your vehicle to bounce and activate obstacle detection.

The system is designed with pressure sensing pinch strips to detect when an obstacle is in the way of the frunk.

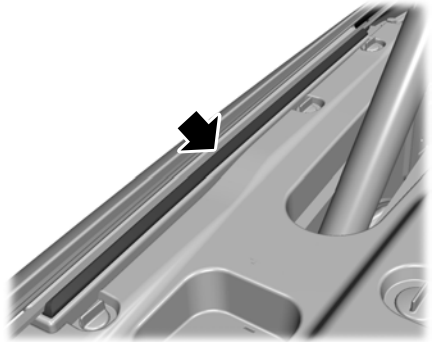

The system stops and reverses the direction of the frunk when it detects an obstacle pressing on the pinch strips. Once you remove the obstacle you can operate the frunk.

**Note:** Before driving off, check the instrument cluster for a frunk ajar message or warning indicator. Failure to do this could result in unintentionally leaving the frunk open while driving.

# Luggage Compartment

## USING THE FRUNK EMERGENCY RELEASE



If you are stuck inside the frunk, press the interior release button to open it. The material around the switch glows after a brief exposure to ambient light.

**Note:** If the switch is pressed but the frunk cannot be opened due to a system error, a tone sounds and a warning message appears in the instrument cluster.

## INSTALLING AND REMOVING THE LUGGAGE COMPARTMENT COVER

Remove the front luggage compartment covers in the following order:

1. Rear left-hand.
2. Rear right-hand.
3. Left-hand side.
4. Right-hand side.

## Removing the Rear Left-Hand Cover

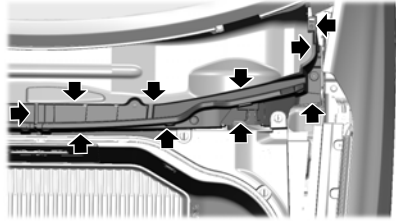

1. Start at the rear edge of the left-hand side.
2. Pull upward at the clip locations shown to release the clips.
3. Remove the cover.
4. To install, reverse the removal procedure.

## Removing the Rear Right-Hand Cover

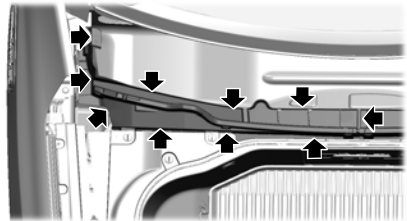

1. Start at the rear edge of the right-hand side.
2. Pull upward at the clip locations shown to release the clips.
3. Remove the cover.
4. To install, reverse the removal procedure.

# Luggage Compartment

## Removing the Left-Hand Side Cover

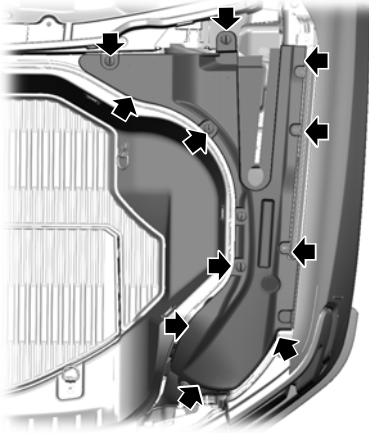

1. Start at the rear edge of the left-hand side and work toward the front of the cover.
2. Pull upward at the clip locations shown to release the clips.
3. Remove the cover.
4. To install, reverse the removal procedure.

## Removing the Right-Hand Side Cover

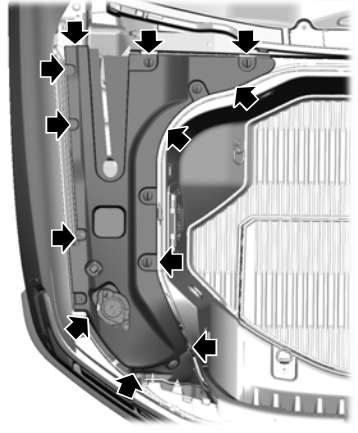

1. Start at the rear edge of the right hand-side and work toward the front of the cover.
2. Pull upward at the clip locations shown to release the clips.
3. Remove the cover.
4. To install, reverse the removal procedure.

# Luggage Compartment

## ADJUSTING THE LUGGAGE COMPARTMENT LOAD FLOOR

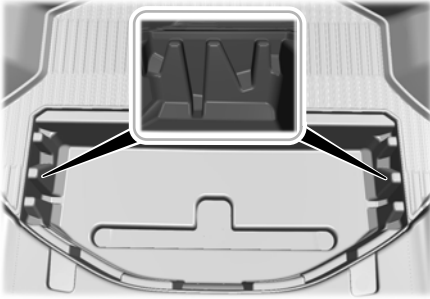

The front luggage compartment has molded slots designed to fit the load floor divider to create flexible options for the cargo.

Lift the load floor divider and slide it into any molded slot as needed.

**Note:** Make sure that you properly balance and secure the cargo load. Failure to do this can cause cargo instability and damage to the load floor divider.

## LUGGAGE COMPARTMENT ANCHOR POINTS

### LOCATING THE LUGGAGE COMPARTMENT ANCHOR POINTS

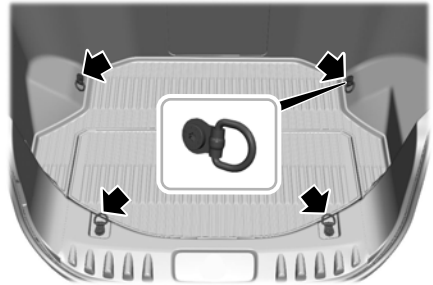

## LUGGAGE COMPARTMENT – TROUBLESHOOTING

### LUGGAGE COMPARTMENT – WARNING LAMPS



Illuminates when the the ignition is on and the frunk is not completely closed.



# Luggage Compartment

## LUGGAGE COMPARTMENT – INFORMATION MESSAGES

Message	Action
Frunk ajar	Displays to remind you that the frunk is not completely closed.
Frunk ajar Stop safely Close frunk	Displays to remind you that the frunk is not completely closed. Stop your vehicle in a safe place. Close the frunk completely before continuing to drive.
Frunk System fault Service required	The system has detected a fault that requires service. Open the frunk, using the service release strap if power operation is not available. Make sure the cargo is properly stowed and nothing is pressing the emergency release switch. If the message continues to appear, have your vehicle checked as soon as possible.
Frunk emergency release activated Check frunk contents	The emergency release button inside the frunk is turned on. Open the frunk and inspect the contents. Make sure the cargo is properly stowed and nothing is pressing the emergency release switch. If the message continues to appear, have your vehicle checked as soon as possible. See <b>Using the Frunk Emergency Release</b> (page 338).

# Luggage Compartment

---

## LUGGAGE COMPARTMENT – FREQUENTLY ASKED QUESTIONS

### Why won't my power frunk open?

Make sure the vehicle is in park (P), and there is nothing obstructing the frunk path or causing resistance. For example, aftermarket accessory, freezing conditions or being parked downhill. If you have continued issues, the battery voltage may be low or other system issues. Have your vehicle checked.

### Why won't my power frunk close?

Make sure nothing is obstructing the frunk path or causing resistance. Remove the obstacles to resume normal operation. If you have continued issues, the battery voltage may be low or other system issues. Have your vehicle checked.

### Why does my power frunk stop when opening?

The system is equipped with active obstacle detection via the powered struts to detect when an obstacle is in the way of the frunk. The system stops the movement of the frunk when it detects an obstacle. Remove the obstacles to resume normal operation. See **Frunk Obstacle Detection** (page 337).

### Why does my power frunk reverse its direction when closing?

The system is designed with pressure sensing pinch strips to detect when an obstacle is in the way of the frunk. The system stops and reverses the direction of the frunk when it detects an obstacle pressing on the pinch strips. Remove the obstacles to resume normal operation. See **Frunk Obstacle Detection** (page 337).

# Pickup Bed

## PICKUP BED PRECAUTIONS



**WARNING:** Do not allow people or animals in truck beds that have modifications, such as bed covers or slide-in campers, when the engine is running. Exhaust fumes are toxic. Failure to follow this instruction could result in personal injury or death.



**WARNING:** It is extremely dangerous to ride in a cargo area, inside or outside of a vehicle. In a crash, people riding in these areas are more likely to be seriously injured or killed. Do not allow people to ride in any area of your vehicle that is not equipped with seats and seatbelts. Make sure everyone in your vehicle is in a seat and properly using a seatbelt. Failure to follow this warning could result in serious personal injury or death.

## PICKUP BED ANCHOR POINTS

### PICKUP BED ANCHOR POINT PRECAUTIONS



**WARNING:** Always properly secure cargo to prevent shifting cargo or cargo falling from the vehicle. Failure to do so could result in compromised vehicle stability and serious personal injury to vehicle occupants or others.



**WARNING:** The appropriate loading capacity of your vehicle can be limited either by volume capacity (how much space is available) or by payload capacity (how much weight the vehicle should carry). Once you have reached

the maximum payload of your vehicle, do not add more cargo, even if there is space available. Overloading or improperly loading your vehicle can contribute to loss of vehicle control and vehicle rollover.



**WARNING:** It is extremely dangerous to ride in a cargo area, inside or outside of a vehicle. In a crash, people riding in these areas are more likely to be seriously injured or killed. Do not allow people to ride in any area of your vehicle that is not equipped with seats and seatbelts. Make sure everyone in your vehicle is in a seat and properly using a seatbelt. Failure to follow this warning could result in serious personal injury or death.



**WARNING:** Do not use the load retaining fixtures for towing. Failure to follow this instruction could result in personal injury.



**WARNING:** Do not exceed the maximum load rating of the load retaining fixtures. Failure to follow this instruction could result in personal injury.



**WARNING:** Check the load retaining fixtures for damage before using them. Failure to follow this instruction could result in personal injury.

## INSTALLING AND REMOVING THE PICKUP BED TIE-DOWN CLEATS

(If Equipped)

### Installing the Cleats

1. Insert the key into the lock and turn clockwise to unlock.
2. Insert the cleat into the pickup bed anchor point and slide upward.
3. Turn the key counterclockwise to lock.

# Pickup Bed

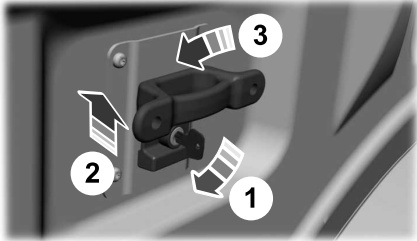
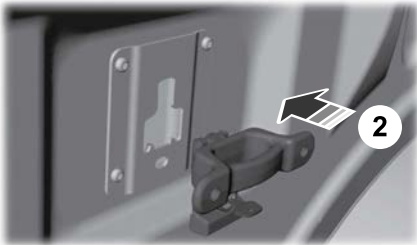

## PICKUP BED ANCHOR POINT LOAD CAPACITIES

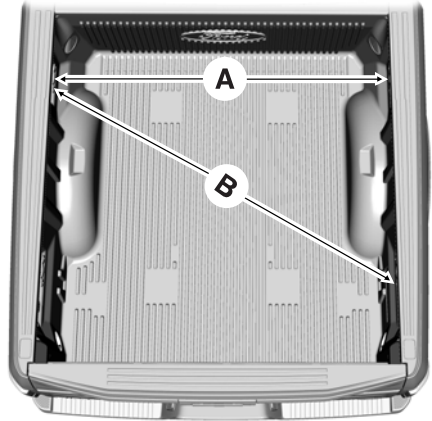

A	B
Maximum force between directly opposed cleats 276 lb (125 kg).	Maximum force between diagonally opposed cleats 600 lb (272 kg).

**Note:** Leave the key in the lock when removing or installing the cleats. The key cannot be removed unless it is in the locked position.

### Removing the Cleats

To remove, reverse the installation procedure.

**Note:** You could damage the pickup bed walls if you overload the tie downs.

**Note:** Make sure that you properly balance and secure the cargo load. Failure to do this can cause cargo instability and damage to the box.

**Note:** Do not secure cargo with tie downs connected from the tie down brackets to the cargo box tie downs. This could cause the tailgate to detach.

# Pickup Bed

## TAILGATE ANCHOR POINTS

### LOCATING THE TAILGATE ANCHOR POINTS

The tailgate anchor points are located at each side of the tailgate.

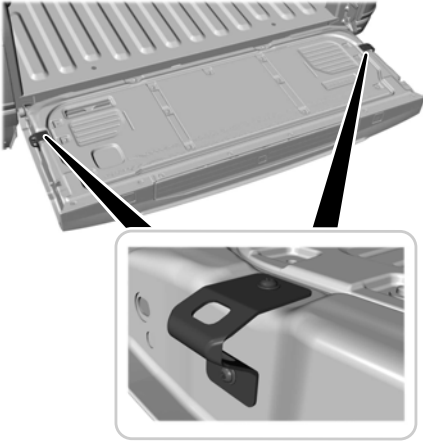

**Note:** You could damage the tailgate if you overload the tie downs.

### TAILGATE ANCHOR POINT LOAD CAPACITIES

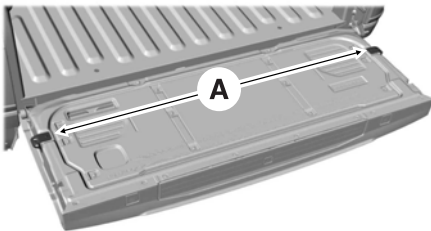

A
The maximum force between the tailgate anchor points 400 lb (181 kg).

**Note:** Do not secure cargo from a pickup bed anchor point to a tailgate anchor point. This could cause the tailgate to detach.

## PICKUP BED RAMPS

### PICKUP BED RAMP PRECAUTIONS

**WARNING:** When sliding the ramp up or down, take care not to get your fingers or hands caught in the mechanism. Failure to follow this instruction could result in personal injury.

**WARNING:** Make sure that you correctly install the ramp to the tailgate plate. Failure to follow this instruction could result in personal injury.

**WARNING:** Do not step or sit on the ramp when it is in the stowed position. Failure to follow this instruction could result in personal injury.

**WARNING:** Only install the ramp within the prescribed ramp angles. Failure to follow this instruction could result in personal injury.

**Note:** Each pickup bed ramp has a maximum capacity of 400 lb (181.4 kg).

**Note:** Verify the ramp is on stable ground before usage.

# Pickup Bed

**Note:** For loading and unloading equipment, your ramp should be set between 10 degrees upward and 26 degrees downward to avoid damage to the ramp claw and tailgate plate.

**Note:** When using your vehicle for off-road operation, remove the bed ramps from the vehicle and store them in a safe location away from your vehicle.

## INSTALLING AND REMOVING THE PICKUP BED RAMP HOLDER

### Installing the Ramp Holder

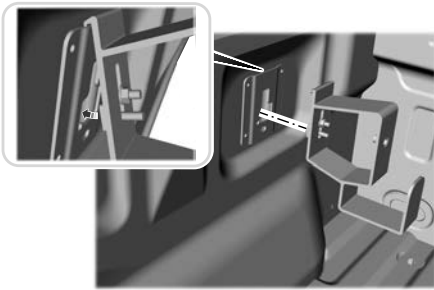

1. Hook the top of the ramp holder over the mounting plate and rotate the ramp holder into position.

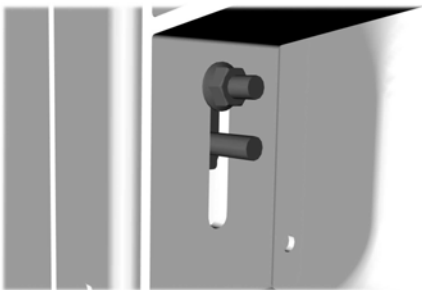

2. Slide the ramp holder studs upwards into the installed position.

3. Tighten the ramp holder nut.

**Note:** The nut should be on the upper stud.

### Removing the Ramp Holder

Remove in the reverse order.

## INSTALLING AND REMOVING THE PICKUP BED RAMPS

**Note:** You cannot use the pickup bed ramps with the tailgate work surface or tailgate step.

### Installing the Bed Ramp

1. Remove the front and rear cables.

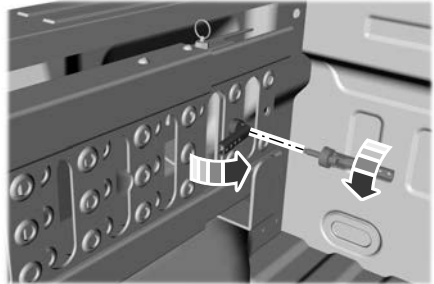

2. Open the cam lever arms and unscrew the cam bolts.
3. Remove the ramp from the ramp holder.



# Pickup Bed

4. Rotate the stops at the underside of the ramp to the open position.

**Note:** You can use a smooth surface tool to rotate the stops.

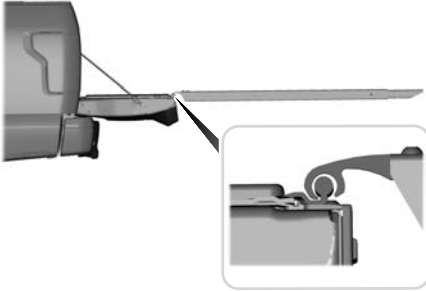

5. Slide the ramp claw onto the tailgate plate.

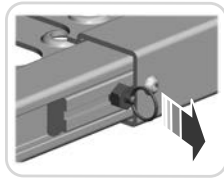

6. Pull the location pin outward and extend the ramp until the pin is seated in the usage position, then set the ramp on even ground.

## Removing the Ramp

Remove in the reverse order.

## STORING THE PICKUP BED RAMPS

### Storing the Bed Ramp

1. Pick up the ramp. Pull the location pin outward.
2. Slide the ramp into the storage position until the location pin locks.

**Note:** Make sure the proper pin location has been applied for your bed size.

3. Slide the ramp claw off of the tailgate plate.
4. Rotate the stops at the underside of the ramp to the closed position.

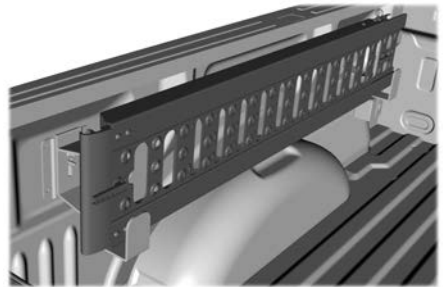

5. Place the ramp into the ramp holder.
6. Install the cam bolts and close the cam lever arms.
7. Attach the front and rear cables.

**Note:** Make sure you properly secure the locking cable. If the locking cable is unsecured, you may hear a rattling noise.

# Connecting a Trailer

## CONNECTING A TRAILER PRECAUTIONS

Do not tow a trailer until you drive your vehicle at least 1,000 mi (1,600 km).

Consult your local motor vehicle laws for towing a trailer.

See the instructions included with towing accessories for the proper installation and adjustment specifications.

Service your vehicle more frequently if you tow a trailer. See **Normal Scheduled Maintenance** (page 563).

If you use a rental trailer, follow the instructions the rental agency gives you.

When attaching the trailer wiring connector to your vehicle, only use a proper fitting connector that works with the vehicle and trailer functions.

Account for the trailer coupler weight as part of your vehicle load when calculating the total vehicle weight.

Do not exceed the load limits. See **Calculating the Load Limit** (page 331).

## HITCHES

### HOOKING UP A TRAILER USING A WEIGHT-DISTRIBUTING HITCH



**WARNING:** Do not adjust the spring bars so that your vehicle's rear bumper is higher than before attaching the trailer. Doing so will defeat the function of the weight-distributing hitch, which may cause unpredictable handling, and could result in serious personal injury.

A weight-distributing hitch helps distribute tongue load to all towing vehicle and trailer wheels. For more information, visit the links in the following table.

Market	Website
United States of America	<a href="https://www.fleet.ford.com/towing-guides/">https://www.fleet.ford.com/towing-guides/</a>
Canada	<a href="https://www.fleet.ford.ca/towing-guides/">https://www.fleet.ford.ca/towing-guides/</a>

## CONNECTING A TRAILER

### Recognizing a Trailer

1. Attach the trailer and wiring connector to your vehicle.
2. Switch on your vehicle.
3. Set up a profile for the trailer using the touchscreen.

**Note:** If your vehicle does not recognize the trailer, press and hold the brake pedal for a few seconds.

**Note:** Trailer profiles store trailer types, dimensions, preferences, trailer specific mileage and range estimation.

**Note:** Disabling the trailer detection notification makes the default trailer profile active when a connection is detected.



# Connecting a Trailer



When attaching the trailer wiring connector to your vehicle, only use a proper fitting connector that works with the vehicle and trailer functions.

## Safety Chains

Install trailer safety chains to the trailer hitch as recommended by the manufacturer. Cross the chains under the trailer coupler and allow enough slack for turning tight corners. Do not allow the chains to drag on the ground.

**Note:** Do not attach safety chains to the bumper. Always connect the safety chains to the frame or hook retainers of your trailer hitch.

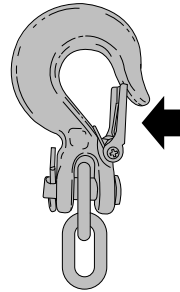

If the trailer safety chain hook has a latch, make sure the latch is fully closed.

## Trailer Connection Checklist

1. Press **Features** on the touchscreen.
2. Press **Towing**.
3. Press **Connection Checklist**.

## Electronic Park Hold



Applies the electronic parking brake when you shift into park (P).

The electronic park hold button illuminates when activated.

The feature prevents your vehicle from moving in any direction when you are aligned with your trailer coupler and shift into park (P).

**Note:** The feature is active for the current key cycle.

You can also press a zoom button when using the camera views to switch the feature on.

## Trailer Connection Alarm

The alarm is set when the following occur:

- Your vehicle detects the trailer.
- Your vehicle is locked.
- The alarm is armed.

# Connecting a Trailer

When the trailer is disconnected in this state, the vehicle alarm sounds and an alert is sent to your FordPass app.

**Note:** For reliable trailer detection, the trailer's lamps must be SAE certified for each intended purpose.

**Note:** If the trailer is not compatible with the feature, the turn signals flash twice.

## Switching the Trailer Connection Alarm On and Off

1. Press **Features** on the touchscreen.
2. Press **Towing**.
3. Press **Manage trailers**.
4. Press the currently active trailer's name.
5. Switch **Trailer Connection Alarm** on or off.

**Note:** The alarm disables by default. If the system detects a trailer, it can be configurable.

**Note:** Settings are applicable only for the selected trailer profile.

## Trailer Connector Battery Lead

The trailer receives power from the vehicle trailer connector battery lead when the following occurs:

- Your vehicle is in accessory mode or switched on.
- The trailer wiring connector is free of corrosion or other damage.

- The vehicle battery is not low.
- When the trailer has a battery:
  - The trailer battery voltage is within 5 volts of the vehicle battery voltage.
  - When you have the trailer battery properly connected.

## TRAILER LIGHTING CHECK



**WARNING:** Never connect any trailer lamp wiring to the vehicle's tail lamp wiring; this may damage the electrical system resulting in fire. Contact your authorized dealer as soon as possible for assistance in proper trailer tow wiring installation. Additional electrical equipment may be required.

Perform a trailer light illumination sequence to confirm that all lights are functioning by using the FordPass app or vehicle's touchscreen.

## Performing the Trailer Lighting Check Using the Touchscreen

1. Press **Features** on the touchscreen.
2. Press **Towing**.
3. Press **Trailer Light Check**.
4. Press **Start**.

# Connecting a Trailer

## CONNECTING A TRAILER – TROUBLESHOOTING

### CONNECTING A TRAILER – INFORMATION MESSAGES

<b>Message</b>	<b>Description</b>
Trailer Disconnected	The system senses a trailer connection becomes disconnected, either intentionally or unintentionally, during a given ignition cycle.
Trailer Wiring Fault	There are certain faults in your vehicle wiring and trailer wiring or brake system.
Trailer Battery Not Charging See Manual	There is a fault with your trailer battery, or your trailer battery voltage is very low.
Trailer Tire Low Specified:	One or more tires on your trailer is below the specified tire pressure.
Trailer Tire Over Temperature	Displays when one or more tires on the trailer is above the recommended temperature.
Trailer Tire Pressure Sensor Fault	A trailer tire pressure sensor is malfunctioning. If the warning stays on or continues to come on, have the system checked as soon as possible.
Trailer Tire Pressure Monitor Fault	The trailer tire pressure monitoring system is malfunctioning. If the warning stays on or continues to come on, have the system checked.
Trailer Tire Pressure Monitor Capability Not Detected	The system cannot detect the trailer tire pressure monitoring system.
Trailer Tire Pressure Indication Not Setup See Manual	The trailer tire pressure monitoring system is not setup.

# Towing a Trailer

## TOWING A TRAILER PRECAUTIONS

 **WARNING:** Do not exceed the GVWR or the GAWR specified on the certification label.

 **WARNING:** Towing trailers beyond the maximum recommended gross trailer weight exceeds the limit of your vehicle and could result in vehicle damage, loss of vehicle control, vehicle rollover and personal injury.

 **WARNING:** Do not exceed the lowest rating capacity for your vehicle or trailer hitch. Overloading your vehicle or trailer hitch can impair your vehicle stability and handling. Failure to follow this instruction could result in the loss of control of your vehicle, personal injury or death.

 **WARNING:** Make sure that the vertical load on the tow ball is between the minimum and maximum recommended weight at all times. Failure to follow this instruction could result in the loss of control of your vehicle, personal injury or death.

 **WARNING:** Do not cut, drill, weld or modify the trailer hitch. Modifying the trailer hitch could reduce the hitch rating.

 **WARNING:** The anti-lock brake system does not control the trailer brakes.

## TRAILER BRAKE PRECAUTIONS

 **WARNING:** Do not connect a trailer's hydraulic brake system directly to your vehicle's brake system. Your vehicle may not have enough braking power and your chances of having a collision greatly increase.

 **WARNING:** Do not tow a trailer fitted with electric trailer brakes unless your vehicle is fitted with a compatible electronic trailer brake controller. Failure to follow this instruction could result in the loss of control of your vehicle, personal injury or death. For additional information and assistance, we recommend that you contact an authorized dealer.

Electric brakes and manual, automatic or surge-type trailer brakes are safe if you install them properly and adjust them to the manufacturer's specifications. The trailer brakes must meet local and federal regulations.

The rating for the tow vehicle's braking system operation is at the gross vehicle weight rating, not the gross combined weight rating.

# Towing a Trailer

---

Certain states require functioning trailer brakes for trailers over a specified weight. Be sure to check state regulations for this specified weight.

Ford Motor Company recommends separate functioning brake systems for trailers weighing more than 1,500 lb (680 kg) when loaded.

## TOWING A TRAILER LIMITATIONS

The vehicle's load capacity designation is by weight, not by volume, so you cannot necessarily use all available space when loading a vehicle or trailer.

## LOADING YOUR TRAILER

To help minimize how trailer movement affects your vehicle when driving:

- Load the heaviest items closest to the trailer floor.
- Load the heaviest items centered between the left and right side trailer tires.

- Load the heaviest items above the trailer axles or just slightly forward toward the trailer tongue. Do not allow the final trailer tongue weight to go above or below 10-15% of the loaded trailer weight. The trailer tongue weight should never exceed 10% of the maximum towing capacity.
- Select a ball mount with the correct rise or drop. When both the loaded vehicle and trailer are connected, the trailer frame should be level, or slightly angled down toward your vehicle, when viewed from the side.

## TRAILER TOWING HINTS

Towing a trailer places an extra load on your vehicle's driveline, brakes, tires and suspension. Periodically inspect these components during and after any towing operation.

When driving with a trailer or payload, a slight takeoff vibration or shudder may be present due to the increased payload weight.

Your vehicle may have a temporary or conventional spare tire. A temporary spare tire is different in diameter or width, tread-type, or is from a different manufacturer than the road tires on your vehicle. Consult information on the tire label or Safety Compliance label for limitations when using.

When towing a trailer:

- Obey country specific regulations for towing a trailer.
- Do not tow for the first 500 mi (800 km).

# Towing a Trailer

- Do not make full-throttle starts.
- Check your hitch, electrical connections and trailer wheel lug nuts thoroughly after you have traveled 50 mi (80 km).
- Turn off the speed control with heavy loads or in hilly terrain. The speed control may turn off when you are towing on long, steep slopes.
- Use the Tow/Haul drive mode to control speed with additional regenerative braking. Do not continuously apply the brakes, as they may overheat and become less effective.
- Your vehicle has AdvanceTrac with roll stability control. When towing a trailer, additional loads could cause the AdvanceTrac system to engage during cornering maneuvers. Reduce cornering speeds to make sure that you can maintain control of the vehicle and trailer if the AdvanceTrac system engages.
- Allow more distance for stopping with a trailer attached. Anticipate stops and gradually brake.
- Avoid parking on a slope. However, if you must park on a slope, turn the steering wheel to point your vehicle tires away from traffic flow, set the parking brake, place the transmission in park (P) and place wheel chocks in front and back of the trailer wheels.

**Note:** Chocks are not included with your vehicle.

## LAUNCHING OR RETRIEVING A BOAT OR PERSONAL WATERCRAFT

When backing down a ramp during boat launching or retrieval:

- Do not allow the static water level to rise above the bottom edge of the rear bumper.
- Do not allow waves to break higher than 6 in (15 cm) above the bottom edge of the rear bumper.

Exceeding 6 in (15 cm) could allow water to enter vehicle components, causing internal damage to the components and affecting driveability, emissions and reliability.

**Note:** Disconnect the trailer wiring connector before backing the trailer into the water.

**Note:** Reconnect the trailer wiring connector after removing the trailer from the water.

## TOWING WEIGHTS AND DIMENSIONS

### RECOMMENDED TOWING WEIGHTS

Market	Website
United States of America	<a href="https://www.fleet.ford.com/towing-guides/">https://www.fleet.ford.com/towing-guides/</a>
Canada	<a href="https://www.fleet.ford.ca/towing-guides/">https://www.fleet.ford.ca/towing-guides/</a>

# Towing a Trailer

---

## WHAT IS THE MAXIMUM LOADED TRAILER WEIGHT

The maximum loaded trailer weight is the highest possible weight of a fully loaded trailer the vehicle can tow.

## CALCULATING THE MAXIMUM LOADED TRAILER WEIGHT FOR YOUR VEHICLE

1. Start with the gross combined weight rating for your vehicle model and axle ratio.
2. Subtract all of the following that apply to your vehicle:
  - Vehicle curb weight.
  - Hitch hardware weight, for example a draw bar, ball, locks or weight distributing hardware.

- Driver weight.
- Passenger weight.
- Payload, cargo and luggage weight.
- Aftermarket equipment weight.

This equals the maximum loaded trailer weight for this combination.

**Note:** *The trailer tongue load is considered part of the payload for your vehicle. Reduce the total payload by the final trailer tongue weight.*

**Note:** *Consult an authorized dealer to determine the maximum trailer weight allowed for your vehicle if you are not sure.*

# Towing a Trailer

## TOWING A TRAILER – TROUBLESHOOTING

### TOWING A TRAILER – INFORMATION MESSAGES

<b>Message</b>	<b>Details</b>
Trailer Left Turn Lamps Fault Check Lamps	The left-hand trailer turn lamp requires service.
Trailer Right Turn Lamps Fault Check Lamps	The right-hand trailer turn lamp requires service.
Trailer Battery Not Charging See Manual	The trailer battery voltage is too low to charge.
Trailer Lighting Module Fault See Manual	The system detects a short created by the trailer lamps. Inspect and repair the trailer wiring, or have the system checked as soon as possible.
Trailer Stop Lamps Fault Check Lamps	The trailer stoplamps require service.
Trailer brake system fault See manual	Verify the trailer brake connections are secure and that the aftermarket trailer brake controller device is correctly installed. Perform a trailer brake and trailer light check if possible. If the message persists, have your vehicle checked as soon as possible.
Trailer brake module fault	Perform a trailer brake and trailer light check if possible. If the message persists, have your vehicle checked as soon as possible.
Trailer Sway Reduce Speed	The trailer sway control detects trailer sway. Reduce the vehicle's speed.
Trailer Tire Over Temperature	Displays when one or more tires on the trailer is above the recommended temperature.
Trailer Tire Low Specified:	One or more tires on your trailer is below the specified tire pressure.
Trailer Tire Pressure Sensor Fault	A trailer tire pressure sensor requires service. If the warning stays on or continues to come on, have the system checked as soon as possible.



# Towing a Trailer

---

<b>Message</b>	<b>Details</b>
Trailer Tire Pressure Monitor Fault	The trailer tire pressure monitoring system requires service. If the warning stays on or continues to come on, have the system checked as soon as possible.
Trailer Tire Pressure Monitor Capability Not Detected	The system cannot detect the trailer tire pressure monitoring system.
Trailer Tire Pressure Indication Not Setup See Manual	The trailer tire pressure monitoring system is not setup.

# Integrated Trailer Brake Controller (If Equipped)

## WHAT IS THE INTEGRATED TRAILER BRAKE CONTROLLER

The trailer brake controller assists in smooth and effective trailer braking based on the towing vehicle's brake pressure.

## INTEGRATED TRAILER BRAKE CONTROLLER PRECAUTIONS



**WARNING:** Use the integrated trailer brake controller to properly adjust the trailer brakes and check all connections before towing a trailer. Failure to follow this instruction could result in the loss of control of your vehicle, personal injury or death.

- Only use the manual control lever for proper adjustment of the gain during trailer setup. Misuse, such as application during trailer sway, could cause instability of the trailer or tow vehicle.
- Avoid towing in adverse weather conditions. The trailer brake controller does not provide anti-lock control of the trailer wheels. Trailer wheels can lock up on slippery surfaces, resulting in reduced stability of the trailer and tow vehicle.
- The trailer brake controller is a factory-installed or dealer-installed item only. Ford is not responsible for warranty or performance of the trailer brake controller due to misuse or customer installation.

**Note:** Do not attempt to remove the trailer brake controller without consulting the *Workshop Manual*. Damage to the unit may result.

**Note:** Make sure to set the integrated trailer brake controller gain to 0 if you are using an aftermarket trailer brake controller.

## USING THE INTEGRATED TRAILER BRAKE CONTROLLER

1. Make sure the trailer brakes are in good working condition, functioning normally and properly adjusted. See your trailer dealer if necessary.

**Note:** An authorized dealer can diagnose the trailer brake controller to determine exactly which trailer fault has occurred. Your vehicle warranty does not cover issues with your trailer.

2. Hook up the trailer and make the electrical connections according to the trailer manufacturer's instructions.

**Note:** Select default mode if the trailer has surge brakes, or no brakes at all. The system has no effect on the braking performance of the trailer in either of these cases.

**Note:** If a trailer is connected by a four-pin connector, the trailer braking function will not be supported.

3. When you plug in a trailer with electric or electric-over-hydraulic brakes, a message confirming connection appears in the instrument cluster display.
4. Use the gain adjustment to find the desired starting point. A gain setting of 6.0 is a good starting point for heavier loads.

**Note:** Use the following steps to adjust the gain setting whenever road, weather and trailer, or vehicle loading conditions, change from when you initially set the gain.

5. In a traffic-free environment, tow the trailer on a dry, level surface and squeeze the manual control lever completely.

## Integrated Trailer Brake Controller (If Equipped)

- If the trailer wheels lock up, indicated by squealing tires, reduce the gain setting. If the trailer wheels turn freely, increase the gain setting. Repeat Steps 5 and 6 until the gain setting is at a point just below trailer wheel lock-up. If towing a heavier trailer, trailer wheel lock-up may not be attainable even with the maximum gain setting of 10.

**Note:** Only perform this procedure at speeds of approximately 20–25 mph (30–40 km/h).

**Note:** The trailer brake controller reduces output at vehicle speeds below 11 mph (18 km/h) so that trailer and vehicle braking is not jerky or harsh. This feature is only available when applying the brakes using your vehicle's brake pedal, not the controller.

**Note:** Your vehicle's brake system and the trailer brake system work independently of each other. Changing the gain setting on the controller does not affect the operation of your vehicle's brakes whether you attach a trailer or not.

**Note:** With the proper electrical connection, pressing your vehicle brake pedal or using the manual control lever illuminates both trailer and vehicle brake lamps.

**Note:** When you switch the vehicle off, the controller output is disabled and the display and module shut down. The controller module and display turn on when you switch the vehicle on.

**Note:** Trailer braking is suspended during stop/start events to minimize battery draw.

### Adjusting the Trailer Brake Gain

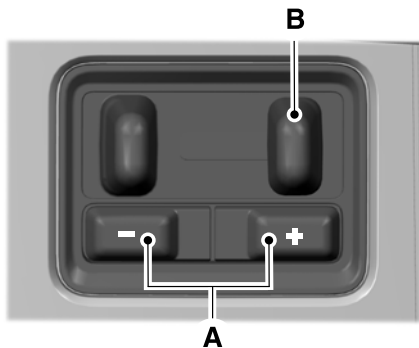

- Use the gain adjustment (+) and (-) buttons to increase or decrease the gain setting to the desired starting point. The trailer brake controller allows adjustment of brake gain from 0% to 100% in 5% increments.
- Trailer braking is directly applied by the driver through this manual slider.

**Note:** Adjust gain setting before using the trailer brake controller for the first time.

**Note:** The gain should be set to provide the maximum trailer braking assistance while making sure the trailer wheels do not lock when using the brakes. Locked trailer wheels may lead to trailer instability.

**Note:** Setting adjustments are saved when a trailer profile is selected.

# Integrated Trailer Brake Controller (If Equipped)

## ADJUSTING THE INTEGRATED TRAILER BRAKE CONTROLLER MODE

Select the correct integrated trailer brake controller mode option using the touchscreen.

**Note:** Trailer brake gain settings are saved to the active trailer profile.

### Selecting the Trailer Brake Type

1. Press **Default** for trailers with electromagnetic drum brake systems or press **Electric over Hydraulic** for trailers with electrically actuated hydraulic brake systems.

2. Press **Save**.

### Selecting the Trailer Brake Effort

1. Select a setting for your trailer.

**Note:** The default value is **Low** and is the recommended setting for most trailers. Select a different setting if your trailer's brakes require more initial voltage, or you prefer more aggressive trailer braking.

2. Press **Save**.

## INTEGRATED TRAILER BRAKE CONTROLLER – TROUBLESHOOTING

### INTEGRATED TRAILER BRAKE CONTROLLER – INFORMATION MESSAGES

Message	Details
Trailer Disconnected	The system detects the trailer wiring connection is disconnected, during a given ignition cycle.
Trailer Wiring Fault	The system detects an electrical fault in the trailer brake circuit. If this message appears without a trailer attached, see your authorized dealer. If a trailer is attached, inspect and repair the trailer wiring.
Trailer Brake Gain: {trailer gain value:#0.0}	Displays the current gain setting for the trailer brake.
Trailer Brake Gain: {trailer gain value:#0.0} No Trailer	Displays the current gain setting for the trailer brake when you do not have a trailer connected.

# Integrated Trailer Brake Controller (If Equipped)

---

## **INTEGRATED TRAILER BRAKE CONTROLLER – FREQUENTLY ASKED QUESTIONS**

### **How do I determine if there is an issue with the wiring on my vehicle?**

A message displays accompanied by a single tone, when no trailer is connected. This indicates that the issue is between the trailer brake controller and the 7-pin connector at the bumper.

### **How do I determine if there is an issue with the wiring on my trailer?**

A message only displays with a trailer connected. Consult your trailer dealer for assistance.

# Trailer Sway Control

## HOW DOES TRAILER SWAY CONTROL WORK

The system applies the brakes to the individual wheels and reduces torque to aid vehicle stability.

If the trailer begins to sway, the stability control lamp flashes and the message **Trailer Sway Reduce Speed** appears in the information display.

Stop your vehicle as soon as it is safe to do so. Check the vertical weight on the tow ball and trailer load distribution.

## TRAILER SWAY CONTROL PRECAUTIONS



**WARNING:** Turning off trailer sway control increases the risk of loss of vehicle control, serious injury or death. Ford does not recommend disabling this feature except in situations where speed reduction may be detrimental (such as hill climbing), the driver has significant trailer towing experience, and can control trailer sway and maintain safe operation.

**Note:** *This feature only activates when significant trailer sway occurs.*

**Note:** *This feature does not prevent trailer sway, but reduces it once it begins.*

**Note:** *This feature cannot stop all trailers from swaying.*

**Note:** *In some cases, if vehicle speed is too high, the system may activate multiple times, gradually reducing vehicle speed.*

## SWITCHING TRAILER SWAY CONTROL ON AND OFF - VEHICLES WITH: 12.3 INCH SCREEN

1. Press **Features** on the touchscreen.
2. Press **Towing**.
3. Switch **Trailer Sway Control** on or off.

The system turns on each time you start your vehicle.

## SWITCHING TRAILER SWAY CONTROL ON AND OFF - VEHICLES WITH: 15 INCH SCREEN

1. Access the vehicle drawer on the touchscreen.
2. Press **SETTINGS**.
3. Press **Towing**.
4. Switch **Trailer Sway Control** on or off.

The system turns on each time you start your vehicle.

# Trailer Reversing Aid - Vehicles With: Pro Trailer Backup Assist

## WHAT IS THE TRAILER REVERSING AID

The Pro Trailer Backup Assist utilizes the control knob on the instrument panel to help you steer a trailer. Turn the control knob in the direction you want the trailer to go and the system steers the vehicle.

## HOW DOES THE TRAILER REVERSING AID WORK

The trailer reversing aid uses a sensor attached to the trailer to detect the trailer angle relative to the towing vehicle and provides instructions, graphics and camera views on the touchscreen.

## TRAILER REVERSING AID PRECAUTIONS



**WARNING:** Driving while distracted can result in loss of vehicle control, crash and injury. We strongly recommend that you use extreme caution when using any device that may take your focus off the road. Your primary responsibility is the safe operation of your vehicle. We recommend against the use of any hand-held device while driving and encourage the use of voice-operated systems when possible. Make sure you are aware of all applicable local laws that may affect the use of electronic devices while driving.



**WARNING:** This system is an extra driving aid. It does not replace your attention and judgment, or the need to apply the brakes. This system does NOT automatically brake your vehicle. If you fail to press the brake pedal when necessary, you may collide with another vehicle.

**Note:** *The system is not a substitute for safe driving practices. Always be aware of your vehicle and trailer combination, and the surrounding environment.*

**Note:** *The system does not detect or prevent your vehicle or trailer from making contact with obstacles in the surrounding environment.*

**Note:** *The front end of your vehicle swings out when changing the direction of the trailer.*

**Note:** *In certain conditions, the trailer could turn faster or the trailer angle could increase more than anticipated. Always monitor the clearance between the trailer and vehicle and the surroundings.*

## SETTING UP THE TRAILER REVERSING AID FOR A CONVENTIONAL TRAILER

### CONFIGURING THE TRAILER

You must configure a trailer in the system to use the trailer reversing aids. This is a one-time setup process and the trailer information is saved in the system for the next time you use that trailer.

The system only works with conventional trailers. It does not work with other types including goose neck and fifth wheel. The following illustration shows examples of conventional trailers on the left-hand side.

# Trailer Reversing Aid - Vehicles With: Pro Trailer Backup Assist

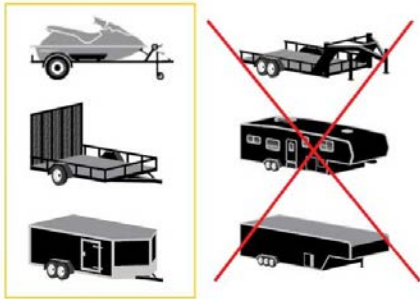

## Positioning the Trailer

Hitch your trailer to the truck and connect the electrical wiring harness. Check to make sure that the wiring is working. See **Connecting a Trailer** (page 348).



Park your vehicle and hitched trailer on a level surface.

For best results, make sure that your trailer rides level with the ground when you hitch your vehicle. See **Connecting a Trailer** (page 348).



Make sure that the trailer and your vehicle are in line with each other. You can do this by putting the transmission in drive (D) and pulling straight forward.

## Configuring the Trailer in the Touchscreen



1. Press the button to switch the system on.
2. Press **Add Trailer** on the touchscreen.
3. Follow the directions on the touchscreen to enter the trailer name and trailer type, then proceed to the sensor setup.



# Trailer Reversing Aid - Vehicles With: Pro Trailer Backup Assist

## TRAILER SENSOR INSTALLATION



Refer to the instructions included with your trailer sensor for detailed information regarding installation.

**Note:** Make sure the arrows on the sensor housing are facing up. Mount the sensor to a vertical part of the trailer that pivots when you turn your vehicle. Do not mount to a stationary surface such as the truck side of the trailer hitch.

## CALIBRATING THE SYSTEM

Calibrating the system requires driving forward and turning left or right. Follow the instructions on the touchscreen to complete the calibration process.

**Note:** To calibrate the system, you need an area where you can safely drive forward and turn left or right. An open parking lot is an ideal place to perform the calibration.

**Note:** Keep the steering wheel straight when instructed to by the touchscreen. If the steering wheel is in a turned position during this instruction, the calibration pauses.

**Note:** During calibration, the system determines the trailer length. The system supports trailer lengths of 6–33 ft (1.85–10.05 m) distance from the hitch point to the center of the axle or axles. The system is designed to work with drawbars that have a license plate to hitch ball center measurement of 9–18 in (23–46 cm) when installed. Do not attempt to use drawbars or trailers that have a length outside of this range as the system performance degrades and could cause improper system function.

**Note:** The touchscreen shows if you are going too slow or fast. Calibration pauses if the speed is outside the required range of 2–16 mph (4–25 km/h).

**Note:** You need to turn approximately 90° to calibrate the system. Some trailers could require you to drive straight then turn multiple times before calibration is complete. The touchscreen provides instructions and notifies you when calibration is complete.

# Trailer Reversing Aid - Vehicles With: Pro Trailer Backup Assist

## SWITCHING THE TRAILER REVERSING AID ON AND OFF

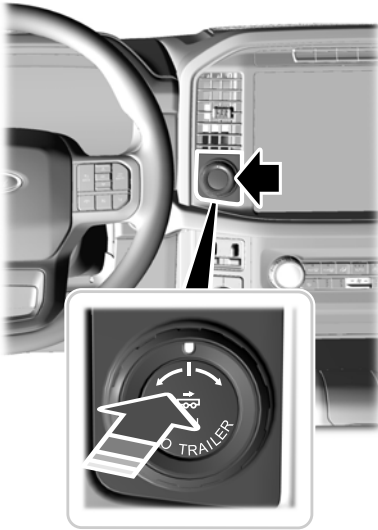

Press the button and use the touchscreen to select the connected trailer.

**Note:** A trailer must be configured to use Pro Trailer Backup Assist. See **Configuring the Trailer** (page 363).

**Note:** If you use the steering wheel when using Pro Trailer Backup Assist, the system turns off and a message displays in the touchscreen.

**Note:** If the trailer was connected just prior to turning the system on, you may need to drive forward to initialize the system. Follow the instructions on the touchscreen to activate the system.

## USING THE TRAILER REVERSING AID CONTROLLER

Use the control knob to steer the trailer. Take your hands off the steering wheel and turn the control knob instead. The control knob acts as the steering control for the trailer.



Turn and hold counterclockwise to make the trailer go left.



Turn and hold clockwise to make the trailer go right.

# Trailer Reversing Aid - Vehicles With: Pro Trailer Backup Assist

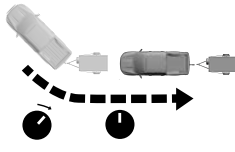

Release the knob when the trailer is moving in the direction you want.

**Note:** *The more you turn the knob, the sharper the trailer turns.*

**Note:** *Quickly turning and releasing the knob results in a jerky movement of the vehicle.*

**Note:** *You may have to use the knob to correct the trailer direction when attempting to move the trailer straight back under some conditions.*

## USING THE TRAILER REVERSE GUIDANCE VIEWS

Up to seven camera views could be available when using the trailer reversing aid. Use the view that helps you the most when reversing your vehicle and trailer.



360° camera view. Shows a 360° view on the right-hand side of the touchscreen with a rear camera view on the left-hand side of the touchscreen.



Rear view camera view. Shows your trailer hitch or what is directly behind your vehicle.



Rear split view camera view. Shows a 180° degree view of what is behind your vehicle.



Bed camera view. Shows the truck bed.



Trailer AUX camera view. Shows a rear view camera image of what is behind your trailer. This camera is available separately.



Trailer reverse guidance view. Shows you a view of the sides of your truck and the trailer. In auto mode, this view moves as the trailer moves so that you do not have to adjust the camera as you turn. Left and right arrows let you see other camera views.



Auto. Press to return to auto view.

**Note:** *Auto mode is the default setting.*

## Hitch Angle Graphic

The hitch angle graphic shows a small representation of your truck and trailer with visual feedback to help you monitor the trailer. The graphic shows two different colored lines for the trailer hitch angle. A black line shows you where your trailer is in relation to your vehicle. The white line represents the amount the trailer can turn based on knob input.

The graphic shows a yellow and red zone for the hitch angle to warn you of a high angle condition that could require you to pull forward to reduce the hitch angle. The angle limits for each zone vary based on the trailer length.

The yellow zone indicates you are approaching the maximum controllable trailer angle for the system. When the trailer enters this zone, it is more difficult to reduce the trailer turn when backing up. It may be necessary to put your vehicle back into drive (D) and pull forward to get the truck and trailer back in line.

# Trailer Reversing Aid - Vehicles With: Pro Trailer Backup Assist

---

The red zone indicates you have exceeded the maximum controllable trailer angle for the system. Immediately stop reversing. Put your vehicle into drive (D) and pull forward until the trailer is no longer in the red zone.

## Setting the Trailer Angle Limit

1. Press **Features** on the touchscreen.
2. Press **Towing**.
3. Press **Manage trailers**.
4. Press **Pro Trailer Backup Assist**.
5. Press **Trailer Angle Limit**.

6. Press a setting.

### **Normal Control Angle**

Default setting. This provides a balanced limit that returns from a turn to straight backing with minimal change to the trailer direction.

### **Max Control Angle**

Increases the trailer angle limit close to the maximum controllable angle to allow sharper turns but also causes more change in the trailer direction when straightening out from a turn.

# Trailer Reversing Aid - Vehicles With: Pro Trailer Backup Assist

## TRAILER REVERSING AID - TROUBLESHOOTING

### TRAILER REVERSING AID – INFORMATION MESSAGES

Message	Description
Detecting Trailer Please Wait...	Displays when the system turns on and is initializing.
Pro Trailer Backup Assist™ System is Not Available	A condition exists that prevents the system from turning on. If the message continues to display, visit your authorized dealer to have your vehicle checked.
Trailer Reverse Guidance System is Not Available	
Pro Trailer Backup Assist™ Driving Required to Initialize Steering Press Knob to Exit	The steering system needs to learn internal parameters to fully enable the feature. Drive your vehicle straight forward above 25 mph (40 km/h) for approximately 5 minutes.
Trailer Reverse Guidance Driving Required to Initialize Steering Press OK to Exit	
Pro Trailer Backup Assist™ Stop now Maximum trailer angle Press Knob to Exit	Displays when you reach the maximum controllable trailer angle for the system. Place your vehicle in drive (D) and pull forward to get the truck and trailer back to an in-line position. If this message consistently displays, you may need to repeat the trailer calibration. Delete the trailer from the system and repeat the setup and calibration process.
Stop now. Deactivated by trailer angle.	Displays when you exceed the maximum controllable trailer angle for the system. Place your vehicle in drive (D) and pull forward to get your vehicle and trailer back to an in-line position, then activate the system by selecting the connected trailer and following the instructions on the touchscreen. If this message consistently displays, you may need to repeat the trailer setup and calibration. Delete the trailer from the system and repeat the setup and calibration process.
Pro Trailer Backup Assist™ Stop Now Take Control of Steering Wheel	Displays when the system can no longer steer the vehicle and you must take over steering.

## Trailer Reversing Aid - Vehicles With: Pro Trailer Backup Assist

Message	Description
Pro Trailer Backup Assist™ Sensor Not Detected Refer to Owner's Manual Press Knob to Exit	Displays when the system does not detect the sensor. Check the sensor connection, that there is no damaged wiring between the connector and sensor and that there is only one sensor connected.
Trailer Reverse Guidance Sensor Not Detected Refer to Owner's Manual Press OK to Exit	
Pro Trailer Backup Assist™ Trailer Not Detected. Shift to Park Press Knob to Exit	These messages display when the system does not detect the trailer. Check that the sensor is correctly installed and the trailer length is within the allowed range. If these messages continue to display, visit your authorized dealer to have your vehicle checked.
Pro Trailer Backup Assist™ Trailer Not Detected. Refer to Owner's Manual. Press Knob to Exit	
Trailer Reverse Guidance Trailer Not Detected. Refer to Owner's Manual. Press OK to Exit	
Pro Trailer Backup Assist™ Trailer Not Detected Pull Forward to Initialize Press Knob to Exit	These messages display when your vehicle has not moved after the trailer sensor is connected or extended operation below 1 mph (1 km/h). Drive forward above 2 mph (3 km/h) to initialize the system.
Trailer Reverse Guidance Trailer Not Detected Pull Forward to Initialize Press OK to Exit	
Pro Trailer Backup Assist™ Stop Now System Not Active Press Knob to Exit	Displays when your vehicle is backing up but the system is not activated. Select the connected trailer on the touchscreen and follow the instructions to activate the system. This message also displays when you back up during the calibration process.
Pro Trailer Backup Assist™ Backup Slowly Turn Knob to Steer Press Knob to Exit	Displays when the system turns on and is available to use.

# Trailer Reversing Aid - Vehicles With: Trailer Reverse Guidance (TRG)

## WHAT IS THE TRAILER REVERSING AID

Trailer Reverse Guidance provides views and graphics on the touchscreen to help you steer your vehicle when you backup a trailer.

## HOW DOES THE TRAILER REVERSING AID WORK

The trailer reversing aid uses a sensor attached to the trailer to detect the trailer angle relative to the towing vehicle and provides instructions, graphics and camera views on the touchscreen.

## TRAILER REVERSING AID PRECAUTIONS



**WARNING:** Driving while distracted can result in loss of vehicle control, crash and injury. We strongly recommend that you use extreme caution when using any device that may take your focus off the road. Your primary responsibility is the safe operation of your vehicle. We recommend against the use of any hand-held device while driving and encourage the use of voice-operated systems when possible. Make sure you are aware of all applicable local laws that may affect the use of electronic devices while driving.



**WARNING:** This system is an extra driving aid. It does not replace your attention and judgment, or the need to apply the brakes. This system does NOT automatically brake your vehicle. If you fail to press the brake pedal when necessary, you may collide with another vehicle.

**Note:** The system is not a substitute for safe driving practices. Always be aware of your vehicle and trailer combination, and the surrounding environment.

**Note:** The system does not detect or prevent your vehicle or trailer from making contact with obstacles in the surrounding environment.

**Note:** The front end of your vehicle swings out when changing the direction of the trailer.

**Note:** In certain conditions, the trailer could turn faster or the trailer angle could increase more than anticipated. Always monitor the clearance between the trailer and vehicle and the surroundings.

## SETTING UP THE TRAILER REVERSING AID FOR A CONVENTIONAL TRAILER

### CONFIGURING THE TRAILER

You must configure a trailer in the system to use the trailer reversing aids. This is a one-time setup process and the trailer information is saved in the system for the next time you use that trailer.

The system only works with conventional trailers. It does not work with other types including goose neck and fifth wheel. The following illustration shows examples of conventional trailers on the left-hand side.

**Note:** Trailer reverse guidance camera views are available with no trailer set up. However, complete functionality including graphics and automatic view switching is enabled by setup. Setup is required to enable the Trailer backup assist feature.

# Trailer Reversing Aid - Vehicles With: Trailer Reverse Guidance (TRG)

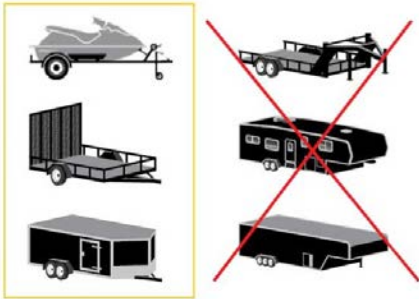

## Positioning the Trailer

Hitch your trailer to the truck and connect the electrical wiring harness. Check to make sure that the wiring is working. See **Connecting a Trailer** (page 348).



Park your vehicle and hitched trailer on a level surface.

For best results, make sure that your trailer rides level with the ground when you hitch your vehicle. See **Connecting a Trailer** (page 348).



Make sure that the trailer and your vehicle are in line with each other. You can do this by putting the transmission in drive (D) and pulling straight forward.

## Configuring the Trailer in the Touchscreen

1. Shift to reverse (R).
2. Press the camera view button.
3. Press the trailer view icon.
4. Press **Add Trailer**.
5. Follow the directions on the touchscreen to enter the trailer name and trailer type, then proceed to the sensor setup.

## TRAILER SENSOR INSTALLATION

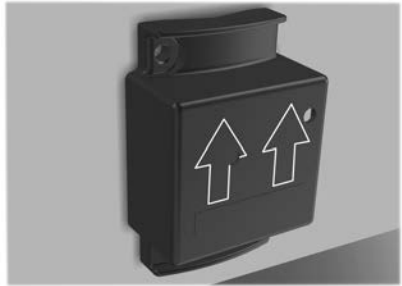

Refer to the instructions included with your trailer sensor for detailed information regarding installation.



# Trailer Reversing Aid - Vehicles With: Trailer Reverse Guidance (TRG)

**Note:** Make sure the arrows on the sensor housing are facing up. Mount the sensor to a vertical part of the trailer that pivots when you turn your vehicle. Do not mount to a stationary surface such as the truck side of the trailer hitch.

## CALIBRATING THE SYSTEM

Calibrating the system requires driving forward and turning left or right. Follow the instructions on the touchscreen to complete the calibration process.

**Note:** To calibrate the system, you need an area where you can safely drive forward and turn left or right. An open parking lot is an ideal place to perform the calibration.

**Note:** Keep the steering wheel straight when instructed to by the touchscreen. If the steering wheel is in a turned position during this instruction, the calibration pauses.

**Note:** During calibration, the system determines the trailer length. The system supports trailer lengths of 6–33 ft (1.85–10.05 m) distance from the hitch point to the center of the axle or axles. The system is designed to work with drawbars that have a license plate to hitch ball center measurement of 9–18 in (23–46 cm) when installed. Do not attempt to use drawbars or trailers that have a length outside of this range as the system performance degrades and could cause improper system function.

**Note:** The touchscreen shows if you are going too slow or fast. Calibration pauses if the speed is outside the required range of 2–16 mph (4–25 km/h).

**Note:** You need to turn approximately 90° to calibrate the system. Some trailers could require you to drive straight then turn multiple times before calibration is complete. The touchscreen provides instructions and notifies you when calibration is complete.

## SWITCHING THE TRAILER REVERSING AID ON AND OFF

Shift into reverse (R), press the rear camera button to expand the menu, press the trailer icon and use the touchscreen to select the connected trailer.

**Note:** If the trailer was connected just prior to turning the system on, you may need to drive forward to initialize the system. Follow the instructions on the touchscreen to activate the system.

## USING THE TRAILER REVERSE GUIDANCE VIEWS

Up to seven camera views could be available when using the trailer reversing aid. Use the view that helps you the most when reversing your vehicle and trailer.



360° camera view. Shows a 360° view on the right-hand side of the touchscreen with a rear camera view on the left-hand side of the touchscreen.



Rear view camera view. Shows your trailer hitch or what is directly behind your vehicle.



Rear split view camera view. Shows a 180° degree view of what is behind your vehicle.



Bed camera view. Shows the truck bed.



Trailer AUX camera view. Shows a rear view camera image of what is behind your trailer. This camera is available separately.

# Trailer Reversing Aid - Vehicles With: Trailer Reverse Guidance (TRG)



Trailer reverse guidance view. Shows you a view of the sides of your truck and the trailer. In auto mode, this view moves as the trailer moves so that you do not have to adjust the camera as you turn. Left and right arrows let you see other camera views.



Straight backup mode. Shows which way to turn your steering wheel to keep the trailer straight.

Use this view when you want to keep your trailer in line with your truck.

**Note:** *It may be helpful to shift your vehicle into drive (D), pull forward and straighten out the vehicle and trailer before engaging straight backup mode.*



This takes you back to the 360° camera system and out of the trailer reverse guidance feature.



Auto. Press to return to auto view.

**Note:** *Auto mode is the default setting.*

## Hitch Angle Graphic

The hitch angle graphic shows a small representation of your truck and trailer with visual feedback to help you monitor the trailer. The graphic shows two different colored lines for the trailer hitch angle. A black line shows you where your trailer is in relation to your vehicle. The white line represents the amount the trailer can turn based on steering wheel position.

The graphic shows a yellow and red zone for the hitch angle to warn you of a high angle condition that could require you to pull forward to reduce the hitch angle. The angle limits for each zone vary based on the trailer length.

The yellow zone indicates you are approaching the maximum controllable trailer angle for the system. When the trailer enters this zone, it is more difficult to reduce the trailer turn when backing up. It may be necessary to put your vehicle back into drive (D) and pull forward to get the truck and trailer back in line.

The red zone indicates you have exceeded the maximum controllable trailer angle for the system. Immediately stop reversing. Put your vehicle into drive (D) and pull forward until the trailer is no longer in the red zone.

# Trailer Reversing Aid - Vehicles With: Trailer Reverse Guidance (TRG)

## TRAILER REVERSING AID - TROUBLESHOOTING

### TRAILER REVERSING AID – INFORMATION MESSAGES

Message	Description
Detecting Trailer Please Wait...	Displays when the system turns on and is initializing.
Pro Trailer Backup Assist™ System is Not Available	A condition exists that prevents the system from turning on. If the message continues to display, visit your authorized dealer to have your vehicle checked.
Trailer Reverse Guidance System is Not Available	
Pro Trailer Backup Assist™ Driving Required to Initialize Steering Press Knob to Exit	The steering system needs to learn internal parameters to fully enable the feature. Drive your vehicle straight forward above 25 mph (40 km/h) for approximately 5 minutes.
Trailer Reverse Guidance Driving Required to Initialize Steering Press OK to Exit	
Pro Trailer Backup Assist™ Stop now Maximum trailer angle Press Knob to Exit	Displays when you reach the maximum controllable trailer angle for the system. Place your vehicle in drive (D) and pull forward to get the truck and trailer back to an in-line position. If this message consistently displays, you may need to repeat the trailer calibration. Delete the trailer from the system and repeat the setup and calibration process.
Stop now. Deactivated by trailer angle.	Displays when you exceed the maximum controllable trailer angle for the system. Place your vehicle in drive (D) and pull forward to get your vehicle and trailer back to an in-line position, then activate the system by selecting the connected trailer and following the instructions on the touchscreen. If this message consistently displays, you may need to repeat the trailer setup and calibration. Delete the trailer from the system and repeat the setup and calibration process.
Pro Trailer Backup Assist™ Stop Now Take Control of Steering Wheel	Displays when the system can no longer steer the vehicle and you must take over steering.

## Trailer Reversing Aid - Vehicles With: Trailer Reverse Guidance (TRG)

Message	Description
Pro Trailer Backup Assist™ Sensor Not Detected Refer to Owner's Manual Press Knob to Exit	Displays when the system does not detect the sensor. Check the sensor connection, that there is no damaged wiring between the connector and sensor and that there is only one sensor connected.
Trailer Reverse Guidance Sensor Not Detected Refer to Owner's Manual Press OK to Exit	
Pro Trailer Backup Assist™ Trailer Not Detected. Shift to Park Press Knob to Exit	These messages display when the system does not detect the trailer. Check that the sensor is correctly installed and the trailer length is within the allowed range. If these messages continue to display, visit your authorized dealer to have your vehicle checked.
Pro Trailer Backup Assist™ Trailer Not Detected. Refer to Owner's Manual. Press Knob to Exit	
Trailer Reverse Guidance Trailer Not Detected. Refer to Owner's Manual. Press OK to Exit	
Pro Trailer Backup Assist™ Trailer Not Detected Pull Forward to Initialize Press Knob to Exit	These messages display when your vehicle has not moved after the trailer sensor is connected or extended operation below 1 mph (1 km/h). Drive forward above 2 mph (3 km/h) to initialize the system.
Trailer Reverse Guidance Trailer Not Detected Pull Forward to Initialize Press OK to Exit	
Pro Trailer Backup Assist™ Stop Now System Not Active Press Knob to Exit	Displays when your vehicle is backing up but the system is not activated. Select the connected trailer on the touchscreen and follow the instructions to activate the system. This message also displays when you back up during the calibration process.
Pro Trailer Backup Assist™ Backup Slowly Turn Knob to Steer Press Knob to Exit	Displays when the system turns on and is available to use.

# Trailer Hitching Assistance

## WHAT IS TRAILER HITCHING ASSISTANCE

Trailer hitching assistance helps the driver align the vehicle hitch ball to a trailer coupler.

## HOW DOES TRAILER HITCHING ASSISTANCE WORK

Trailer hitching assistance uses the following to detect your trailer:

- Rear view camera.
- Radar.
- Parking aid sensors.
- External rear lighting.

This feature also controls the following to align the hitch ball with the trailer coupler:

- Steering.
- Shifting.
- Braking and acceleration.

**Note:** Blocked sensors could affect system performance. Do not cover the sensors with bumper stickers, tape, repair compound or other objects.

## TRAILER HITCHING ASSISTANCE PRECAUTIONS



**WARNING:** You are responsible for controlling your vehicle at all times. The system is designed to be an aid and does not relieve you of your responsibility to drive with due care and attention. Failure to follow this instruction could result in the loss of control of your vehicle, personal injury or death.



**WARNING:** The system is not designed to detect cyclists, motorcyclists, pedestrians or animals. Apply the brakes when necessary. Failure to follow this instruction could result in personal injury or death.



**WARNING:** The system may not operate properly during severe weather conditions, for example snow, ice, heavy rain and spray. Always drive with due care and attention. Failure to take care may result in a crash.

**Note:** Trailer hitching assistance only works with conventional trailers, couplers and hitch balls.

**Note:** The hitch ball must be properly installed on the vehicle for the system to function as intended. An improperly installed hitch ball could result in damage to your vehicle or trailer.

**Note:** Certain aftermarket modifications such as oversized tires or lift kits could make trailer hitching assistance fail or not work as intended.

**Note:** Keep the sensors and camera free from snow, ice and dirt.

**Note:** Clean the camera lens with a soft, lint-free cloth and non-abrasive cleaner.

## TRAILER HITCHING ASSISTANCE LIMITATIONS

The system could not function or could function with reduced performance during the following:

- When using trailer hitching assistance in tall grass and weeds.
- When safety chains, cables or wiring are dangling near the coupler.
- When using trailer hitching assistance on slippery surfaces.

# Trailer Hitching Assistance

- When using hitches that raise the hitch ball more than 4 in (10 cm), lower the hitch ball by more than 6 in (16 cm) or extend the hitch ball away from the vehicle more than 12 in (30 cm).
- When using objects taller than 8 in (20 cm), such as large blocks, under the jack stand.
- When you park the trailer on surfaces that are similar in color to the trailer coupler and hitch ball.
  - A black coupler or hitch ball over a dark asphalt surface.
  - A light color coupler or hitch ball over a light concrete surface.
- When there are low or no light sources, such as at night.

Press the button to switch the system on and off. You can also switch the system on and off through the touchscreen.

## USING TRAILER HITCHING ASSISTANCE

Before switching on the system, make sure that your vehicle is:

- In front of the trailer facing the same direction.
- Within 20 ft (6 m) of the trailer and no closer than 7 ft (2 m).
- Less than a 15° approach angle to the trailer.
- Within 3 ft (1 m) of straight in-line with the trailer.
- Clear of obstacles or other vehicles within 6 ft (1.8 m) to the side of your vehicle or the trailer.

## SWITCHING TRAILER HITCHING ASSISTANCE ON AND OFF

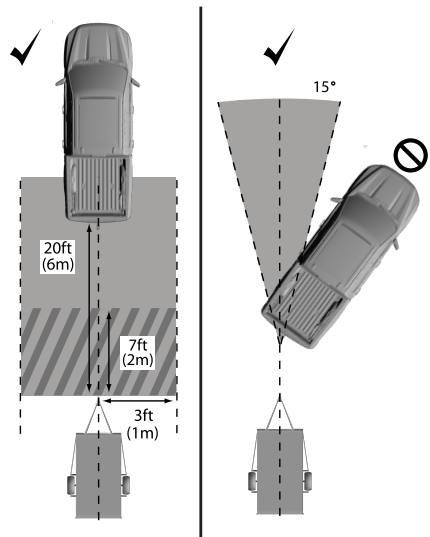
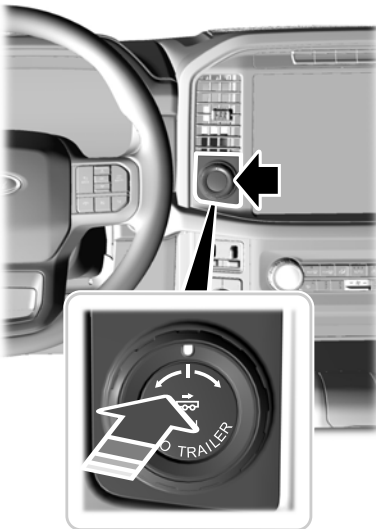

1. Press the button.

# Trailer Hitching Assistance

**Note:** Press the button to switch the system on and off.

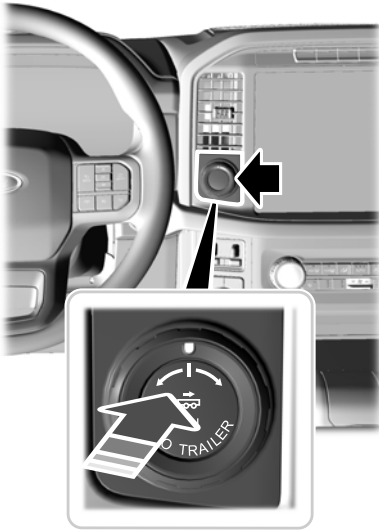

2. Follow the instructions on the touchscreen.

## TRAILER HITCHING ASSISTANCE INDICATORS



The white indicator represents the system searching for the trailer. Continue moving the vehicle until the trailer coupler is inside this indicator. The indicator turns green once the trailer coupler is in the correct position.



The bracket shows you the estimated location of your trailer.



The yellow indicator represents that you have positioned your vehicle too close to the trailer and you need to pull away from the trailer until the indicator turns green.

# Smart Hitch

## WHAT IS SMART HITCH

Smart hitch indicates if the trailer's load is within the recommended range based of the weight on the trailer and its cargo.

## HOW DOES SMART HITCH WORK

Smart hitch uses sensors mounted to the suspension to calculate the connected trailer's tongue load.

## SMART HITCH LIMITATIONS

You cannot use the system if any of the following occur:

- The wheels are not pointed straight ahead.
- Your vehicle is not in park (P).
- Your vehicle is not on a level surface.
- The tire pressures are below the recommended levels.
- Your vehicle is off.

## USING SMART HITCH - VEHICLES WITH: 12.3 INCH SCREEN

1. Press **Features** on the touchscreen.
2. Press Smart Hitch.

**Note:** You can also access smart hitch using the FordPass app.

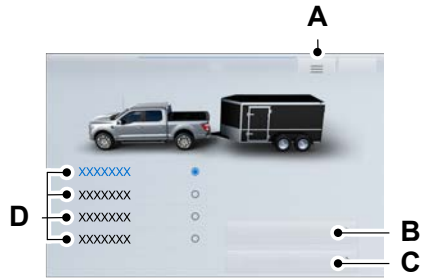

- A. Settings Menu.
- B. Quick setup.
- C. Connection Checklist.
- D. Hitch type selection.

## Hitch Type Selection

Press to change the hitch type.

## Quick Setup

Press to skip the trailer setup guide and adjust the load in the trailer to a balanced range.

## Connection Checklist

Press to go through the trailer setup guide and adjust the load in the trailer to a balanced range.

## Reset Hitch Weight

Press reset hitch weight to reset the weight on the hitch to zero.

## Loaded Trailer Weight

Press loaded trailer weight to set the total weight of the loaded trailer.



# Smart Hitch

**Note:** The vehicle's tongue weight is not available until you attach a trailer.

**Note:** Make sure you include both the trailer weight and the trailer cargo in your calculation for total weight of the loaded trailer.

## Smart Hitch Settings

Press the menu button when on the smart hitch screen.

## Measurement Units

Press to change measurement units between pounds and kilograms.

## USING SMART HITCH - VEHICLES WITH: 15 INCH SCREEN

1. Press Vehicle Drawer on the touchscreen.
2. Press Controls on the touchscreen.
3. Press Smart Hitch.

**Note:** You can also access smart hitch using the FordPass app.

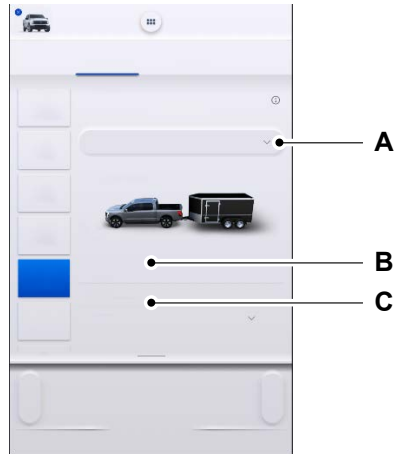

- A. Hitch type selection.
- B. Quick setup.
- C. Connection checklist.

## Hitch Type Selection

Press to change the hitch type.

## Quick Setup

Press to skip the trailer setup guide and adjust the load in the trailer to a balanced range.

## Connection Checklist

Press to go through the trailer setup guide and adjust the load in the trailer to a balanced range.

## Reset Hitch Weight

Press reset hitch weight to reset the weight on the hitch to zero.

# Smart Hitch

---

## Loaded Trailer Weight

Press loaded trailer weight to set the total weight on the loaded trailer.

**Note:** *The vehicle's tongue weight is not available until you attach a trailer.*

**Note:** *Make sure you include both the trailer weight and the trailer cargo in your calculation for total weight of the loaded trailer.*

## Measurement Units

Press to change measurement units between pounds and kilograms.

# On-Board Scale (If Equipped)

## WHAT IS ON-BOARD SCALE

On-board scale provides the estimated payload of your vehicle and warns when your vehicle is overloaded.

## HOW DOES ON-BOARD SCALE WORK

On-board scale uses sensors mounted to the suspension to calculate the vehicle's payload.

## ON-BOARD SCALE LIMITATIONS

You cannot use the system if any of the following occur:

- The wheels are not pointed straight ahead.
- Your vehicle is not in park (P).
- Your vehicle is not on a level surface.
- The tire pressures are below the recommended levels.
- Your vehicle is off.

## USING ON-BOARD SCALE - VEHICLES WITH: 12.3 INCH SCREEN

1. Press **Features** on the touchscreen.
2. Press **Onboard Scales**.

**Note:** You can also access on-board scale using the FordPass app.

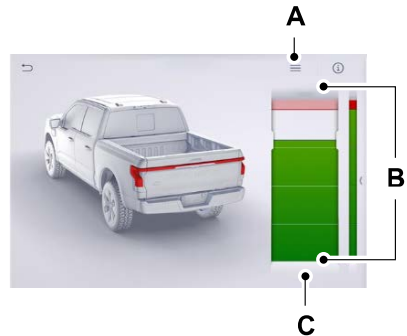

- A. Settings menu.
- B. Estimated payload.
- C. Payload Limit alert on and off.

## Payload Limit Alert

Press to switch so you can hear the audible alert when reaching the maximum payload.

## On-Board Scale Settings

Press the menu button when on the onboard scales screen.

## Vehicle Mode

Press to return to the onboard scales screen.

## Scale Mode

Press to see the weight added to the vehicle's current payload and to reset the scale to zero.

**Note:** The scale settings do not remain between key cycles.

## Passenger and Cargo Load Reminder

Press to switch the load reminder on or off.

## On-Board Scale (If Equipped)

### Set Passenger and Cargo Load Reminder

Press to set the estimated passengers and cargo load that are not in the vehicle when you use the on-board scale.

The default and minimum value is 200 lb (100 kg).

The maximum value is 1,400 lb (650 kg).

Press use current measurement to store the current number of occupants and payload of the vehicle.

### Measurement Units

Press to change measurement units between pounds and kilograms.

### USING ON-BOARD SCALE - VEHICLES WITH: 15 INCH SCREEN

1. Access the vehicle drawer on the touchscreen.
2. Press **CONTROLS**.
3. Press **Onboard Scales**.

**Note:** You can also access on-board scale using the FordPass app.

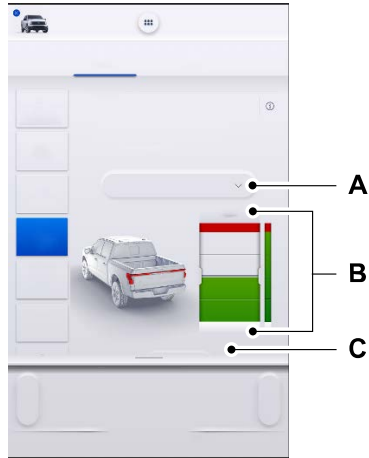

- A. Select between Vehicle/Scale Mode.
- B. Estimated payload.
- C. Payload limit alert on and off.

On-board scale indicates the current estimated payload, including passengers, and warns when you have exceeded the payload limit.

### Mode: Vehicle Mode

Press to see the current estimated payload including passengers.

### Mode: Scale Mode

Press to see the weight added to the vehicle's current payload and to reset the scale to zero.

**Note:** The scale settings remain between key cycles.

### Payload Limit Alert

Press to switch so you can hear the audible alert when reaching the maximum payload.

## On-Board Scale (If Equipped)

---

### **Passenger and Cargo Load Reminder**

Press to switch the load reminder on or off.

### **Set Passenger and Cargo Load Reminder**

Press to set the estimated passenger and cargo load that are not in the vehicle when you use the on-board scale.

The default and minimum value is 200 lb (100 kg).

The maximum value is 1,400 lb (650 kg).

Press use current measurement to store the current number of occupants and payload of the vehicle.

### **Measurement Units**

Press to change measurement units between pounds and kilograms.

# Trailer Backup Assistance

## WHAT IS TRAILER BACKUP ASSISTANCE

Trailer backup assistance utilizes the control knob on the instrument panel to help you steer a trailer. Turn the control knob in the direction you want the trailer to go and the system steers the vehicle.

## HOW DOES TRAILER BACKUP ASSISTANCE WORK

Trailer backup assistance uses a sticker or sensor attached to the trailer to detect the trailer angle relative to the towing vehicle and provides instructions, graphics and camera views on the touchscreen.

## TRAILER BACKUP ASSISTANCE PRECAUTIONS



**WARNING:** Driving while distracted can result in loss of vehicle control, crash and injury. We strongly recommend that you use extreme caution when using any device that may take your focus off the road. Your primary responsibility is the safe operation of your vehicle. We recommend against the use of any hand-held device while driving and encourage the use of voice-operated systems when possible. Make sure you are aware of all applicable local laws that may affect the use of electronic devices while driving.



**WARNING:** This system is an extra driving aid. It does not replace your attention and judgment, or the need to apply the brakes. This system does NOT automatically brake your vehicle. If you fail to press the brake pedal when necessary, you may collide with another vehicle.

**Note:** *The system is not a substitute for safe driving practices. Always be aware of your vehicle and trailer combination, and the surrounding environment.*

**Note:** *The system does not detect or prevent your vehicle or trailer from making contact with obstacles in the surrounding environment.*

**Note:** *The front end of your vehicle swings out when changing the direction of the trailer.*

**Note:** *In certain conditions, the trailer could turn faster or the trailer angle could increase more than anticipated. Always monitor the clearance between the trailer and vehicle and the surroundings.*

## SETTING UP THE TRAILER BACKUP ASSISTANCE FOR A CONVENTIONAL TRAILER

### CONFIGURING THE TRAILER

You must configure a trailer in the system to use trailer backup assistance. This is a one-time setup process and the system saves the trailer information for the next time you use that trailer.

The system only works with conventional trailers. It does not work with other types including fifth wheel and gooseneck. The following illustration shows examples of conventional trailers on the left-hand side.

# Trailer Backup Assistance

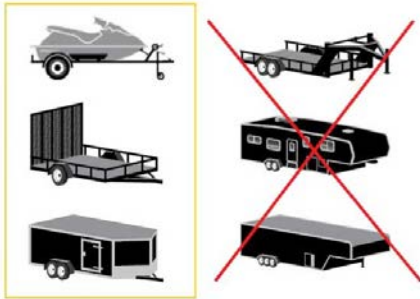

## Positioning the Trailer

Hitch the trailer to your vehicle and connect the electrical wiring harness. Check to make sure that the wiring is working. See **Connecting a Trailer** (page 348).



Park your vehicle and hitched trailer on a level surface.

For best results, make sure that your trailer rides level with the ground when you hitch your vehicle. See **Connecting a Trailer** (page 348).



Make sure that the trailer and your vehicle are in line with each other. You can do this by putting the transmission in drive (D) and pulling straight forward.

## Configuring the Trailer in the Touchscreen



1. Press the button to switch the system on.
2. Press **Add Trailer** on the touchscreen.
3. Follow the directions on the touchscreen to enter the trailer name and trailer type, then proceed to the sticker or sensor setup.

**Note:** Your vehicle has two options for trailer backup assistance setup. The system defaults to the camera based system. See **Applying the Trailer Reversing Aid Sticker** (page 388). You can also set up the system with the trailer sensor that you can purchase from your authorized dealer. You must connect the sensor to your vehicle to set up the system. See **Trailer Sensor Installation** (page 388).

# Trailer Backup Assistance

**Note:** If you configure the trailer and install a sensor, the system saves the trailer with that sensor information. If you want to use this trailer with the sticker, you need to delete the trailer from the system and repeat the setup process.

## APPLYING THE TRAILER REVERSING AID STICKER

Place the sticker in an area visible by the rear view camera. The entire sticker must be within 4–19 in (10–48 cm) from the center of the hitch ball, as shown in the following illustration.

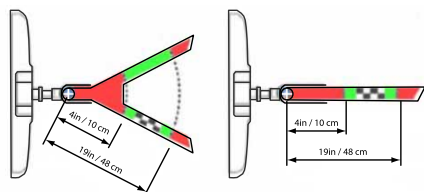

Use the supplied sticker placement card, a tape measure and pen to carefully mark the area to attach the sticker. The sticker is in the back cover pocket of your quick start guide. Make sure the entire sticker is within the green zone between the two arcs or distance markers on the diagram, and is also visible in the rear view camera display.

Once you have found the correct location, place the sticker.

**Note:** Make sure nothing can obstruct the rear view camera's view of the sticker such as a jack handle or wiring.

**Note:** Position the sticker on a flat, dry and clean horizontal surface. For best results, apply the sticker when temperatures are above 32°F (0°C).

**Note:** Do not move stickers after placing them. Do not re-use any stickers if removed.

**Note:** You can purchase additional stickers through your authorized dealer.

**Note:** If you previously setup the trailer with the trailer sensor, make sure it is not plugged in before configuring the trailer and placing the sticker.

## TRAILER SENSOR INSTALLATION





## Trailer Backup Assistance

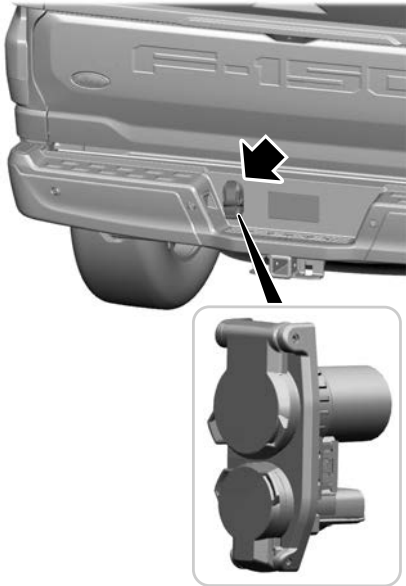

You need to purchase a sensor kit and 7/12 way connector to replace the 7/4 way connector on your vehicle to setup the system with a sensor. See your authorized dealer.

Refer to the instructions included with your trailer sensor for detailed information regarding installation.

**Note:** Make sure the arrows on the sensor housing are facing up. Mount the sensor to a vertical part of the trailer that pivots when you turn your vehicle. Do not mount to a stationary surface such as the truck side of the trailer hitch.

**Note:** To setup a trailer with a sensor, install the sensor on the trailer and plug the connector into the connector in your bumper prior to configuring the trailer. Trailers that were set up with a sensor still require the sensor to function. To change a trailer to use the sticker, delete the trailer in the system and repeat the trailer setup with the sticker.

### CALIBRATING THE SYSTEM

Calibrating the system requires driving forward and turning left or right. Follow the instructions on the touchscreen to complete the calibration process.

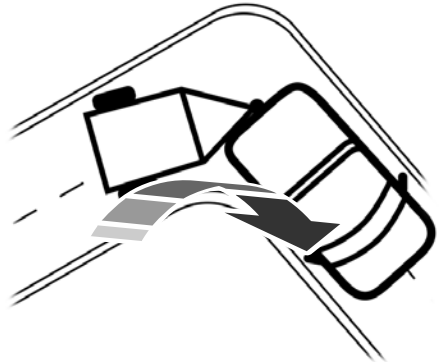

**Note:** To calibrate the system, you need an area where you can safely drive forward and turn left or right. An open parking lot is an ideal place to perform the calibration.

**Note:** Keep the steering wheel straight when instructed to by the touchscreen. If the steering wheel is in a turned position during this instruction, the calibration pauses.

## Trailer Backup Assistance

**Note:** During calibration, the system determines the trailer length. The system supports trailer lengths of 6–33 ft (1.85–10.05 m) distance from the hitch point to the center of the axle or axles. The system is designed to work with drawbars that have a license plate to hitch ball center measurement of 9–18 in (23–46 cm) when installed. Do not attempt to use drawbars or trailers that have a length outside of this range as the system performance degrades and could cause improper system function.

**Note:** The touchscreen shows if you are going too slow or fast. Calibration pauses if the speed is outside the required range of 2–9 mph (4–15 km/h).

**Note:** You need to complete at least a 90° turn, and longer trailers could require a 180° turn. Camera trailer tracking requires the system to locate the hitch ball as well as determine the trailer length. Some trailers could require you to drive straight then turn multiple times before calibration completes. The touchscreen provides instructions and notifies you when calibration completes.

**Note:** For best results, do not calibrate the system at night when calibrating the system with the sticker.

### SWITCHING TRAILER BACKUP ASSISTANCE ON AND OFF

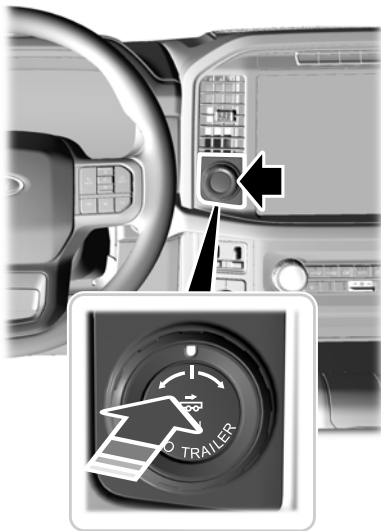

Press the button and use the touchscreen to select the connected trailer.

**Note:** A trailer must be configured to use trailer backup assistance. See **Configuring the Trailer** (page 363).

**Note:** If you use the steering wheel when using trailer backup assistance, the system turns off and a message displays in the touchscreen.

**Note:** If the trailer was connected just prior to turning the system on, you may need to drive forward to initialize the system. Follow the instructions on the touchscreen to activate the system.

# Trailer Backup Assistance

## USING THE TRAILER BACKUP ASSISTANCE CONTROLLER

Use the control knob to steer the trailer. Take your hands off the steering wheel and turn the control knob instead. The control knob acts as the steering control for the trailer.



Turn and hold counterclockwise to make the trailer go left.



Turn and hold clockwise to make the trailer go right.

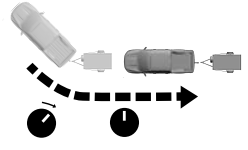

Release the knob when the trailer is moving in the direction you want.

**Note:** The more you turn the knob, the sharper the trailer turns.

**Note:** Quickly turning and releasing the knob results in a jerky movement of the vehicle.

**Note:** You may have to use the knob to correct the trailer direction when attempting to move the trailer straight back under some conditions.

## USING THE TRAILER BACKUP ASSISTANCE VIEWS

Up to seven camera views could be available when using trailer backup assistance. Use the view that helps you the most when reversing your vehicle and trailer.

**Note:** The rear view camera view is available on all vehicles with the trailer backup assist feature. Additional views are available on vehicle equipped with the trailer reverse guidance feature.



360° camera view. Shows a 360° view on the right-hand side of the touchscreen with a rear camera view on the left-hand side of the touchscreen.

# Trailer Backup Assistance



Rear view camera view. Shows your trailer hitch or what is directly behind your vehicle.



Rear split view camera view. Shows a 180° degree view of what is behind your vehicle.



Bed camera view. Shows the truck bed.

**Note:** This view also provides a picture-in-picture view.



Trailer AUX camera view. Shows a rear view camera image of what is behind your trailer. This camera is available separately.

**Note:** This view also provides a picture-in-picture view.



Trailer reverse guidance view. Shows you a view of the sides of your truck and the trailer. In auto mode, this view moves as the trailer moves so that you do not have to adjust the camera as you turn. Left and right arrows let you see other camera views.



Picture-in-picture view. Shows a main view and a secondary view when in bed camera view or trailer AUX camera view.

**Note:** Picture-in-picture is on by default and cannot be switched off.



Swap. Press to swap between picture-in-picture views.



Auto. Press to return to auto view.

**Note:** Auto mode is the default setting.

## Hitch Angle Graphic

The hitch angle graphic shows a small representation of your truck and trailer with visual feedback to help you monitor the trailer. The graphic shows two different colored lines for the trailer hitch angle. A black line shows you where your trailer is in relation to your vehicle. The white line represents the amount the trailer can turn based on knob input.

The graphic shows a yellow and red zone for the hitch angle to warn you of a high angle condition that could require you to pull forward to reduce the hitch angle. The angle limits for each zone vary based on the trailer length.

The yellow zone indicates you are approaching the maximum controllable trailer angle for the system. When the trailer enters this zone, it is more difficult to reduce the trailer turn when backing up. It may be necessary to put your vehicle back into drive (D) and pull forward to get the truck and trailer back in line.

The red zone indicates you have exceeded the maximum controllable trailer angle for the system. Immediately stop reversing. Put your vehicle into drive (D) and pull forward until the trailer is no longer in the red zone.

## Setting the Trailer Angle Limit

1. Press **Features** on the touchscreen.
2. Press **Towing**.
3. Press **Manage trailers**.
4. Press **Pro Trailer Backup Assist**.
5. Press **Trailer Angle Limit**.
6. Press a setting.

# Trailer Backup Assistance

---

## ***Normal Control Angle***

Default setting. This provides a balanced limit that returns from a turn to straight backing with minimal change to the trailer direction.

## ***Max Control Angle***

Increases the trailer angle limit close to the maximum controllable angle to allow sharper turns but also causes more change in the trailer direction when straightening out from a turn.

# Trailer Backup Assistance

## TRAILER BACKUP ASSISTANCE – TROUBLESHOOTING

### TRAILER BACKUP ASSISTANCE – INFORMATION MESSAGES

Message	Description
Detecting Trailer Please Wait...	Displays when the system turns on and is initializing.
Pro Trailer Backup Assist™ System is Not Available	A condition exists that prevents the system from turning on. If the message continues to display, visit your authorized dealer to have your vehicle checked.
Pro Trailer Backup Assist™ Driving Required to Initialize Steering Press Knob to Exit	The steering system needs to learn internal parameters to fully enable the feature. Drive your vehicle straight forward above 25 mph (40 km/h) for approximately 5 minutes.
Pro Trailer Backup Assist™ Stop now Maximum trailer angle Press Knob to Exit	Displays when you reach the maximum controllable trailer angle for the system. Place your vehicle in drive (D) and pull forward to get the truck and trailer back to an in-line position. If this message consistently displays, you may need to repeat the trailer calibration. Delete the trailer from the system and repeat the setup and calibration process.
Stop now. Deactivated by trailer angle.	Displays when you exceed the maximum controllable trailer angle for the system. Place your vehicle in drive (D) and pull forward to get your vehicle and trailer back to an in-line position, then activate the system by selecting the connected trailer and following the instructions on the touchscreen. If this message consistently displays, you may need to repeat the trailer setup and calibration. Delete the trailer from the system and repeat the setup and calibration process.
Pro Trailer Backup Assist™ Stop Now Take Control of Steering Wheel	Displays when the system can no longer steer the vehicle and you must take over steering.

## Trailer Backup Assistance

<b>Message</b>	<b>Description</b>
Pro Trailer Backup Assist™ Sensor Not Detected Refer to Owner's Manual Press Knob to Exit	<p>Displays when the system does not detect the sensor. Check the sensor connection, check that there is no damaged wiring between the connector and sensor and check that there is only one sensor connected.</p> <p>If you do not want to use the sensor for this trailer, delete the trailer in the touchscreen then repeat the setup process with the sticker.</p>
Pro Trailer Backup Assist™ Trailer Not Detected. Shift to Park Press Knob to Exit	<p>These messages display when the system does not detect the trailer.</p> <p>If your trailer is setup with a sticker, make sure the rear camera is clean, and the sticker is clearly visible in the camera image. You can also move the trailer forward or backward to change the trailer position and lighting conditions.</p> <p>If your trailer is setup with a sensor, check that the sensor is correctly installed and the trailer length is within the allowed range.</p> <p>If these messages continue to display, visit your authorized dealer to have your vehicle checked.</p>
Pro Trailer Backup Assist™ Trailer Not Detected. Refer to Owner's Manual. Press Knob to Exit	<p>If your trailer is setup with a sticker, make sure the rear camera is clean, and the sticker is clearly visible in the camera image. You can also move the trailer forward or backward to change the trailer position and lighting conditions.</p> <p>If your trailer is setup with a sensor, check that the sensor is correctly installed and the trailer length is within the allowed range.</p> <p>If these messages continue to display, visit your authorized dealer to have your vehicle checked.</p>

## Trailer Backup Assistance

Message	Description
Pro Trailer Backup Assist™ Trailer Not Detected Pull Forward to Initialize Press Knob to Exit	<p>If your trailer is setup with a sticker, this message displays when the camera system cannot detect the trailer and requires trailer movement to enable trailer detection. Drive forward above 2 mph (3 km/h) to initialize the system.</p> <p>If your trailer is setup with a sensor, this message displays when your vehicle has not moved after the trailer sensor is connected or extended operation below 1 mph (1 km/h). Drive forward above 2 mph (3 km/h) to initialize the system.</p>
Pro Trailer Backup Assist™ Stop Now System Not Active Press Knob to Exit	<p>Displays when your vehicle is backing up but the system is not activated. Select the connected trailer on the touchscreen and follow the instructions to activate the system.</p> <p>This message also displays when you back up during the calibration process.</p>
Pro Trailer Backup Assist™ Backup Slowly Turn Knob to Steer Press Knob to Exit	<p>Displays when the system turns on and is available to use.</p>



# Trailer Backup Assistance

---

## TRAILER BACKUP ASSISTANCE – FREQUENTLY ASKED QUESTIONS

### What does it mean if the system does not detect a trailer that is setup with a sticker?

- The system could be having trouble identifying the sticker. The system requires a clear view of the sticker placed on the trailer. You must keep the camera lens and sticker clean for the system to correctly operate. If the system cannot initially detect the trailer, it could be necessary for you to change the lighting conditions by moving your vehicle and trailer or waiting until the conditions change. See **Applying the Trailer Reversing Aid Sticker** (page 388). Deleting the trailer and repeating the setup and calibration could improve performance, but some trailers are not compatible with the sticker and camera system. If the system consistently does not detect the trailer with the sticker setup, you may choose to setup the trailer with a sensor.

**Note:** *The system is designed to be used with the same trailer connection every time you choose the trailer from the touchscreen. When using a different drawbar or a different pin hole on drawbars with more than one, connecting the drawbar to your vehicle affects the trailer position and you may need to repeat the trailer setup and calibration process.*

### Why does the trailer not reverse straight?

- The road conditions, such as road camber and road slope, could affect how straight the system can reverse. You can compensate for the trailer drifting to the right or left by slowly turning the knob until the trailer is following your desired path and then holding the knob in that position.
- Other factors, such as the hitch connection or trailer suspension, could affect how straight the system can reverse the trailer. You can compensate for the trailer drifting to the right or left by slowly turning the knob until the trailer is following your desired path and then holding the knob in that position.
- The sensor could be incorrectly installed. Make sure the sensor is correctly installed.

### What does it mean if the system remains on one message for an extended time during calibration when setting up the system with the sticker?

- The camera could require cleaning.
- You could have a blocked sticker. Verify the sticker is in the proper location. See **Applying the Trailer Reversing Aid Sticker** (page 388).
- The drawbar could be outside of the allowed range of 4–19 in (10–48 cm).

# Trailer Backup Assistance

---

- The system could have difficulties recognizing the sticker based on environmental factors. You could need to move to a different area to change the lighting and background or you could need to change the direction you are driving. You could also try setting up the system at a different time of day.
- Some trailers are not compatible with the sticker and camera system. If the issue persists, set up the trailer with a sensor purchased from your authorized dealer. See **Trailer Sensor Installation** (page 388).

## **What does it mean if the system pauses during calibration?**

- There could be steering input or trailer movement during the straight drive portion of the calibration process.

## **What does it mean if the system displays hold steering steady during turn?**

- Part of the calibration process for the sticker setup requires a steady turn. If you are continually moving the steering wheel during the turn, this delays the calibration process. To enable the calibration process, hold the steering wheel at the same position when turning.

## **What does it mean if the system displays that it is not available?**

- There could be a sub-system that the system uses that is not correctly operating. If the system continues to display it is not available, visit your authorized dealer to have your vehicle checked.
- There could be a battery voltage issue. Make sure the battery is correctly charged. If the system continues to display it is not available, visit your authorized dealer to have your vehicle checked.

## **What does it mean if the system displays that driving is required to initialize steering?**

- The steering system needs to learn internal parameters to fully turn on the feature. Drive your vehicle straight forward above 25 mph (40 km/h) for approximately 5 minutes.
- Your vehicle is new, there is a battery voltage issue or you have serviced the steering system.

## **What does it mean if the system requires you to pull forward to initialize?**

- This occurs when the vehicle has not moved during the current key cycle after you connect and select the trailer in the touchscreen, or you operate the system at speeds below 1 mph (1 km/h) for an extended period of time. Drive forward above 2 mph (3 km/h) and the system indicates when it initializes.

# Trailer Backup Assistance

---

## What does it mean if the trailer is at its maximum angle or the system deactivated by trailer angle?

- You are at the maximum controllable trailer angle for the system. Place your vehicle in drive (D) and pull forward to get the truck and trailer back to an in-line position.
- The trailer could need to be recalibrated. Check that the correct trailer is selected in the touchscreen. Verify the sensor is installed according to the instructions included in the sensor kit and check that the drawbar and the trailer dimensions are within the allowed range. Then, delete the trailer from the system and repeat the setup process to calibrate the trailer.
- The drawbar or the trailer dimensions are outside of the supported range. The system is designed to work with drawbars that have a license plate to hitch ball center measurement of 9–18 in (23–46 cm) when installed. The system is designed to work with trailers that have a hitch point to center of the axle or axles measurement of 6–33 ft (1.85–10.05 m). Do not attempt to use drawbars or trailers that have a length outside of this range as the system performance degrades and could cause improper system function.
- The sensor could be incorrectly installed. Make sure the sensor is correctly installed.

## What does it mean when the system tells you to take control of the steering wheel?

- You have touched the steering wheel when the system is steering. Avoid touching the wheel during system operation.
- You have exceeded the maximum speed for the feature. The system is no longer steering the vehicle and you must take over steering.
- The system does not detect the trailer. The system is no longer steering the vehicle and you must take over steering.
- An internal condition for system operation is not met that requires your vehicle to return to manual control of the steering.

## How do I use a sticker if I have previously setup a trailer with the sensor?

- Disconnect the sensor wiring and add a new trailer to the system and follow the instructions for setup with a sticker. See **Applying the Trailer Reversing Aid Sticker** (page 388). If your vehicle does not support the sticker option, the touchscreen instructs you to install the sensor again.

# Trailer Backup Assistance

---

## Why does the system not detect a sensor?

- There could be an issue with the connection. Make sure that the 12-way connector is fully inserted into the 12-way socket, that the red rubber seal is not visible when the connector is fully inserted and that the wiring harness sensor connection is fully inserted at the trailer sensor.
- The wiring harness could be damaged. Check for damaged wiring between the 12-way connector and the trailer sensor.
- There could be multiple sensors connected to your vehicle. Make sure only one sensor is connected at a time.
- The sensor could be incorrectly installed. Make sure the sensor is installed on a vertical surface with the arrows pointing straight up.

## What does it mean if the system remains on one message for an extended time during calibration when setting up the system with the sensor?

- The trailer length could be outside the allowed range. The system is designed to work with trailers that have a hitch point to center of the axle or axles measurement of 6–33 ft (1.85–10.05 m).
- The road surface could be too rough or bumpy. Try calibrating the system on a smoother road surface, such as an open parking lot.
- The sensor could be incorrectly installed. Make sure the sensor is installed on a vertical surface with the arrows pointing straight up.

## What does it mean if the system does not detect a trailer when configured with a sensor?

- Verify that you properly connected the sensor. See **Trailer Sensor Installation** (page 388). Repeat calibration on a different route if you have verified sensor installation.

## What if I want to use a sensor for the trailer instead of a sticker?

- Install the sensor and connect the sensor wiring before adding the new trailer to the system. You must connect the sensor before you add the trailer. If your vehicle did not come with a sensor, you can purchase one from your authorized dealer.

# Trailer Reverse Guidance

## WHAT IS TRAILER REVERSE GUIDANCE

Trailer reverse guidance provides views and graphics on the touchscreen to help you steer your vehicle when you backup a trailer.

## HOW DOES TRAILER REVERSE GUIDANCE WORK

Trailer reverse guidance uses a sticker or sensor attached to the trailer to detect the trailer angle relative to the towing vehicle and provides instructions, graphics and camera views on the touchscreen.

## TRAILER REVERSE GUIDANCE PRECAUTIONS



**WARNING:** Driving while distracted can result in loss of vehicle control, crash and injury. We strongly recommend that you use extreme caution when using any device that may take your focus off the road. Your primary responsibility is the safe operation of your vehicle. We recommend against the use of any hand-held device while driving and encourage the use of voice-operated systems when possible. Make sure you are aware of all applicable local laws that may affect the use of electronic devices while driving.



**WARNING:** This system is an extra driving aid. It does not replace your attention and judgment, or the need to apply the brakes. This system does NOT automatically brake your vehicle. If you fail to press the brake pedal when necessary, you may collide with another vehicle.

**Note:** The system is not a substitute for safe driving practices. Always be aware of your vehicle and trailer combination, and the surrounding environment.

**Note:** The system does not detect or prevent your vehicle or trailer from making contact with obstacles in the surrounding environment.

**Note:** The front end of your vehicle swings out when changing the direction of the trailer.

**Note:** In certain conditions, the trailer could turn faster or the trailer angle could increase more than anticipated. Always monitor the clearance between the trailer and vehicle and the surroundings.

## SETTING UP TRAILER REVERSE GUIDANCE FOR A CONVENTIONAL TRAILER

### CONFIGURING THE TRAILER

You must configure a trailer in the system to use trailer reverse guidance. This is a one-time setup process and the system saves the trailer information for the next time you use that trailer.

The system only works with conventional trailers. It does not work with other types including fifth wheel and gooseneck. The following illustration shows examples of conventional trailers on the left-hand side.

**Note:** Trailer reverse guidance camera views are available without setting up a trailer. However, complete functionality, including images and automatic view switching, is enabled by setup. Setup is required to enable trailer backup assistance.

# Trailer Reverse Guidance

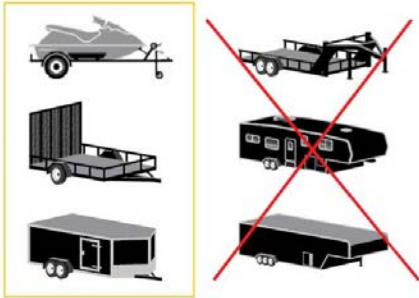

## Positioning the Trailer

Hitch the trailer to your vehicle and connect the electrical wiring harness. Check to make sure that the wiring is working. See **Connecting a Trailer** (page 348).



Park your vehicle and hitched trailer on a level surface.

For best results, make sure that your trailer rides level with the ground when you hitch your vehicle. See **Connecting a Trailer** (page 348).



Make sure that the trailer and your vehicle are in line with each other. You can do this by putting the transmission in drive (D) and pulling straight forward.

## Configuring the Trailer in the Touchscreen

1. Shift to reverse (R).
2. Press the camera view button.
3. Press the trailer view icon.
4. Press **Add Trailer**.
5. Follow the directions on the touchscreen to enter the trailer name and trailer type, then proceed to the sticker or sensor setup.

**Note:** Your vehicle has two options for trailer reverse guidance setup. The system defaults to the camera based system. See **Applying the Trailer Reverse Aid Sticker** (page 402). You can also set up the system with the trailer sensor that you can purchase from your authorized dealer. You must connect a sensor to your vehicle to set up the system. See **Trailer Sensor Installation** (page 403).

**Note:** If you configure the trailer and install a sensor, the system saves the trailer with that sensor information. If you want to use this trailer with the sticker, you need to delete the trailer from the system and repeat the setup process.

## APPLYING THE TRAILER REVERSE AID STICKER

Place the sticker in an area visible by the rear view camera. The entire sticker must be within 4–19 in (10–48 cm) from the center of the hitch ball, as shown in the following illustration.

# Trailer Reverse Guidance

## TRAILER SENSOR INSTALLATION

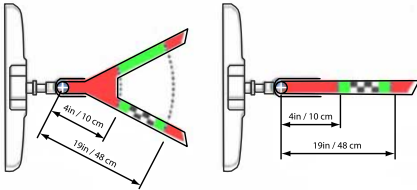

Use the supplied sticker placement card, a tape measure and pen to carefully mark the area to attach the sticker. The sticker is in the back cover pocket of your quick start guide. Make sure the entire sticker is within the green zone between the two arcs or distance markers on the diagram, and is also visible in the rear view camera display.

Once you have found the correct location, place the sticker.

**Note:** Make sure nothing can obstruct the rear view camera's view of the sticker such as a jack handle or wiring.

**Note:** Position the sticker on a flat, dry and clean horizontal surface. For best results, apply the sticker when temperatures are above 32°F (0°C).

**Note:** Do not move stickers after placing them. Do not re-use any stickers if removed.

**Note:** You can purchase additional stickers through your authorized dealer.

**Note:** If you previously setup the trailer with the trailer sensor, make sure it is not plugged in before configuring the trailer and placing the sticker.

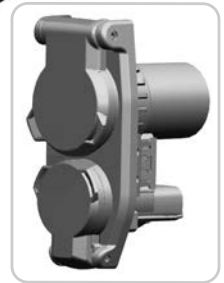
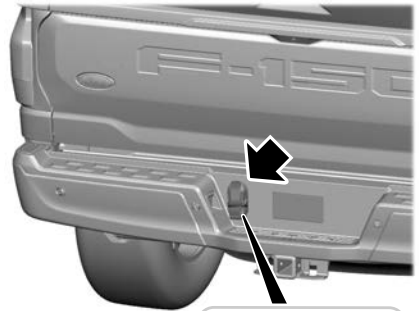

You need to purchase a sensor kit and 7/12 way connector to replace the 7/4 way connector on your vehicle to setup the system with a sensor. See your authorized dealer.

# Trailer Reverse Guidance

Refer to the instructions included with your trailer sensor for detailed information regarding installation.

**Note:** Make sure the arrows on the sensor housing are facing up. Mount the sensor to a vertical part of the trailer that pivots when you turn your vehicle. Do not mount to a stationary surface such as the truck side of the trailer hitch.

**Note:** To setup a trailer with a sensor, install the sensor on the trailer and plug the connector into the connector in your bumper prior to configuring the trailer. Trailers that were set up with a sensor still require the sensor to function. To change a trailer to use the sticker, delete the trailer in the system and repeat the trailer setup with the sticker.

## CALIBRATING THE SYSTEM

Calibrating the system requires driving forward and turning left or right. Follow the instructions on the touchscreen to complete the calibration process.

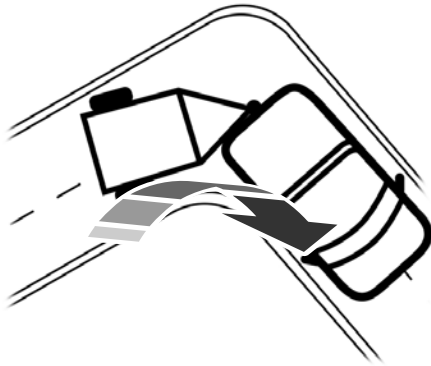

**Note:** To calibrate the system, you need an area where you can safely drive forward and turn left or right. An open parking lot is an ideal place to perform the calibration.

**Note:** Keep the steering wheel straight when instructed to by the touchscreen. If the steering wheel is in a turned position during this instruction, the calibration pauses.

**Note:** During calibration, the system determines the trailer length. The system supports trailer lengths of 6–33 ft (1.85–10.05 m) distance from the hitch point to the center of the axle or axles. The system is designed to work with drawbars that have a license plate to hitch ball center measurement of 9–18 in (23–46 cm) when installed. Do not attempt to use drawbars or trailers that have a length outside of this range as the system performance degrades and could cause improper system function.

**Note:** The touchscreen shows if you are going too slow or fast. Calibration pauses if the speed is outside the required range of 2–9 mph (4–15 km/h).

**Note:** You need to complete at least a 90° turn, and longer trailers could require a 180° turn. Camera trailer tracking requires the system to locate the hitch ball as well as determine the trailer length. Some trailers could require you to drive straight then turn multiple times before calibration completes. The touchscreen provides instructions and notifies you when calibration completes.

**Note:** For best results, do not calibrate the system at night when calibrating the system with the sticker.

## SWITCHING TRAILER REVERSE GUIDANCE ON AND OFF

Shift into reverse (R), press the rear camera button to expand the menu, press the trailer icon and use the touchscreen to select the connected trailer.



# Trailer Reverse Guidance

**Note:** If the trailer was connected just prior to turning the system on, you may need to drive forward to initialize the system. Follow the instructions on the touchscreen to activate the system.

## USING TRAILER REVERSE GUIDANCE VIEWS

Up to seven camera views could be available when using trailer reverse guidance. Use the view that helps you the most when reversing your vehicle and trailer.



360° camera view. Shows a 360° view on the right-hand side of the touchscreen with a rear camera view on the left-hand side of the touchscreen.



Rear view camera view. Shows your trailer hitch or what is directly behind your vehicle.



Rear split view camera view. Shows a 180° degree view of what is behind your vehicle.



Bed camera view. Shows the truck bed.

**Note:** This view also provides a picture-in-picture view.



Trailer AUX camera view. Shows a rear view camera image of what is behind your trailer. You need to separately purchase this camera and have it installed.

**Note:** This view also provides a picture-in-picture view.



Trailer reverse guidance view. Shows you a view of the sides of your truck and the trailer. In auto mode, this view moves as the trailer moves so that you do not have to adjust the camera as you turn. Left and right arrows let you see other camera views.



Straight backup mode. Shows which way to turn your steering wheel to keep the trailer straight. Use this view when you want to keep your trailer completely in line with your truck.

**Note:** This view also provides a picture-in-picture view.

**Note:** It may be helpful to shift your vehicle into drive (D), pull forward and straighten out the vehicle and trailer before engaging straight backup mode.



Picture-in-picture view. Shows a main view and a secondary view when in bed camera view, trailer AUX camera view or straight backup mode.

**Note:** If you have a 8 in (20 cm) touchscreen, picture-in-picture is off by default. Press the picture-in-picture icon on the touchscreen to switch picture-in-picture view on and off.

**Note:** If you have a 12 in (30 cm) touchscreen, picture-in-picture is on by default for bed camera view and trailer AUX camera view and cannot be switched off. Press the picture-in-picture icon on the touchscreen to switch picture-in-picture view on and off in straight backup mode.



Swap. Press to swap between picture-in-picture views.



This takes you back to the 360° camera system and out of the trailer reverse guidance feature.



Auto. Press to return to auto view.

# Trailer Reverse Guidance

---

**Note:** *Auto mode is the default setting.*

## Hitch Angle Graphic

The hitch angle graphic shows a small representation of your truck and trailer with visual feedback to help you monitor the trailer. The graphic shows two different colored lines for the trailer hitch angle. A black line shows you where your trailer is in relation to your vehicle. The white line represents the amount the trailer can turn based on steering wheel position.

The graphic shows a yellow and red zone for the hitch angle to warn you of a high angle condition that could require you to pull forward to reduce the hitch angle. The angle limits for each zone vary based on the trailer length.

The yellow zone indicates you are approaching the maximum controllable trailer angle for the system. When the trailer enters this zone, it is more difficult to reduce the trailer turn when backing up. It may be necessary to put your vehicle back into drive (D) and pull forward to get the truck and trailer back to an in-line position.

The red zone indicates you have exceeded the maximum controllable trailer angle for the system. Immediately stop reversing. Put your vehicle into drive (D) and pull forward until the trailer is no longer in the red zone.

# Trailer Reverse Guidance

## TRAILER REVERSE GUIDANCE – TROUBLESHOOTING

### TRAILER REVERSE GUIDANCE – INFORMATION MESSAGES

Message	Description
Detecting Trailer Please Wait...	Displays when the system turns on and is initializing.
Trailer Reverse Guidance System is Not Available	A condition exists that prevents the system from turning on. If the message continues to display, visit your authorized dealer to have your vehicle checked.
Trailer Reverse Guidance Driving Required to Initialize Steering Press OK to Exit	The steering system needs to learn internal parameters to fully enable the feature. Drive your vehicle straight forward above 25 mph (40 km/h) for approximately 5 minutes.
Stop now. Deactivated by trailer angle.	Displays when you exceed the maximum controllable trailer angle for the system. Place your vehicle in drive (D) and pull forward to get your vehicle and trailer back to an in-line position, then activate the system by selecting the connected trailer and following the instructions on the touchscreen. If this message consistently displays, you may need to repeat the trailer setup and calibration. Delete the trailer from the system and repeat the setup and calibration process.
Trailer Reverse Guidance Sensor Not Detected Refer to Owner's Manual Press OK to Exit	Displays when the system does not detect the sensor. Check the sensor connection, check that there is no damaged wiring between the connector and sensor and check that there is only one sensor connected. If you do not want to use the sensor for this trailer, delete the trailer in the touchscreen then repeat the setup process with the sticker.

## Trailer Reverse Guidance

<b>Message</b>	<b>Description</b>
Trailer Reverse Guidance Trailer Not Detected. Refer to Owner's Manual. Press OK to Exit	Displays when the system does not detect the trailer. If your trailer is setup with a sticker, make sure the rear camera is clean, and the sticker is clearly visible in the camera image. You can also move the trailer forward or backward to change the trailer position and lighting conditions. If your trailer is setup with a sensor, check that the sensor is correctly installed and the trailer length is within the allowed range. If this message continues to display, visit your authorized dealer to have your vehicle checked.
Trailer Reverse Guidance Trailer Not Detected Pull Forward to Initialize Press OK to Exit	Displays when your vehicle has not moved after the trailer sensor is connected or extended operation below 1 mph (1 km/h). Drive forward above 2 mph (3 km/h) to initialize the system.

# Trailer Reverse Guidance

---

## TRAILER REVERSE GUIDANCE – FREQUENTLY ASKED QUESTIONS

### What does it mean if the system does not detect a trailer that is setup with a sticker?

- The system could be having trouble identifying the sticker. The system requires a clear view of the sticker placed on the trailer. You must keep the camera lens and sticker clean for the system to correctly operate. If the system cannot initially detect the trailer, it could be necessary for you to change the lighting conditions by moving your vehicle and trailer or waiting until the conditions change. See **Applying the Trailer Reverse Aid Sticker** (page 402). Deleting the trailer and repeating the setup and calibration could improve performance, but some trailers are not compatible with the sticker and camera system. If the system consistently does not detect the trailer with the sticker setup, you may choose to setup the trailer with a sensor.

**Note:** *The system is designed to be used with the same trailer connection every time you choose the trailer from the touchscreen. When using a different drawbar or a different pin hole on drawbars with more than one, connecting the drawbar to your vehicle affects the trailer position and you may need to repeat the trailer setup and calibration process.*

### Why does the trailer not reverse straight?

- The road conditions, such as road camber and road slope, could affect how straight the system can reverse. You can compensate for the trailer drifting to the right or left by slowly turning the knob until the trailer is following your desired path and then holding the knob in that position.
- Other factors, such as the hitch connection or trailer suspension, could affect how straight the system can reverse the trailer. You can compensate for the trailer drifting to the right or left by slowly turning the knob until the trailer is following your desired path and then holding the knob in that position.
- The sensor could be incorrectly installed. Make sure the sensor is correctly installed.

### What does it mean if the system remains on one message for an extended time during calibration when setting up the system with the sticker?

- The camera could require cleaning.
- You could have a blocked sticker. Verify the sticker is in the proper location. See **Applying the Trailer Reverse Aid Sticker** (page 402).
- The drawbar could be outside of the allowed range of 4–19 in (10–48 cm).

# Trailer Reverse Guidance

---

- The system could have difficulties recognizing the sticker based on environmental factors. You could need to move to a different area to change the lighting and background or you could need to change the direction you are driving. You could also try setting up the system at a different time of day.
- Some trailers are not compatible with the sticker and camera system. If the issue persists, set up the trailer with a sensor purchased from your authorized dealer. See **Trailer Sensor Installation** (page 403).

## What does it mean if the system pauses during calibration?

- There could be steering input or trailer movement during the straight drive portion of the calibration process.

## What does it mean if the system displays hold steering steady during turn?

- Part of the calibration process for the sticker setup requires a steady turn. If you are continually moving the steering wheel during the turn, this delays the calibration process. To enable the calibration process, hold the steering wheel at the same position when turning.

## What does it mean if the system displays that it is not available?

- There could be a sub-system that the system uses that is not correctly operating. If the system continues to display it is not available, visit your authorized dealer to have your vehicle checked.
- There could be a battery voltage issue. Make sure the battery is correctly charged. If the system continues to display it is not available, visit your authorized dealer to have your vehicle checked.

## What does it mean if the system displays that driving is required to initialize steering?

- The steering system needs to learn internal parameters to fully turn on the feature. Drive your vehicle straight forward above 25 mph (40 km/h) for approximately 5 minutes.
- Your vehicle is new, there is a battery voltage issue or you have serviced the steering system.

## What does it mean if the system requires you to pull forward to initialize?

- This occurs when the vehicle has not moved during the current key cycle after you connect and select the trailer in the touchscreen, or you operate the system at speeds below 1 mph (1 km/h) for an extended period of time. Drive forward above 2 mph (3 km/h) and the system indicates when it initializes.

# Trailer Reverse Guidance

---

## What does it mean if the trailer is at its maximum angle or the system deactivated by trailer angle?

- You are at the maximum controllable trailer angle for the system. Place your vehicle in drive (D) and pull forward to get the truck and trailer back to an in-line position.
- The trailer could need to be recalibrated. Check that the correct trailer is selected in the touchscreen. Verify the sensor is installed according to the instructions included in the sensor kit and check that the drawbar and the trailer dimensions are within the allowed range. Then, delete the trailer from the system and repeat the setup process to calibrate the trailer.
- The drawbar or the trailer dimensions are outside of the supported range. The system is designed to work with drawbars that have a license plate to hitch ball center measurement of 9–18 in (23–46 cm) when installed. The system is designed to work with trailers that have a hitch point to center of the axle or axles measurement of 6–33 ft (1.85–10.05 m). Do not attempt to use drawbars or trailers that have a length outside of this range as the system performance degrades and could cause improper system function.
- The sensor could be incorrectly installed. Make sure the sensor is correctly installed.

## What does it mean when the system tells you to take control of the steering wheel?

- You have touched the steering wheel when the system is steering. Avoid touching the wheel during system operation.
- You have exceeded the maximum speed for the feature. The system is no longer steering the vehicle and you must take over steering.
- The system does not detect the trailer. The system is no longer steering the vehicle and you must take over steering.
- An internal condition for system operation is not met that requires your vehicle to return to manual control of the steering.

## How do I use a sticker if I have previously setup a trailer with the sensor?

- Disconnect the sensor wiring and add a new trailer to the system and follow the instructions for setup with a sticker. See **Applying the Trailer Reverse Aid Sticker** (page 402). If your vehicle does not support the sticker option, the touchscreen instructs you to install the sensor again.

# Trailer Reverse Guidance

---

## Why does the system not detect a sensor?

- There could be an issue with the connection. Make sure that the 12-way connector is fully inserted into the 12-way socket, that the red rubber seal is not visible when the connector is fully inserted and that the wiring harness sensor connection is fully inserted at the trailer sensor.
- The wiring harness could be damaged. Check for damaged wiring between the 12-way connector and the trailer sensor.
- There could be multiple sensors connected to your vehicle. Make sure only one sensor is connected at a time.
- The sensor could be incorrectly installed. Make sure the sensor is installed on a vertical surface with the arrows pointing straight up.

## What does it mean if the system remains on one message for an extended time during calibration when setting up the system with the sensor?

- The trailer length could be outside the allowed range. The system is designed to work with trailers that have a hitch point to center of the axle or axles measurement of 6–33 ft (1.85–10.05 m).
- The road surface could be too rough or bumpy. Try calibrating the system on a smoother road surface, such as an open parking lot.
- The sensor could be incorrectly installed. Make sure the sensor is installed on a vertical surface with the arrows pointing straight up.

## What does it mean if the system does not detect a trailer when configured with a sensor?

- Verify that you properly connected the sensor. See **Trailer Sensor Installation** (page 403). Repeat calibration on a different route if you have verified sensor installation.

## What if I want to use a sensor for the trailer instead of a sticker?

- Install the sensor and connect the sensor wiring before adding the new trailer to the system. You must connect the sensor before you add the trailer. If your vehicle did not come with a sensor, you can purchase one from your authorized dealer.



# Driving Hints

---

## OFF-ROAD DRIVING

### WHAT IS OFF-ROAD DRIVING

Off-road driving is driving your vehicle on unsurfaced roads or trails, made from dirt, rocks, sand and mud.

### BASIC OFF-ROAD DRIVING TECHNIQUES

#### Off-road Driving Hints

Before taking your vehicle off-roading, perform a basic vehicle inspection to make sure that the vehicle is in top working condition. It is always recommended that at least two vehicles are used while off-roading. The buddy system helps make sure that help is close at hand should a vehicle become stuck or damaged. It is also wise to take supplies such as a first aid kit, supply of water, tow strap, cell or satellite phone any time an off-road excursion is planned.

1. Grip the steering wheel with thumbs on the outside of the rim. This reduces the risk of injury due to abrupt steering wheel motions that occur when negotiating rough terrain.
2. Make throttle, brake and steering inputs in a smooth and controlled manner. Sudden inputs to the controls can cause loss of traction or upset the vehicle, especially while on loose terrain or while crossing obstacles such as rocks or logs.
3. Look ahead on your route noting upcoming obstacles, or any other factors which may indicate a change in available traction, and adjust the vehicle speed and route accordingly.

4. When driving off-road, if the front or rear suspension is bottoming out and/or excessive contact with the skid-plates is encountered, reduce vehicle speed to avoid potential damage to the vehicle.
5. When with other vehicles, it is recommended that communication is used, and the lead vehicle notify other vehicles of obstacles that could cause potential vehicle damage.
6. Always keep available ground clearance in mind and pick a route that minimizes the risk of catching the underside of the vehicle on an obstacle.
7. When negotiating low speed obstacles, applying light brake pressure in conjunction with the throttle helps prevent the vehicle from jerking and allows you to negotiate the obstacle in a more controlled manner.
8. Off-roading requires a high degree of concentration. Even if your local law does not prohibit alcohol use while driving off-road, Ford strongly recommends against drinking if you plan to off-road.

#### Crossing Obstacles

- Review the path ahead before attempting to cross any obstacle. It is best if the obstacle is reviewed from outside the vehicle so that there is a good understanding of terrain condition both in front of and behind the obstacle.
- Approach obstacles slowly.

# Driving Hints

- If a large obstacle such as a rock cannot be avoided, choose a path that places the rock directly under the tire rather than the undercarriage of the vehicle. This helps prevent damage to the vehicle.
- Cross ditches and washouts at a 45° angle, allowing each wheel to independently cross the obstacle.

## Hill Climbing



**WARNING:** Extreme care should be used when steering the vehicle in reverse down a slope so as not to cause the vehicle to swerve out of control.

- Always attempt to climb a steep hill along the fall line of the slope and not diagonally.
- If the vehicle is unable to make it up the hill, DO NOT attempt to turn back down the slope. Place the vehicle in reverse and slowly back down.
- When descending a steep slope, use the throttle and brake pedals to control your descent speed.

## WATER WADING



**WARNING:** Do not attempt to cross a deep, fast flowing body of water. Failure to follow this instruction could result in the loss of control of your vehicle, personal injury or death.

To avoid damage to your vehicle, reduce your speed as the water depth increases.



- Always determine the depth before attempting a water crossing. Never drive through water that is higher than the bottom of the wheel hubs.
- Slowly proceed and avoid splashing water any more than is necessary.
- Be aware that obstacles and debris may be under the water's surface.
- Keep the doors fully closed during the water crossing.
- After driving through water and as soon as it is safe to do so check the brakes, horn, lights, and steering wheel to confirm those systems are functioning properly.

## AFTER DRIVING YOUR VEHICLE OFF-ROAD



**WARNING:** After off-road use, before returning to the road, check the wheels and tires for damage. Off-road use may cause damage to your wheels and tires that can lead to tire failure, loss of vehicle control, serious injury or death.

# Driving Hints



**WARNING:** Always re-inflate tires to recommended tire pressures before the vehicle is operated on-road. The recommended pressure is located on the tire label or safety certification label, located on the B-pillar, inside the driver's door.

Driving off-road places more stress on your vehicle than most on-road driving. After driving off-road check for damage to your vehicle and, if necessary, have your vehicle fixed as soon as possible.

Inspect the underbody of your vehicle by checking tires, body structure, steering and suspension.

Check the radiator for mud and debris and clean as needed. After an off-road event, inspect and clean your radiator as needed.

With the vehicle off, use a low pressure hose to wash away mud and fine debris. You may need to reach past the active grille shutters to remove larger debris.

Remove any accumulations of plants or brush. These things could be a fire hazard or hide damage to other systems.

After extended operation in mud, sand, water, or similar dirty conditions, inspect the underbody and clean your vehicle as soon as possible.

If you experience unusual vibration after driving in mud, slush or similar conditions, check the wheels for impacted material. Impacted material can cause vibrations while driving and wheel imbalance. Remove the material to resolve the problem.

## COLD WEATHER PRECAUTIONS

The functional operation of some components and systems can be affected at temperatures below approximately  $-13^{\circ}\text{F}$  ( $-25^{\circ}\text{C}$ ).

## DRIVING ON SNOW AND ICE



**WARNING:** If you are driving in slippery conditions that require tire chains or cables, then it is critical that you drive cautiously. Keep speeds down, allow for longer stopping distances and avoid aggressive steering to reduce the chances of a loss of vehicle control which can lead to serious injury or death. If the rear end of your vehicle slides while cornering, steer in the direction of the slide until you regain control of your vehicle.

On ice and snow, you should drive more slowly than usual. Your vehicle has a four wheel anti-lock brake system, do not pump the brake pedal. See **Anti-Lock Braking System Limitations** (page 236).

## BREAKING-IN

Your vehicle requires a break-in period. For the first 1,000 mi (1,600 km), avoid driving at high speeds, heavy braking, aggressive shifting or using your vehicle to tow. During this time, your vehicle may exhibit some unusual driving characteristics.

# Driving Hints

---

## ELECTRIC VEHICLE

### MAXIMIZING YOUR DRIVING RANGE

#### Driving in Cold Weather

Keep your vehicle charged before heading out into cold weather.

Use the heated seats and steering wheel for comfort along with moderate cabin temperature and fan settings to reduce energy needed for climate control.

#### Preconditioning Your Vehicle

You can precondition your vehicle by using the departure and comfort settings to warm or cool the cabin and the high voltage battery when you have your vehicle plugged in. By using energy from the charging source prior to your departure, the system can manage the battery temperature for the best driving performance and use less energy for heating or cooling the cabin at the start of your drive. This helps maximize your driving range. See **Setting the Charging Schedule and Preferences** (page 214).

**Note:** You can also access departure and comfort settings using the FordPass app.

**Note:** Lower cabin temperature settings on the climate control system results in better trip range.

#### Parking Your Vehicle

At temperatures just above the freezing point and lower, plug your vehicle in when not in use to maintain high voltage battery performance.

When possible park your vehicle under a covered area or in a garage. This helps to moderate temperatures which affect the performance of the high voltage battery and requires energy to heat or cool the cabin.

## Driving Style

When you drive aggressively or at consistently high speeds, you reduce the system's detection range. Aggressive driving for extended periods could also result in reducing the battery's efficiency and lifespan. Use the trip application on the touchscreen to see the electric economy and a breakdown of energy usage when driving. Better economy means better range. When the battery is cold at the beginning of your driving, the range may be low even if the trip economy is good. This is due to lower capacity in the cold battery. For the best range and performance, we recommend preconditioning your vehicle using the departure and comfort settings before you drive.

## DRIVING IN COLD WEATHER

Pack a small supply kit with a 12 V jump box, blanket, snow scraper and gloves during winter.

We recommend winter tires with sufficient tread depth for traction.

Clear snow and ice from the roof, hood, all windows and mirrors. Remove piled up snow or ice from the wipers and washer nozzles. Allow time for windows to defrost and interior controls to warm up before driving.

#### Preconditioning Your Vehicle

You can precondition your vehicle to warm or cool the cabin and the high voltage battery when you have your vehicle plugged in. You can charge your vehicle to the targeted level and also make sure your vehicle is at a comfortable temperature for the occupants.

**Note:** You can precondition your vehicle prior to your departure using the FordPass app.

# Driving Hints

Keep your vehicle fully charged before heading out into cold weather.

**Note:** *Using seat heaters is more efficient for warming occupants than using the heat from the climate control.*

**Note:** *Lower cabin temperature settings on the climate control system results in better trip range.*

## FLOOR MATS

**WARNING:** Use a floor mat designed to fit the footwell of your vehicle that does not obstruct the pedal area. Failure to follow this instruction could result in the loss of control of your vehicle, personal injury or death.

**WARNING:** Pedals that cannot move freely can cause loss of vehicle control and increase the risk of serious personal injury.

**WARNING:** Secure the floor mat to both retention devices so that it cannot slip out of position and interfere with the pedals. Failure to follow this instruction could result in the loss of control of your vehicle, personal injury or death.

**WARNING:** Do not place additional floor mats or any other covering on top of the original floor mats. This could result in the floor mat interfering with the operation of the pedals. Failure to follow this instruction could result in the loss of control of your vehicle, personal injury or death.

**WARNING:** Always make sure that objects cannot fall into the driver foot well while your vehicle is moving. Objects that are loose can become trapped under the pedals causing a loss of vehicle control.



To install floor mats that have eyelets, position the floor mat eyelet over the retention post and press down to lock in position. Repeat for all eyelets on the floor mat.

To remove the floor mats, reverse the installation procedure.

**Note:** *Regularly check the floor mats to make sure they are secure.*

# Crash and Breakdown Information

---

## ROADSIDE ASSISTANCE

### Vehicles Sold in the United States: Getting Roadside Assistance

If you have a vehicle concern, Ford Motor Company offers a complimentary roadside assistance program. This program is separate from the New Vehicle Limited Warranty.

The service is available:

- 24 hours a day, seven days a week.
- For the coverage period supplied with your vehicle.

Roadside Assistance covers:

- A flat tire change with a good spare — except for vehicles supplied with a tire inflation kit.
- 12 V battery jump start.
- Lock-out assistance (key replacement cost is the customer's responsibility).
- In the event your vehicle's high-voltage battery does not have enough power to move, you can choose where you would like your vehicle towed (within a 35 mi (56 km) radius):
  - EV Certified Ford or Lincoln Dealer.
  - Nearest public charger.
  - Your home residence.
- Winch out — available within 100 ft (30 m) of a paved or county maintained road, no recoveries.

- Towing — independent service contractors, if not prohibited by state, local or municipal law, shall tow Ford eligible vehicles to an authorized dealer within 35 mi (56 km) of the disablement location or to the nearest authorized dealer. If a member requests a tow to an authorized dealer that is more than 35 mi (56 km) from the disablement location, the member shall be responsible for any mileage costs in excess of 35 mi (56 km).
- Roadside Assistance includes up to \$200 for a towed trailer if the disabled eligible vehicle requires service at the nearest authorized dealer. If the towing vehicle is operational but the trailer is not, then the trailer does not qualify for any roadside services.

### Vehicles Sold in the United States: Using Roadside Assistance

Complete the roadside assistance identification card and place it in your wallet for quick reference. This card is in the Owner's Manual kit.

United States vehicle customers who require Roadside Assistance, call 1-800-241-3673.

If you need to arrange roadside assistance on your own, Ford Motor Company reimburses a reasonable amount for towing to the nearest dealership within 35 mi (56 km). To obtain reimbursement information, United States vehicle customers call 1-800-241-3673. Customers need to submit their original receipts.

### Vehicles Sold in Canada: Getting Roadside Assistance

If you have a vehicle concern, Ford Motor Company of Canada, Limited offers a complimentary roadside assistance program. This program is eligible within Canada or the continental United States.

# Crash and Breakdown Information

---

The service is available 24 hours a day, seven days a week.

This program is separate from the New Vehicle Limited Warranty, but the coverage is concurrent with the powertrain coverage period of your vehicle. Canadian roadside coverage and benefits may differ from the U.S. coverage.

If you require more information, please call us in Canada at 1-800-665-2006, or visit our website at [www.ford.ca](http://www.ford.ca).

## HIGH VOLTAGE BATTERY VEHICLE PRECAUTIONS

In the event of damage or fire involving an electric vehicle or hybrid-electric vehicle:

- Assume the high-voltage battery and associated components are energized and fully charged.
- Physical damage to the vehicle or high-voltage battery could result in immediate or delayed release of toxic, flammable gases and fire.

## Crashes

A crash or impact significant enough to require an emergency response for conventional vehicles would also require the same response for an electric or hybrid-electric vehicle.

If Possible:

1. Move your vehicle to a safe, nearby location and remain on the scene.
2. Roll down the windows before you switch your vehicle off.
3. Place your vehicle in park (P), apply the parking brake, switch off the vehicle, turn on the hazard flashers and move the key at least 16 ft (5 m) away from the vehicle.

Always:

- Call emergency assistance if needed and advise that an electric or hybrid-electric vehicle is involved.
- Avoid contact with leaking fluids and gases, and remain out of the way of oncoming traffic until emergency responders arrive.
- When emergency responders arrive, tell them that the vehicle involved is an electric vehicle or hybrid-electric vehicle.

## Fires

As with any vehicle, call emergency assistance immediately if you see sparks, smoke or flames coming from the vehicle. Remain a safe distance from the vehicle and try to stay clear of the smoke.

1. Exit the vehicle immediately.
2. Advise emergency assistance that an electric or hybrid-electric vehicle is involved.
3. As with any vehicle fire, do not inhale smoke, vapors or gas from the vehicle, as they may be hazardous.

## Post-Incident

1. Do not store a severely damaged vehicle with a lithium-ion battery inside a structure or within 50 ft (15 m) of any structure or vehicle.
2. Make sure that passenger and luggage compartments remain ventilated.
3. As with any vehicle, call emergency assistance immediately if you see sparks, smoke or flames coming from the vehicle.

# Crash and Breakdown Information

## SWITCHING THE HAZARD FLASHERS ON AND OFF

The hazard flashers operate with the power on or off. The battery loses charge and may have insufficient power to restart your vehicle.



The hazard flasher button is on the center console. Press the button to turn on the hazard flashers if your vehicle is creating a safety hazard for other road users.

When you switch the hazard flashers on, all front and rear direction indicators flash. Press the button again to switch them off.

## JUMP STARTING THE VEHICLE

### JUMP STARTING PRECAUTIONS



**WARNING:** Connect batteries with only the same nominal voltage.



**WARNING:** Use only adequately sized cables with insulated clamps.

**Note:** This procedure is only for the 12 volt under hood battery.

**Note:** Your vehicle has a 12 volt battery that is easily accessible under the hood. The 12 volt battery controls the switches and contacts that engage the high voltage battery. Do not jump start the high voltage battery using a standard 12 volt battery. Tow your vehicle to an authorized dealer if the high voltage battery does not accept a regular charge.

**Note:** Do not attempt to push start your vehicle. You could cause transmission damage.

**Note:** Do not disconnect the 12 volt battery from your vehicle electrical system.

## PREPARING THE VEHICLE

Park the booster vehicle close to the hood of the disabled vehicle, making sure the two vehicles do not touch.

### To Connect the Booster Cables



**WARNING:** Do not connect the negative jumper cable to any other part of your vehicle. Use the ground point.

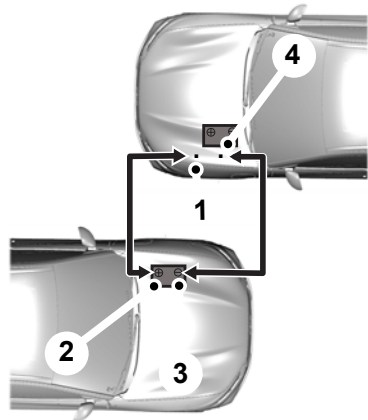

**Note:** Make sure that the cables are clear of any moving parts.



1. Locate the jumper cable symbols on the right-hand side luggage compartment cover.
2. Remove the cover. See **Installing and Removing the Luggage Compartment Cover** (page 338).



# Crash and Breakdown Information

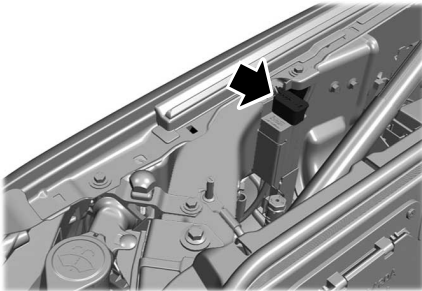

3. Remove the red cap. Connect the positive (+) jumper cable to the positive (+) jump point of the discharged battery vehicle.
4. Connect the other end of the positive (+) jumper cable to the positive (+) terminal of the booster vehicle battery.
5. Connect the negative (-) jumper cable to the negative (-) terminal of the booster vehicle battery.

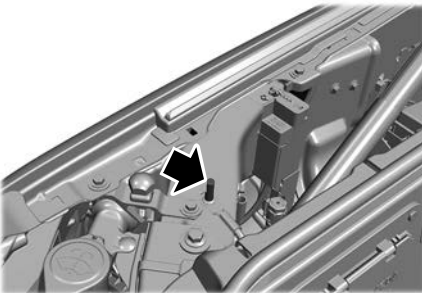

6. Make the final connection of the negative (-) jumper cable to the negative (-) ground point of the discharged battery vehicle.

## JUMP STARTING THE VEHICLE

### To Start Your Vehicle

1. Run the engine of the booster vehicle at a moderately high speed.
2. Move the transmission selector lever of the low charge vehicle to park (P).
3. Switch on the ready to drive mode. See **Starting the Vehicle** (page 194).
4. Run both vehicles for a minimum of three minutes before disconnecting the cables.

**Note:** *Do not switch the headlamps on when disconnecting the cables. The peak voltage could damage the bulbs.*

Disconnect the cables in the reverse order.

## POST-CRASH ALERT SYSTEM

### WHAT IS THE POST-CRASH ALERT SYSTEM

The system helps draw attention to your vehicle in the event of a serious impact.

### HOW DOES THE POST-CRASH ALERT SYSTEM WORK

The system is designed to turn the hazard flashers on and to intermittently sound the horn in the event of a serious impact that deploys an airbag or the seatbelt pretensioners.

### POST-CRASH ALERT SYSTEM LIMITATIONS

Depending on applicable laws in the country your vehicle was built for, the horn does not sound in the event of a serious impact.

# Crash and Breakdown Information

## SWITCHING THE POST-CRASH ALERT SYSTEM OFF

Press the hazard flasher switch or the unlock button on the remote control to switch the system off.

**Note:** *The alert turns off when the vehicle battery runs out of charge.*

## POST IMPACT BRAKING

### HOW DOES POST IMPACT BRAKING WORK

In the event of a moderate to severe crash, the braking system reduces the vehicle's speed in order to prevent or reduce the impact of a potential secondary crash.

### POST IMPACT BRAKING LIMITATIONS

Post impact braking does not activate if any of the following occur:

- The anti-lock braking system is damaged during the collision.
- Electronic stability control is disabled.

### OVERRIDING POST IMPACT BRAKING

You can override post impact braking by pressing the brake or accelerator pedal.

### POST IMPACT BRAKING INDICATORS



It flashes when a post impact braking event is occurring.

## AUTOMATIC CRASH SHUTOFF

### WHAT IS AUTOMATIC CRASH SHUTOFF

The system deactivates the high voltage system if it is a battery or hybrid-electric vehicle, in the event of a moderate or severe crash.

### RE-ENABLING YOUR VEHICLE

1. Switch your vehicle off.
2. Attempt to start your vehicle.
3. Switch your vehicle off.
4. Attempt to start your vehicle.

**Note:** *If your vehicle does not start after the third attempt, have your vehicle checked as soon as possible.*

## RECOVERY TOWING

### ACCESSING THE FRONT TOWING POINT



**WARNING:** Using recovery hooks is dangerous and should only be done by a person familiar with proper vehicle recovery safety practices. Improper use of recovery hooks may cause hook failure or separation from the vehicle and could result in serious injury or death.



**WARNING:** Slowly remove the slack from the recovery strap prior to pulling. Failure to do so can introduce significantly higher loads which can cause the recovery hooks to break off, or the recovery strap to fail which can cause serious injury or death.

# Crash and Breakdown Information



**WARNING:** Never link two straps together with a clevis pin. These heavy metal objects could become projectiles if the strap breaks and can cause serious injury or death.



**WARNING:** Switch the ignition off before removing the recovery hook. Failure to do so could result in personal injury.



**WARNING:** The recovery hook can become hot. Let the recovery hook cool down before removing it. Failure to do so could result in personal injury.

Your vehicle has frame-mounted front recovery hooks.

**Note:** Do not apply a load to the recovery hooks that is greater than the gross vehicle weight rating of your vehicle.

Before using recovery hooks:

- Make sure all attaching points are secure and capable of withstanding the applied load.
- Do not use chains, cables or tow straps with metal hook ends.
- Only use recovery straps that have a minimum breaking strength two to three times the gross vehicle weight of the stuck vehicle.
- Make sure the recovery strap is in good condition and free of visible cuts, tears or damage.
- Use a damper device such as a tarp, heavy blanket or piece of carpet, and place it over the recovery strap to help absorb the energy in the event the strap breaks.
- Make sure the stuck vehicle is not loaded heavier than its gross vehicle weight rating specified on the certification label.

- Align the tow vehicle and stuck vehicle in a straight line, within 10 degrees.
- Keep bystanders to the sides of the vehicle, at a distance of at least twice the length of the recovery strap. This helps avoid injury from the hazard of a recovery hook or strap breaking, or a vehicle lurching into their path.

## TRANSPORTING THE VEHICLE

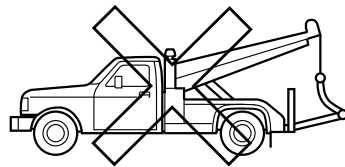
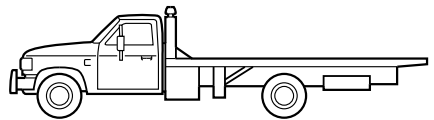
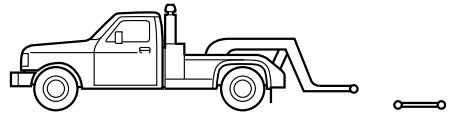

If you need to tow your vehicle, contact a professional towing service or your roadside assistance service provider.

Your manufacturer produces a towing manual for all authorized tow truck operators. Have your tow truck operator refer to this manual for proper hook-up and towing procedures.

## Crash and Breakdown Information

---

We recommend the use of a wheel lift and dollies or flatbed equipment to tow your vehicle. Vehicle damage could occur if towed incorrectly, or by any other means.

Front-wheel and rear-wheel drive vehicles must have their designated drive wheels off the ground regardless of towing direction. Use tow dollies to prevent damage to the transmission.

All-wheel or four-wheel drive vehicles require that all wheels be off the ground using a wheel lift and dollies or flatbed equipment. This prevents damage to the transmission and drive system.

**Note:** *You need to switch on the ignition to unlock the steering.*

**Note:** *Make sure you check the steering column before towing. It could lock if the battery is dead.*

# Towing Your Vehicle

## RECREATIONALLY TOWING YOUR VEHICLE

You cannot recreational tow your vehicle with all wheels on the ground because vehicle or electric drive motor damage could occur. You must recreational tow your vehicle with all four wheels off the ground, such as when using a car-hauling trailer. Otherwise, you cannot recreational tow your vehicle.

## EMERGENCY TOWING - VEHICLES WITH: 12.3 INCH SCREEN

If your vehicle becomes inoperable without access to wheel dollies or a vehicle transport trailer, it can be flat-towed with all wheels on the ground, under the following conditions:

- Your vehicle is facing forward for towing in a forward direction.
- You switch Emergency Tow on.
- Maximum speed is 35 mph (56 km/h).
- Maximum distance is 50 mi (80 km).

### Switching Emergency Tow On

1. Properly secure your vehicle to the tow vehicle.
2. Switch your vehicle on to accessory mode. See **Starting and Powering Off** (page 194).
3. Apply the parking brake.
4. Press **Settings**.
5. Press **Vehicle**.
6. Press and hold Emergency Tow until a confirmation message appears on the touchscreen.
7. Press and hold the brake pedal.
8. Shift into neutral (N).

**Note:** A confirmation message appears in the instrument cluster.

9. Release the parking brake.
10. Switch your vehicle off.

**Note:** Power is required for this procedure and requires the 12V battery to be charged.

### Switching Emergency Tow Off

1. Switch your vehicle on.
2. Press and hold the brake pedal.
3. Shift into park (P). A message displays in the instrument cluster and park (P) displays in the instrument cluster and on the shifter.

## EMERGENCY TOWING - VEHICLES WITH: 15 INCH SCREEN

If your vehicle becomes inoperable without access to wheel dollies or a vehicle transport trailer, it can be flat-towed with all wheels on the ground, regardless of the powertrain and transmission configuration, under the following conditions:

- Your vehicle is facing forward for towing in a forward direction.
- You switch Emergency Tow on.
- Maximum speed is 35 mph (56 km/h).
- Maximum distance is 50 mi (80 km).

### Switching Emergency Tow On

1. Properly secure your vehicle to the tow vehicle.
2. Switching your vehicle on to accessory mode. See **Starting and Powering Off** (page 194).
3. Apply the parking brake.
4. Access the vehicle drawer on the touchscreen.
5. Press **Settings**.

# Towing Your Vehicle

6. Press **Vehicle**.
7. Press and hold Emergency Tow until a confirmation message appears on the touchscreen.
8. Press and hold the brake pedal.
9. Shift into neutral (N).

**Note:** A confirmation message appears in the instrument cluster.

10. Release the parking brake.
11. Switch your vehicle off.

**Note:** Power is required for this procedure and requires the 12V battery to be charged.

## Switching Emergency Tow Off

1. Switch your vehicle on.
2. Press and hold the brake pedal.
3. Shift into park (P). A message displays in the instrument cluster and park (P) displays in the instrument cluster and on the shifter.

## TOWING YOUR VEHICLE – TROUBLESHOOTING

### TOWING YOUR VEHICLE – INFORMATION MESSAGES

Message	Description
Neutral Tow Remove Park Brake for Towing	Displays to remind you to release the parking brake to emergency tow your vehicle.
Neutral Tow Disengaged	Displays when emergency tow is off.
Neutral Tow Engaged Turn Ignition Off for Towing	Displays to remind you to switch off the vehicle to emergency tow your vehicle.
Neutral tow engaged Depress Brake and Select Park to Exit Neutral Tow	Displays to remind you that emergency towing is active. To exit emergency towing, shift to park (P).

# Fuses

## FUSE PRECAUTIONS

 **WARNING:** Always disconnect the battery before servicing high current fuses.

 **WARNING:** To reduce risk of electrical shock, always replace the cover to the power distribution box before reconnecting the battery or refilling fluid reservoirs.

 **WARNING:** Always replace a fuse with one that has the specified amperage rating. Using a fuse with a higher amperage rating can cause severe wire damage and could start a fire.

## UNDER HOOD FUSE BOX

### LOCATING THE UNDER HOOD FUSE BOX

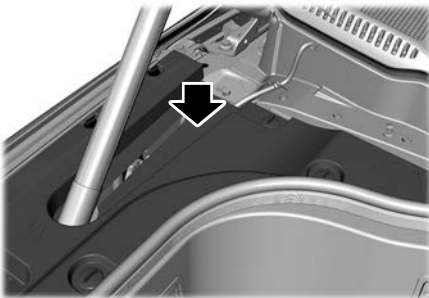

### ACCESSING THE UNDER HOOD FUSE BOX

1. Remove the front luggage compartment cover. See **Installing and Removing the Luggage Compartment Cover** (page 338).

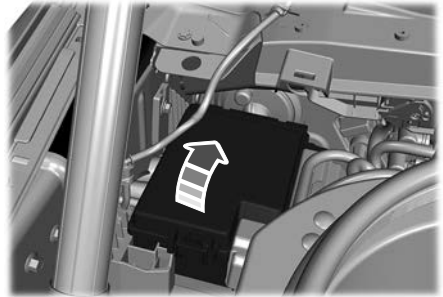

2. Remove the top cover.

# Fuses

## IDENTIFYING THE FUSES IN THE UNDER HOOD FUSE BOX

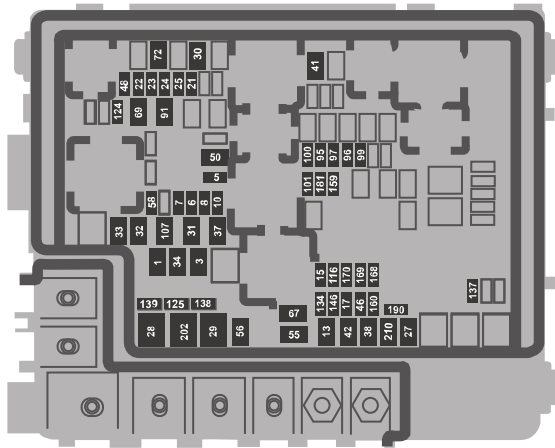

Item	Rating	Protected Component
1	40 A	Body control module.
3	40 A	Body control module.
5	5 A	Primary drive control module. Secondary drive control module.
6	25 A	Powertrain control module.
7	20 A	Powertrain control module heater cooling pump.
8	20 A	A/C control module. Active grille shutter. Front bumper valance motor. Electric fan relay coil.
10	10 A	Auxiliary power point.
13	40 A	Blower motor.
15	25 A	Horn.



# Fuses

<b>Item</b>	<b>Rating</b>	<b>Protected Component</b>
17	5 A	Charge port status indicator.
21	10 A	Not used (spare).
22	10 A	Electronic power assist steering module.
23	10 A	Anti-lock brake system module.
24	10 A	Primary drive control module. Secondary drive control module. Powertrain control module.
25	10 A	Trailer camera module. Trailer tire pressure monitoring system. Trailer sway control.
27	25 A	Primary drive control module fluid pump.
28	50 A	Anti-lock brake system module.
29	50 A	Anti-lock brake system module.
30	40 A	Driver seat module.
31	30 A	Passenger power seat.
32	20 A	Power point.
33	20 A	Not used (spare).
34	20 A	Auxiliary power point.
37	30 A	Power tailgate module.
38	40 A	Climate control module.
41	25 A	Heated rear window.
42	30 A	Trailer brake control module.
46	10 A	Battery charger control module.

# Fuses

<b>Item</b>	<b>Rating</b>	<b>Protected Component</b>
48	20 A	Rear heated seat module.
50	40 A	Heated backlite.
55	30 A	Trailer tow park lamps.
56	20 A	Trailer tow stoplamps.
58	10 A	Trailer tow backup lamps.
67	25 A	Secondary drive control module fluid pump.
69	30 A	Front wiper motor.
72	40 A	Front trunk module.
91	20 A	Trailer tow lighting module.
95	15 A	Primary drive control module.
96	20 A	Coolant pump.
97	10 A	A/C pressure and temperature sensor. High voltage battery cooling module.
99	15 A	Secondary drive control module. High voltage positive temperature coefficient heater.
100	25 A	Left-hand headlamp.
101	25 A	Right-hand headlamp.
107	30 A	Trailer tow lighting module.
116	10 A	Second battery charger control module.
124	5 A	Rain sensor.
125	10 A	USB smart charger 1. USB smart charger 2.
134	25 A	Driver multi-contour seat.

# Fuses

Item	Rating	Protected Component
		Passenger multi-contour seat.
137	20 A	Advanced driver assistance system module. High mounted stoplamp rear video camera.
138	10 A	Tailgate release solenoid.
139	5 A	USB smart charger 3.
146	15 A	Battery energy control module.
159	5 A	Direct current/direct current converter.
160	10 A	Smart datalink connector.
168	15 A	Battery energy control module. Pedestrian sounder.
169	20 A	Coolant pump.
170	20 A	High voltage battery coolant pump.
181	5 A	Headlamp control module.
190	5 A	Not used (spare).
202	60 A	Body control module.
210	30 A	Body control module.

# Fuses

## BODY CONTROL MODULE FUSE BOX

## ACCESSING THE BODY CONTROL MODULE FUSE BOX

### LOCATING THE BODY CONTROL MODULE FUSE BOX

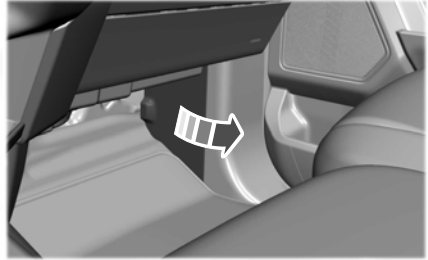
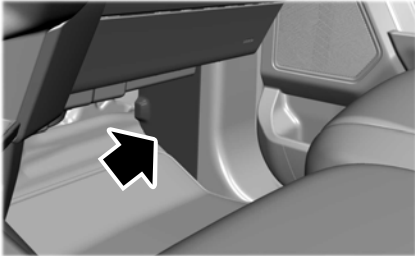

### IDENTIFYING THE FUSES IN THE BODY CONTROL MODULE FUSE BOX

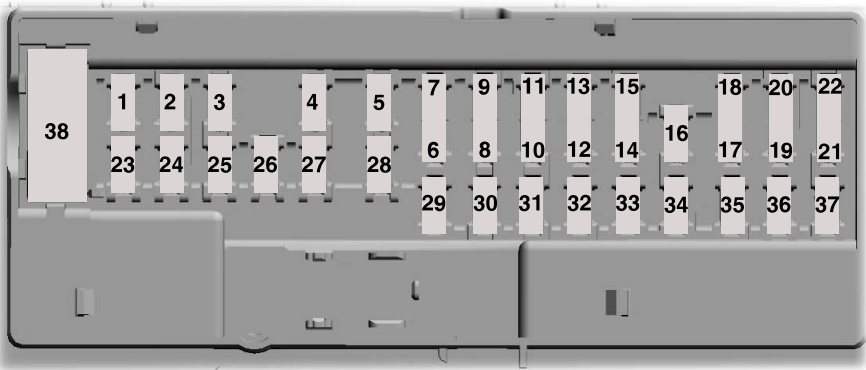

## Fuses

Item	Rating	Protected Component
1	—	Not used.
2	10 A	Driver window switch - delayed accessory feed. Moonroof. Sliding backglass switch.
3	7.5 A	Wireless accessory charging module.
4	20 A	Not used (spare).
5	—	Not used.
6	10 A	Driver window switch - powered at all times.
7	10 A	Gearshift module.
8	5 A	Telematics control module. Power tailgate control module.
9	5 A	Inclination sensor.
10	—	Not used.
11	—	Not used.
12	7.5 A	Climate control module.
13	7.5 A	Instrument cluster. Steering column control module.
14	15 A	Frunk module.
15	15 A	Integrated control module. Accessory protocol interface module.
16	—	Not used.
17	7.5 A	Not used (spare).
18	7.5 A	Not used (spare).
19	5 A	Headlamp switch. Bluetooth low energy module.

## Fuses

Item	Rating	Protected Component
20	5 A	Start switch.
21	5 A	Trailer brake switch.
22	5 A	Not used (spare).
23	30 A	Driver door control module.
24	30 A	Moonroof. Sunshade module.
25	20 A	Not used (spare).
26	30 A	Passenger door control module.
27	30 A	Not used (spare).
28	30 A	Amplifier.
29	15 A	Adjustable pedal switch. 12" display. 15" display.
30	5 A	Not used (spare).
31	10 A	Driver status monitor. Radio transceiver.
32	20 A	Radio Enhanced central gateway.
33	—	Not used.
34	30 A	Run/start relay.
35	5 A	Not used (spare).
36	15 A	Rear heated seat module. Steering column control module. Auto-dimming mirror.
37	20 A	Not used (spare).
38	30 A	Rear window switches.

# Fuses

## IDENTIFYING FUSE TYPES

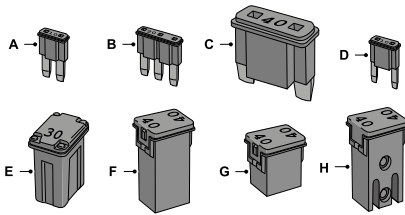

- A Micro 2.
- B Micro 3.
- C Maxi.
- D Mini.
- E M Case.
- F J Case.
- G J Case Low Profile.
- H Slotted M Case.

## FUSES – TROUBLESHOOTING

### FUSES – FREQUENTLY ASKED QUESTIONS

#### When do I need to check a fuse?

If electrical components in the vehicle are not working.

#### When do I need to replace a fuse?

If a fuse has blown.

#### How do I identify a blown fuse?

You can identify a blown fuse by a broken wire within the fuse.

# Maintenance

## MAINTENANCE PRECAUTIONS

Have your vehicle serviced regularly to help maintain its roadworthiness and resale value. There is a large network of authorized dealers that are there to help you with their professional servicing expertise. We believe that their specially trained technicians are best qualified to service your vehicle properly and expertly. They are supported by a wide range of highly specialized tools developed specifically for servicing your vehicle.

If your vehicle requires professional service, an authorized dealer can provide the necessary parts and service. Check your warranty information to find out which parts and services are covered.

Use only recommended fluids and service parts conforming to specifications. See **Capacities and Specifications** (page 480).

## OPENING AND CLOSING THE HOOD

See **Opening the Frunk from Inside Your Vehicle** (page 334).

## UNDER HOOD OVERVIEW

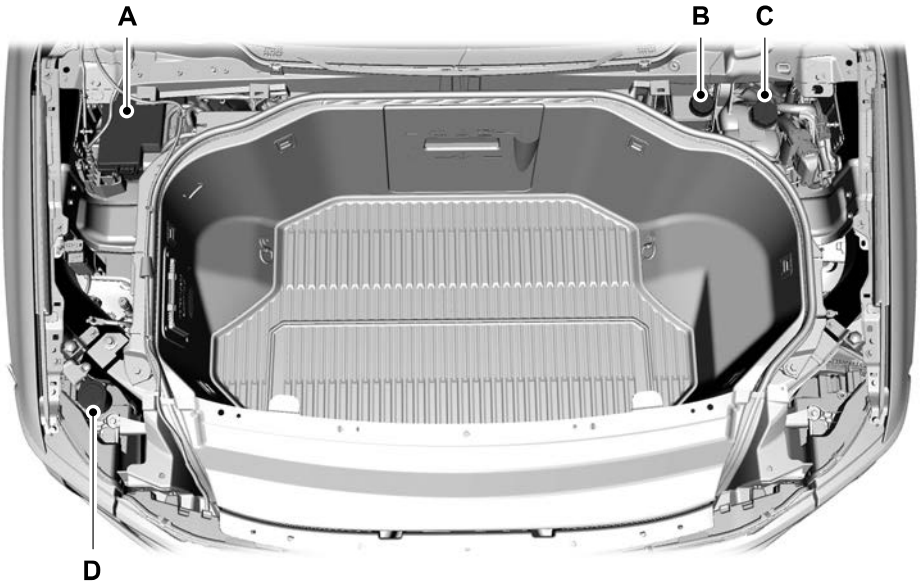



# Maintenance

- A Under hood fuse box. See **Under Hood Fuse Box** (page 427).
- B Brake fluid reservoir. See **Checking the Brake Fluid** (page 236).
- C Motor electronic coolant reservoir. See **Checking the Coolant** (page 437).
- D Windshield washer fluid reservoir. See **Adding Washer Fluid** (page 113).

**Note:** *Some of these components are underneath the luggage compartment cover and cannot be seen unless the cover is removed. See **Installing and Removing the Luggage Compartment Cover** (page 338).*

## CHECKING THE COOLANT



**WARNING:** Do not add coolant when the vehicle is on or the cooling system is hot. Failure to follow this instruction could result in personal injury.



**WARNING:** Do not remove the coolant reservoir cap when the vehicle is on or the cooling system is hot. Wait 10 minutes for the cooling system to cool down. Cover the coolant reservoir cap with a thick cloth to prevent the possibility of scalding and slowly remove the cap. Failure to follow this instruction could result in personal injury.



**WARNING:** Do not put coolant in the windshield washer reservoir. If sprayed on the windshield, coolant could make it difficult to see through the windshield.



**WARNING:** Do not add coolant further than the **MAX** mark.

**Note:** *Coolant expands when it is hot. The level may extend beyond the **MAX** mark.*

Your vehicle has a cooling system reservoir. See **Under Hood Overview** (page 436). Remove the luggage compartment driver side beauty cover to access the reservoir. See **Installing and Removing the Luggage Compartment Cover** (page 338).

When the electric motor is cold, check the concentration and level of the coolant at the intervals listed in the scheduled maintenance information. See **Scheduled Maintenance** (page 561).

Maintain coolant concentration within 48% to 50%, which equates to a freeze point between -29--35°F (-34--37°C). Check coolant concentration using a refractometer. We do not recommend the use of hydrometers or coolant test strips for measuring coolant concentration.

## Adding Coolant

It is very important to use prediluted coolant approved to the correct specification in order to avoid plugging the small passageways in the electric motor cooling system. See **Cooling System Capacity and Specification** (page 480).

Do not mix different colors or types of coolant in your vehicle. Mixing of coolants or using an incorrect coolant may harm the electric motor or cooling system components and may cause damage that the vehicle warranty may not cover.

**Note:** *Automotive fluids are not interchangeable.*

**Note:** *Do not use stop leak pellets, cooling system sealants, or non-specified additives as they can cause damage to the electric motor cooling or heating systems.*

# Maintenance

---

**Note:** *If prediluted coolant is not available, use the approved concentrated coolant diluting it to 50/50 with distilled water. See*

**Cooling System Capacity and Specification** (page 480). *Using water that has not been deionized could contribute to deposit formation, corrosion and plugging of the small cooling system passageways.*

**Note:** *Coolants marketed for all makes and models might not meet our specifications and could cause damage to the cooling system. Resulting component damage could void the vehicle warranty.*

If the coolant level is at or below the minimum mark, add prediluted coolant immediately.

To top up the coolant level do the following:

1. Unscrew the cap slowly. Any pressure escapes as you unscrew the cap.
2. Add prediluted coolant approved to the correct specification. See **Cooling System Capacity and Specification** (page 480).
3. Add enough prediluted coolant to reach the correct level.
4. Replace the coolant reservoir cap. Turn the cap clockwise until it contacts the hard stop.
5. Check the coolant level in the coolant reservoir the next few times you drive your vehicle. If necessary, add enough prediluted coolant to bring the coolant level to the correct level.

If you have to add more than 1.1 qt (1 L) of coolant per month, have your vehicle checked as soon as possible. Operating your vehicle with a low level of coolant can result in overheating and possible electric motor damage.

In case of emergency, you can add a large amount of water without coolant in order to reach a vehicle service location. In this instance, have qualified personnel do the following as soon as possible:

1. Drain the cooling system.
2. Chemically clean the coolant system.
3. Refill with coolant.

Water alone, without coolant, can cause damage from corrosion, overheating or freezing.

Do not use the following as a coolant substitute:

- Alcohol.
- Methanol.
- Brine.
- Any coolant mixed with alcohol or methanol antifreeze.

Alcohol and other liquids can cause damage from overheating or freezing.

Do not add extra inhibitors or additives to the coolant. These can be harmful and compromise the corrosion protection of the coolant.

## Recycled Coolant

We do not recommend the use of recycled coolant, as an approved recycling process is not yet available.

Dispose of used coolant in an appropriate manner. Follow your community's regulations and standards for recycling and disposing of automotive fluids.

# Maintenance

---

## Severe Climates

If you drive in extremely cold climates:

- It may be necessary to increase the coolant concentration above 50%.
- A coolant concentration of 60% provides improved freeze point protection.
- Coolant concentrations above 60% decrease the overheat protection characteristics of the coolant and may cause damage to the electric motor.

If you drive in extremely hot climates:

- You can decrease the coolant concentration to 40%.
- A coolant concentration of 40% provides improved overheat protection.
- Coolant concentrations below 40% decrease the overheat and corrosion protection characteristics of the coolant and may cause damage to the electric motor.

## Coolant Change

Change the coolant at specific mileage intervals listed in the scheduled maintenance information. Add prediluted coolant approved to the correct specification. See **Cooling System Capacity and Specification** (page 480).

## 12V BATTERY

### CHANGING THE 12V BATTERY

If the 12 volt battery needs servicing, see your authorized dealer.

### CHARGING THE 12V BATTERY

Your vehicle has a high voltage to low voltage energy transfer feature that keeps the 12 volt battery charged by the high voltage battery. If the 12 volt battery level is low, the high voltage battery transfers energy to the 12 volt battery when the vehicle is off.

### 12V BATTERY – TROUBLESHOOTING

### 12V BATTERY – WARNING LAMPS



If it illuminates when the green ready to drive indicator is activated, this indicates your vehicle requires service. Have your vehicle checked as soon as possible.

# Maintenance

## 12V BATTERY – INFORMATION MESSAGES

Message	Action
12V Battery Fault Service Soon	Your vehicle has a 12 volt battery problem. We recommend having the battery system checked by an authorized EV dealer.
Electric Range Reduced due to Park/Hazard Lamps On While Vehicle Off	The electric vehicle range is reduced due to the park and/or hazard lamps on while your vehicle was off.
Electrical System Drain Service Required	Your vehicle has an electrical drain within the vehicle. Please check for any after-market devices that could be draining the battery. If none are found, please have your vehicle serviced by an authorized EV dealer.

## ADJUSTING THE HEADLAMPS

### Vertical Aim Adjustment

The headlamps on your vehicle are properly aimed at the assembly plant. If your vehicle has been in an accident, have the alignment of your headlamps checked by an authorized dealer.

### Headlamp Aiming Target

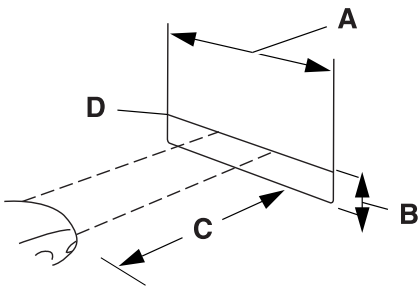

- A 8 feet (2.4 meters)
- B Center height of lamp to ground
- C 25 feet (7.6 meters)
- D Horizontal reference line

### Vertical Aim Adjustment

1. Park your vehicle on a level surface approximately 25 ft (7.6 m) away from a vertical wall or screen.
2. Apply the parking brake.
3. Measure the height from the center of your headlamp to the ground.

**Note:** *There may be an identifying mark on the lens to help you locate the center of the headlamp low beam light.*

4. Mark a horizontal reference line on the wall or screen that is a minimum of 8 ft (2.4 m) long.
5. Switch the low beam headlamps on and open the hood.

# Maintenance

---

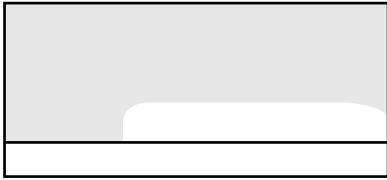

6. On the wall or screen you will see a flat zone of high intensity light located at the bottom of the beam pattern. If the bottom edge of the high intensity light zone is not at the horizontal reference line, the headlamp needs to be adjusted.

**Note:** *To see a clearer light pattern while adjusting one headlamp, block the light from the other headlamp.*



7. Locate the vertical adjuster on each headlamp. Use a Phillips #2 screwdriver to turn the adjuster either clockwise or counterclockwise to adjust the vertical aim of the headlamp.
8. Repeat Steps 3 through 7 to adjust the other headlamp.
9. Close the hood and switch off the headlamps.

## EXTERIOR BULBS

### EXTERIOR BULB SPECIFICATION CHART

**Note:** *LED lamps are not serviceable. See an authorized dealer if they fail.*

## INTERIOR BULBS

### INTERIOR BULB SPECIFICATION CHART

Your vehicle has LED lamps. These are not serviceable items. See an authorized dealer if they fail.

# Vehicle Care

## CLEANING PRODUCTS

### Materials

For best results, use the following products

or products of equivalent quality:

For additional information and assistance, we recommend that you contact an authorized dealer.

Name	Specification
Motorcraft® Bug and Tar Remover, ZC-42 (U.S. & Canada)	
Motorcraft® Custom Bright Metal Cleaner, ZC-15 (U.S. & Canada)	ESR-M5B194-B
Motorcraft® Detail Wash, ZC-3-A (U.S. & Canada)	ESR-M14P4-A
Motorcraft® Premium Leather and Vinyl Cleaner, ZC-56 (U.S. & Canada)	
Motorcraft® Multi-Purpose Cleaner, CXC-101 (Canada)	
Motorcraft® Premium Windshield Wash Concentrate with Bitterant, ZC-32-B2 (U.S.)	WSS-M14P19-A
Motorcraft® Premium Quality Windshield Washer Fluid, CXC-37-F/M (Canada)	WSS-M14P19-A
Motorcraft® Professional Strength Carpet & Upholstery Cleaner, ZC-54 (U.S. & Canada)	
Motorcraft® Premium Glass Cleaner, CXC-100 (Canada)	ESR-M14P5-A
Motorcraft® Spot and Stain Remover, ZC-14 (U.S.)	
Motorcraft® Ultra-Clear Spray Glass Cleaner, ZC-23 (U.S.)	ESR-M14P5-A
Motorcraft® Wheel and Tire Cleaner, ZC-37-A (U.S. & Canada)	

## CLEANING THE EXTERIOR

### CLEANING THE EXTERIOR PRECAUTIONS

Immediately remove fuel spillages, additive residuals, bird droppings, insect deposits and road tar. These may cause damage to your vehicle's paintwork or trim over time. Remove any exterior accessories, for example antennas, before entering a car wash.

## CLEANING HEADLAMPS AND REAR LAMPS

We recommend that you only use cold or lukewarm water containing car shampoo to clean the headlamps and the rear lamps.

Do not scrape the lamps.

Do not wipe lamps when they are dry.

# Vehicle Care

---

## CLEANING WINDOWS AND WIPER BLADES

To clean the windshield and wiper blades:

- Clean the windshield with a non-abrasive glass cleaner.

**Note:** *When cleaning the interior of the windshield, avoid getting any glass cleaner on the instrument panel or door panels. Wipe any glass cleaner off these surfaces immediately.*

- Clean the wiper blades with washer fluid or water applied with a soft sponge or cloth.

**Note:** *Do not use razor blades or other sharp objects to clean or remove decals from the inside of the heated rear window. This can cause damage not covered by the vehicle Warranty.*

## CLEANING CHROME, ALUMINIUM OR STAINLESS STEEL

We recommend that you only use a car shampoo, a soft cloth and water on bumpers and other chrome, aluminium or stainless steel parts.

**Note:** *For additional information and assistance, we recommend that you contact an authorized dealer.*

**Note:** *Rinse the area well after cleaning.*

**Note:** *Do not use abrasive materials, for example steel wool or plastic pads, as they can scratch these surfaces.*

**Note:** *Do not use chrome cleaner, metal cleaner or polish on wheels or wheel covers.*

## CLEANING WHEELS

Only use a recommended wheel and tire cleaner to clean the wheels weekly. For additional information and assistance, we recommend that you contact an authorized dealer.

1. Use a sponge to remove heavy deposits of dirt and brake dust.
2. Rinse well after cleaning.

**Note:** *Do not apply a cleaning chemical to warm or hot wheel rims and covers.*

If you intend on parking your vehicle for an extended period after cleaning the wheels with a wheel cleaner, drive your vehicle for a few minutes before parking your vehicle. This reduces the risk of corrosion of the brake discs, brake pads and linings.

Do not clean the wheels when they are hot.

**Note:** *Some car washes could damage wheel rims and covers.*

**Note:** *Using non-recommended cleaners, harsh cleaning products, chrome wheel cleaners or abrasive materials could damage wheel rims and covers.*

## CLEANING STRIPES OR GRAPHICS

It is recommended to wash your vehicle by hand however, pressure washing may be used under the following conditions:

- Use a spray with a 40° wide spray angle pattern.
- Keep the nozzle at a 12 in (305 mm) distance and 90° angle to your vehicle's surface.
- Do not use water pressure higher than 2,000 psi (14,000 kPa).
- Do not use water hotter than 179°F (82°C).

**Note:** *Holding the pressure washer nozzle at an angle to the vehicle's surface may damage graphics and cause the edges to peel away from the vehicle's surface.*

# Vehicle Care

## CLEANING CAMERA LENSES AND SENSORS

We recommend that you only use lukewarm or cold water and a soft cloth to clean the camera lens and sensors.

**Note:** Do not pressure wash camera lens and sensors.

## CLEANING THE UNDERBODY

Flush the complete underside of your vehicle frequently. Keep body and door drain holes free from packed dirt.

Rear suspension components may require regular cleaning with a power washer or a thorough rinse with a strong stream of water if the vehicle is operated in dusty or muddy environments. Rear leaf springs or other suspension components may emit squeaking or popping noises while operating the vehicle if particles, such as dirt, rocks, or other debris, are present in the components.

## CLEANING THE INTERIOR

### CLEANING THE INSTRUMENT PANEL



**WARNING:** Do not use chemical solvents or strong detergents when cleaning the steering wheel or instrument panel to avoid contamination of the airbag system.

We recommend that you only clean the instrument panel and cluster lens with a damp soft cloth. Dry the area with a clean, soft cloth.

For additional information and assistance, we recommend that you contact an authorized dealer.

**Note:** Avoid cleaners or polishes that increase the gloss of the upper portion of the instrument panel. The dull finish in this area helps protect you from undesirable windshield reflection.

## CLEANING PLASTIC

We recommend that you only use a mild soap and water solution on a soft cloth. Dry the area with a clean, soft cloth.

## CLEANING DISPLAYS AND SCREENS

We recommend that you only use a microfiber cloth in a circular motion to clean off the fingerprint or dust.

If dirt or fingerprints are still on the screen, apply a small amount of alcohol to the cloth and try to clean it again.

**Note:** Do not pour or spray alcohol onto the touchscreen.

**Note:** Do not use detergent or any type of solvent to clean the touchscreen.

## CLEANING FABRIC



**WARNING:** On vehicles equipped with seat-mounted airbags, do not use chemical solvents or strong detergents. Such products could contaminate the side airbag system and affect performance of the side airbag in a crash.

We recommend that you only clean fabric in the following way:

1. Remove dust and loose dirt with a vacuum cleaner.
2. Wipe the surface with a soft, damp cloth and a mild soap and water solution. Dry the area with a clean, soft cloth.



# Vehicle Care

3. For additional information and assistance, we recommend that you contact an authorized dealer.

For heavy stains, spot clean the area. If a ring forms on the fabric, clean the entire area immediately, but do not oversaturate or the ring could set.

## CLEANING LEATHER



**WARNING:** On vehicles equipped with seat-mounted airbags, do not use chemical solvents or strong detergents. Such products could contaminate the side airbag system and affect performance of the side airbag in a crash.

We recommend that you only clean the leather surfaces in the following way:

1. Remove dust and loose dirt with a vacuum cleaner.
2. Wipe the surface with a soft, damp cloth and a mild soap and water solution. Dry the area with a clean, soft cloth.
3. Make sure the leather is dry, then apply a small amount of conditioner to a clean, dry cloth.
4. Rub the conditioner into the leather until it disappears. Allow the conditioner to dry, then repeat the process for the entire interior. If a film appears, wipe it off with a dry, clean cloth.
5. For additional information and assistance, we recommend that you contact an authorized dealer.

## CLEANING VINYL



**WARNING:** On vehicles equipped with seat-mounted airbags, do not use chemical solvents or strong detergents. Such products could contaminate the side airbag system and affect performance of the side airbag in a crash.

We recommend that you only clean vinyl surfaces in the following way:

1. Remove dust and loose dirt with a vacuum cleaner.
2. Wipe the surface with a soft, damp cloth and a mild soap and water solution. Dry the area with a clean, soft cloth.
3. For additional information and assistance, we recommend that you contact an authorized dealer.

## CLEANING CARPETS AND FLOOR MATS

We recommend that you only clean your carpets in the following way:

1. Remove dust and loose dirt with a vacuum cleaner.
2. Wipe the surface with a soft, damp cloth and a mild soap and water solution. Dry the area with a clean, soft cloth.
3. For additional information and assistance, we recommend that you contact an authorized dealer.

For heavy stains, spot clean the area. If a ring forms on the fabric, clean the entire area immediately, but do not oversaturate or the ring could set.

We recommend that you only clean your floor mats in the following way:

# Vehicle Care

1. Remove dust and loose dirt with a vacuum cleaner.
2. Wash rubber floor mats using mild soap and lukewarm or cold water.
3. Completely dry the floor mat before placing them back in your vehicle.

## CLEANING SEATBELTS



**WARNING:** Do not use cleaning solvents, bleach or dye on the vehicle's seatbelts, as these actions may weaken the belt webbing.

1. Wipe the surface with a soft, damp cloth and a mild soap and water solution. Dry the area with a clean, soft cloth.

## Washout Zone

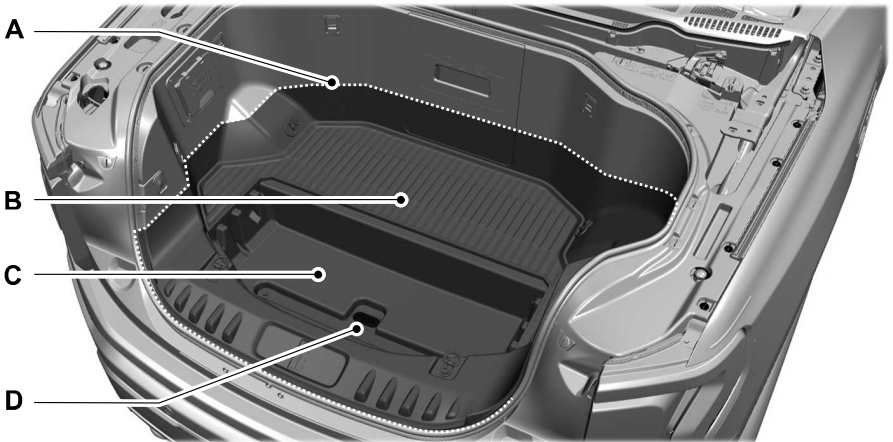

## CLEANING THE LUGGAGE COMPARTMENT

When cleaning the luggage compartment, park your vehicle on a level surface.

### Front Luggage Compartment

Do not aim a water hose, power washer or high-powered spray nozzle directly at the power outlet cover when cleaning the front luggage compartment.

If the front power outlet gets wet, a ground fault could occur. See **Resetting Ground Fault Detection** (page 187).

### Washout Zone

The front luggage compartment has a washout zone that can be washed using a standard garden hose without a nozzle attachment.

The top of the washout zone is 4 in (100 mm) above the upper compartment bottom surface.

# Vehicle Care

---

- A Top of the washout zone.
- B Upper compartment bottom surface.
- C Lower compartment bottom surface.
- D Drain.

The drain is designed to allow small debris to pass through. Remove any large debris by hand.

## CLEANING MOONROOF TRACKS

1. Remove debris from the tracks with a vacuum cleaner.
2. Wipe the bulb seal and mating painted roof metal surface with a soft, damp cloth and a mild soap and water solution.

**Note:** *The moonroof rail tracks are greased to maintain proper functionality. Do not wipe off the grease.*

## REPAIRING MINOR PAINT DAMAGE

Authorized dealers have touch-up paint to match your vehicle's color. Your vehicle color code is printed on a sticker on the front, left-hand side door jamb. Take your color code to your authorized dealer to make sure you get the correct color.

Before repairing minor paint damage, use a cleaner to remove particles such as bird droppings, tree sap, insect deposits, tar spots, road salt and industrial fallout.

Read the instructions before using cleaning products.

## WAXING YOUR VEHICLE

Wax the high-gloss painted surface of your prewashed vehicle once or twice a year.

We recommend that you only use an approved quality wax that does not contain abrasives. Follow the manufacturer's instructions to apply and remove the wax. For additional information and assistance, we recommend that you contact an authorized dealer.

When washing and waxing, park your vehicle in a shaded area out of direct sunlight.

**Note:** *Avoid waxing unpainted or low-gloss black colored parts, they discolor over time.*

# Storing Your Vehicle

---

## PREPARING YOUR VEHICLE FOR STORAGE

If you plan on storing your vehicle for 30 days or more, read the following maintenance recommendations to make sure your vehicle stays in good operating condition.

We engineer and test all vehicles and their components for reliable, regular driving. Under various conditions, long-term storage may lead to degraded performance or failure unless you use specific precautions to preserve vehicle components.

### General

- Store all vehicles in a dry, ventilated place.
- Protect from sunlight, if possible.
- If vehicles are stored outside, they require regular maintenance to protect against rust and damage.

### Body

- Wash your vehicle thoroughly to remove dirt, grease, oil, tar or mud from exterior surfaces, rear-wheel housing and the underside of front fenders.
- Periodically wash your vehicle if it is stored in exposed locations.
- Touch-up exposed or primed metal to prevent rust.
- Cover chrome and stainless steel parts with a thick coat of auto wax to prevent discoloration. Re-wax as necessary when you wash your vehicle.
- Lubricate all hood, door and luggage compartment hinges and latches with a light grade oil.
- Cover interior trim to prevent fading.
- Keep all rubber parts free from oil and solvents.

### Cooling system

- Protect against freezing temperatures.
- When removing your vehicle from storage, check coolant fluid level. Confirm that there are no cooling system leaks and that fluid is at the recommended level.

### Battery Systems

We recommend the following actions for your vehicle:

- When storing your vehicle for greater than 30 days the state of charge should be approximately 50%. Additionally, we recommend disconnecting the 12v battery which will reduce system loads on the HV battery.

**Note:** *Make sure the vehicle has been switched off and doors closed for at least five minutes before disconnecting the 12 volt battery.*

### Brakes

- Make sure the brakes and parking brake release fully.

### Tires

- Maintain recommended air pressure.

### Miscellaneous

- Make sure all linkages, cables, levers and pins under your vehicle are covered with grease to prevent rust.
- Move vehicles at least 25 ft (7.5 m) every 15 days to lubricate working parts and prevent corrosion.

# Storing Your Vehicle

---

## REMOVING YOUR VEHICLE FROM STORAGE

When your vehicle is ready to come out of storage, do the following:

- Wash your vehicle to remove any dirt or grease film build-up on window surfaces.
- Check windshield wipers for any deterioration.
- Check tire pressures and set tire inflation per the Tire Label.
- Check brake pedal operation. Drive your vehicle 15 ft (4.5 m) back and forth to remove rust build-up.
- Check coolant levels to make sure there are no leaks, and fluids are at recommended levels.
- If you removed the 12 volt battery, clean the 12 volt battery cable ends and check for damage.

Contact an authorized dealer if you have any concerns or issues.

# Wheel and Tire Information

## LOCATING THE TIRE LABEL

You will find a Tire Label containing tire inflation pressure by tire size and other important information located on the B-Pillar or the edge of the driver's door. See **Locating the Safety Compliance Certification Labels** (page 329).

## DEPARTMENT OF TRANSPORTATION UNIFORM TIRE QUALITY GRADES



Tire Quality Grades apply to new pneumatic passenger car tires. The Quality grades can be found where applicable on the tire sidewall between tread shoulder and maximum section width. For example: **Treadwear 200 Traction AA Temperature A.**

These Tire Quality Grades are determined by standards that the United States Department of Transportation has set.

Tire Quality Grades apply to new pneumatic passenger car tires. They do not apply to deep tread, winter-type snow tires, space-saver or temporary use spare tires, light truck or LT type tires, tires with nominal rim diameters of 10 to 12 inches or limited production tires as defined in Title 49 Code of Federal Regulations Part 575.104 (c)(2).

**U.S. Department of Transportation Tire quality grades:** The U.S. Department of Transportation requires us to give you the following information about tire grades exactly as the government has written it.

### Treadwear

The treadwear grade is a comparative rating based on the wear rate of the tire when tested under controlled conditions on a specified government test course. For example, a tire graded 150 would wear 1½ times as well on the government course as a tire graded 100. The relative performance of tires depends upon the actual conditions of their use, however, and may depart significantly from the norm due to variations in driving habits, service practices, and differences in road characteristics and climate.

# Wheel and Tire Information

## Traction AA A B C



**WARNING:** The traction grade assigned to this tire is based on straight-ahead braking traction tests, and does not include acceleration, cornering, hydroplaning or peak traction characteristics.

The traction grades, from highest to lowest are AA, A, B, and C. The grades represent the tire's ability to stop on wet pavement as measured under controlled conditions on specified government test surfaces of asphalt and concrete. A tire marked C may have poor traction performance.

## Temperature A B C



**WARNING:** The temperature grade for this tire is established for a tire that is properly inflated and not overloaded. Excessive speed, underinflation, or excessive loading, either separately or in combination, can cause heat buildup and possible tire failure.

The temperature grades are A (the highest), B and C, representing the tire's resistance to the generation of heat and its ability to dissipate heat when tested under controlled conditions on a specified indoor laboratory

test wheel. Sustained high temperature can cause the material of the tire to degenerate and reduce tire life, and excessive temperature can lead to sudden tire failure. The grade C corresponds to a level of performance which all passenger car tires must meet under the Federal Motor Vehicle Safety Standard No. 139. Grades B and A represent higher levels of performance on the laboratory test wheel than the minimum required by law.

## INFORMATION ON THE TIRE SIDEWALL

Both United States and Canada Federal regulations require tire manufacturers to place standardized information on the sidewall of all tires. This information identifies and describes the fundamental characteristics of the tire and also provides a U.S. DOT Tire Identification Number for safety standard certification and in case of a recall.

# Wheel and Tire Information

## Information on P Type Tires

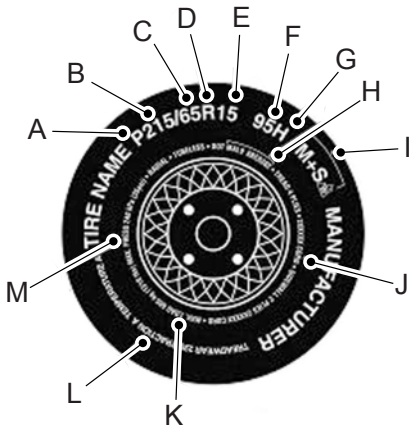

P215/65R15 95H is an example of a tire size, load index and speed rating. The definitions of these items are listed below. (Note that the tire size, load index and speed rating for your vehicle may be different from this example.)

A. **P:** Indicates a tire, designated by the Tire and Rim Association, that may be used for service on cars, sport utility vehicles, minivans and light trucks. **Note:** If your tire size does not begin with a letter this may mean it is designated by either the European Tire and Rim Technical Organization or the Japan Tire Manufacturing Association.

B. **215:** Indicates the nominal width of the tire in millimeters from sidewall edge to sidewall edge. In general, the larger the number, the wider the tire.

C. **65:** Indicates the aspect ratio which gives the tire's ratio of height to width.

D. **R:** Indicates a radial type tire.

E. **15:** Indicates the wheel or rim diameter in inches. If you change your wheel size, you will have to purchase new tires to match the new wheel diameter.

F. **95:** Indicates the tire's load index. It is an index that relates to how much weight a tire can carry. You may find this information in your owner's manual. If not, contact a local tire dealer.

**Note:** You may not find this information on all tires because it is not required by federal law.

G. **H:** Indicates the tire's speed rating. The speed rating denotes the speed at which a tire is designed to be driven for extended periods of time under a standard condition of load and inflation pressure. The tires on your vehicle may operate at different conditions for load and inflation pressure. These speed ratings may need to be adjusted for the difference in conditions. The ratings range from 81 mph (130 km/h) to 186 mph (299 km/h). These ratings are listed in the following chart.



## Wheel and Tire Information

**Note:** You may not find this information on all tires because it is not required by federal law.

Letter rating	Speed rating
M	81 mph (130 km/h)
N	87 mph (140 km/h)
Q	99 mph (159 km/h)
R	106 mph (171 km/h)
S	112 mph (180 km/h)
T	118 mph (190 km/h)
U	124 mph (200 km/h)
H	130 mph (210 km/h)
V	149 mph (240 km/h)
W	168 mph (270 km/h)
Y	186 mph (299 km/h)

**Note:** For tires with a maximum speed capability over 149 mph (240 km/h), tire manufacturers sometimes use the letters ZR. For those with a maximum speed capability over 186 mph (299 km/h), tire manufacturers always use the letters ZR.

**H. U.S. DOT Tire Identification Number (TIN):** This begins with the letters DOT and indicates that the tire meets all federal standards. The next two numbers or letters are the plant code designating where it was manufactured, the next two are

the tire size code and the last four numbers represent the week and year the tire was built. For example, the numbers 317 mean the 31st week of 1997. After 2000, the numbers go to four digits. For example, 2501 means the 25th week of 2001. The numbers in between are identification codes used for traceability. This information is used to contact customers if a tire defect requires a recall.

**I. M+S or M/S:** Mud and Snow, or

**AT:** All Terrain, or

**AS:** All Season.

**J. Tire Ply Composition and Material Used:** Indicates the number of plies or the number of layers of rubber-coated fabric in the tire tread and sidewall. Tire manufacturers also must indicate the ply materials in the tire and the sidewall, which include steel, nylon, polyester, and others.

**K. Maximum Load:** Indicates the maximum load in kilograms and pounds that can be carried by the tire. See the Safety Compliance Certification Label (affixed to either the door hinge pillar, door-latch post, or the door edge that meets the door-latch post, next to the driver's seating position), for the correct tire pressure for your vehicle.

**L. Treadwear, Traction and Temperature Grades:**

## Wheel and Tire Information

**\*Treadwear:** The treadwear grade is a comparative rating based on the wear rate of the tire when tested under controlled conditions on a specified government test course. For example, a tire graded 150 would wear one and one-half times as well on the government course as a tire graded 100.

**\*Traction:** The traction grades, from highest to lowest are AA, A, B, and C. The grades represent the tire's ability to stop on wet pavement as measured under controlled conditions on specified government test surfaces of asphalt and concrete. A tire marked C may have poor traction performance.

**\*Temperature:** The temperature grades are A (the highest), B and C, representing the tire's resistance to the generation of heat and its ability to dissipate heat when tested under controlled conditions on a specified indoor laboratory test wheel.

### M. Maximum Inflation

**Pressure:** Indicates the tire manufacturers' maximum permissible pressure or the pressure at which the maximum load can be carried by the tire. This pressure is normally higher than the vehicle manufacturer's recommended cold inflation pressure which can be found on the Safety Compliance Certification Label (affixed to either the door hinge pillar,

door-latch post, or the door edge that meets the door-latch post, next to the driver's seating position), or Tire Label which is located on the B-Pillar or the edge of the driver's door. The cold inflation pressure should never be set lower than the recommended pressure on the vehicle label.

The tire suppliers may have additional markings, notes or warnings such as standard load or radial tubeless.

### Additional Information Contained on the Tire Sidewall for LT Type Tires

**Note:** *Tire Quality Grades do not apply to this type of tire.*

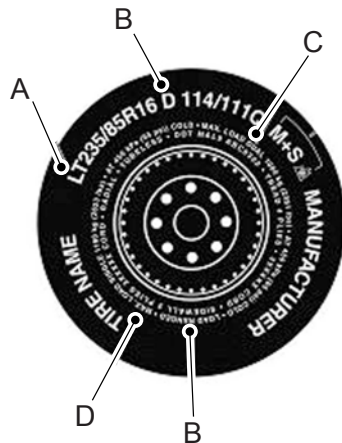

## Wheel and Tire Information

LT type tires have some additional information beyond those of P type tires; these differences are described below.

A. **LT:** Indicates a tire, designated by the Tire and Rim Association, that is intended for service on light trucks.

B. **Load Range and Load Inflation Limits:** Indicates the tire's load-carrying capabilities and its inflation limits.

C. **Maximum Load Dual lb (kg) at psi (kPa) cold:** Indicates the maximum load and tire pressure when the tire is used as a dual, defined as four tires on the rear axle (a total of six or more tires on the vehicle).

D. **Maximum Load Single lb (kg) at psi (kPa) cold:** Indicates the maximum load and tire pressure when the tire is used as a single, defined as two tires (total) on the rear axle.

### Information on T Type Tires

T145/80D16 is an example of a tire size.

**Note:** *The temporary tire size for your vehicle may be different from this example. Tire Quality Grades do not apply to this type of tire.*

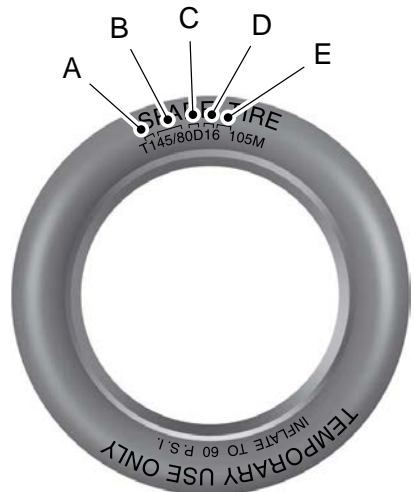

T type tires have some additional information beyond those of P type tires; these differences are described below:

A. **T:** Indicates a type of tire, designated by the Tire and Rim Association, that is intended for temporary service on cars, sport utility vehicles, minivans and light trucks.

B. **145:** Indicates the nominal width of the tire in millimeters from sidewall edge to sidewall edge. In general, the larger the number, the wider the tire.

# Wheel and Tire Information

---

C. **80:** Indicates the aspect ratio which gives the tire's ratio of height to width. Numbers of 70 or lower indicate a short sidewall.

D. **D:** Indicates a diagonal type tire.

**R:** Indicates a radial type tire.

E. **16:** Indicates the wheel or rim diameter in inches. If you change your wheel size, you will have to purchase new tires to match the new wheel diameter.

## GLOSSARY OF TIRE TERMINOLOGY

\***Tire label:** A label showing the original equipment tire sizes, recommended inflation pressure and the maximum weight the vehicle can carry.

\***Tire Identification Number (TIN):** A number on the sidewall of each tire providing information about the tire brand and manufacturing plant, tire size and date of manufacture. Also referred to as DOT code.

\***Inflation pressure:** A measure of the amount of air in a tire.

\***Standard load:** A class of P-metric or Metric tires designed to carry a maximum load at set pressure. For example: For P-metric tires 35 psi (2.4 bar) and for Metric tires 36 psi (2.5 bar). Increasing the inflation pressure beyond this pressure will not increase the tire's load carrying capability.

\***Extra load:** A class of P-metric or Metric tires designed to carry a heavier maximum load at 42 psi (2.9 bar). Increasing the inflation pressure beyond this pressure will not increase the tire's load carrying capability.

\***kPa:** Kilopascal, a metric unit of air pressure.

\***PSI:** Pounds per square inch, a standard unit of air pressure.

\***Cold tire pressure:** The tire pressure when the vehicle has been stationary and out of direct sunlight for an hour or more and prior to the vehicle being driven for 1 mi (1.6 km).

\***Recommended inflation pressure:** The cold inflation pressure found on the Safety Compliance Certification Label (affixed to either the door hinge pillar, door-latch post, or the door edge that meets the door-latch post, next to the driver's seating position), or Tire Label located on the B-Pillar or the edge of the driver door.

\***B-pillar:** The structural member at the side of the vehicle behind the front door.

\***Bead area of the tire:** Area of the tire next to the rim.

\***Sidewall of the tire:** Area between the bead area and the tread.

# Wheel and Tire Information

**\*Tread area of the tire:** Area of the perimeter of the tire that contacts the road when mounted on the vehicle.

**\*Rim:** The metal support (wheel) for a tire or a tire and tube assembly upon which the tire beads are seated.

## TIRE REPLACEMENT REQUIREMENTS

### AGE



**WARNING:** Tires degrade over time depending on many factors such as weather, storage conditions, and conditions of use (load, speed, inflation pressure) the tires experience throughout their lives.

In general, tires should be replaced after six years regardless of tread wear. However, heat caused by hot climates or frequent high loading conditions can accelerate the aging process and may require tires to be replaced more frequently.

You should replace your spare tire when you replace the road tires or after six years due to aging even if it has not been used.

## U.S. DOT Tire Identification Number

Both United States and Canada Federal regulations require tire manufacturers to place standardized information on the sidewall of all tires. This information identifies and describes the fundamental characteristics of the tire and also provides a U.S. DOT Tire Identification Number for safety standard certification and in case of a recall.

This begins with the letters DOT and indicates that the tire meets all federal standards. The next two numbers or letters are the plant code designating where it was manufactured, the next two are the tire size code and the last four numbers represent the week and year the tire was built. For example, the numbers 317 mean the 31st week of 1997. After 2000, the numbers go to four digits. For example, 2501 means the 25th week of 2001. The numbers in between are identification codes used for traceability. This information is used to contact customers if a tire defect requires a recall.

## Tire Replacement Requirements

Your vehicle is equipped with tires designed to provide a safe ride and handling capability.

## Wheel and Tire Information



**WARNING:** Only use replacement tires and wheels that are the same size, load index, speed rating, and type as those originally provided for your vehicle. The recommended tire and wheel sizes can be found on the Tire Label on the driver side door frame or the edge of the driver door. If this information is not found in those locations, or for additional options, contact your authorized dealer. Use of any tire or wheel not recommended, could affect the safety and performance of your vehicle, which could result in an increased risk of loss of vehicle control, vehicle rollover, personal injury and death.



**WARNING:** Replace the wheels and tires with the exact original brand, size and construction that came originally on your vehicle. Use of any other wheel or tire combinations, even with identical size ratings, may result in insufficient running clearances, tire rubbing and eventual puncture. Failure to follow tire replacement recommendations can lead to tire failure, loss of vehicle control, serious injury or death.



**WARNING:** To reduce the risk of serious injury, when mounting replacement tires and wheels, you should not exceed the maximum pressure indicated on the sidewall of the tire to set the beads without additional precautions listed below. If the beads do not seat at the maximum pressure indicated, re-lubricate and try again.



**WARNING:** For a mounting pressure more than 20 psi (1.38 bar) greater than the maximum pressure, a Ford dealer or other tire service professional should do the mounting.



**WARNING:** Always inflate steel carcass tires with a remote air fill with the person inflating standing at a minimum of 12 ft (3.66 m) away from the wheel and tire assembly.



**WARNING:** When inflating the tire for mounting pressures up to 20 psi (1.38 bar) greater than the maximum pressure on the tire sidewall, the following precautions must be taken to protect the person mounting the tire:

- Make sure that you have the correct tire and wheel size.
- Lubricate the tire bead and wheel bead seat area again.

# Wheel and Tire Information

- Stand at a minimum of 12 ft (3.66 m) away from the wheel and tire assembly.
- Use both eye and ear protection.

**Important:** Remember to replace the wheel valve stems when the road tires are replaced on your vehicle.

It is recommended that the two front tires or two rear tires generally be replaced as a pair if the worn tires still have usable depth.

To avoid potential Four-Wheel Drive (4WD) malfunction or (4WD) system damage, it is recommended to replace all four tires rather than mixing significantly worn tires with new tires.

The tire pressure sensors mounted in the wheels (originally installed on your vehicle) are not designed to be used in aftermarket wheels.

The use of wheels or tires not recommended may affect the operation of your tire pressure monitoring system.

If the tire pressure monitoring system indicator is flashing, your system is malfunctioning. Your replacement tire might be incompatible with your tire pressure monitoring system, or some component of the system may be damaged.

## USING SNOW CHAINS



**WARNING:** Do not exceed 30 mph (50 km/h). Failure to follow this instruction could result in the loss of control of your vehicle, personal injury or death.



**WARNING:** Do not use snow chains on snow-free roads.



**WARNING:** Only fit snow chains to specified tires.



**WARNING:** If your vehicle is fitted with wheel trims, remove them before fitting snow chains.



**WARNING:** If you choose to install snow tires on your vehicle, they must be the same size, construction, and load range as the original tires listed on the tire placard, and they must be installed on all four wheels. Mixing tires of different size or construction on your vehicle can adversely affect your vehicle's handling and braking, and may lead to loss of vehicle control.



**WARNING:** Wheels and tires must be the same size, load index and speed rating as those originally fitted on the vehicle. Use of any other tire or wheel can affect the safety and performance of your vehicle. Additionally, the use of non-recommended tires and wheels can cause steering, suspension, axle, transfer case or power transfer unit failure. Follow the recommended tire inflation pressures found on the Safety Compliance Certification label, or the Tire Label on the B-Pillar or the edge of the driver door. Failure to follow this instruction could result in loss of vehicle control, vehicle rollover, or personal injury or death.

## Wheel and Tire Information

Only use snow chains on the rear wheels. Install snow chains in pairs. Do not use self-tensioning snow chains.

Only use snow chains on 275/65R18 tire size. Only install chains that are 15mm or less (SAE Class S chains).

We recommend you use steel wheels of the same size and specification if snow chains are required because chains may chip aluminum wheels.

Follow these guidelines when using snow tires and traction devices:

- If possible, avoid fully loading your vehicle.
- Purchase snow chains from a manufacturer that clearly labels body to tire dimension restrictions.
- When driving with snow chains do not exceed 30 mph (50 km/h) or the maximum speed recommended by the chain manufacturer, whichever is less.
- Drive cautiously. If you hear the snow chains rub or bang against the vehicle, stop and tighten them. If this does not work, remove the snow chains to prevent vehicle damage.
- Remove the snow chains when they are no longer needed. Do not use snow chains on dry roads.
- If a temporary spare wheel is mounted on your vehicle, do not use snow chains on the axle with the temporary spare wheel.

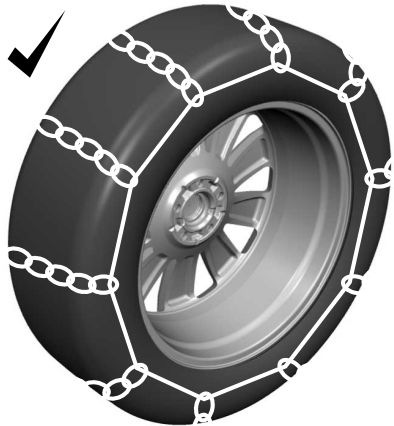
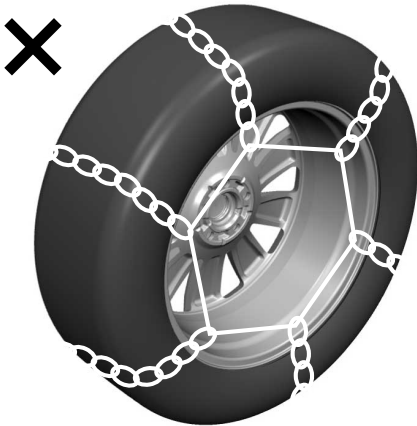

Use snow chains that fit against the sidewall of the tire to prevent the chains from touching the wheel rims or suspension. Refer to the previous illustration.

If you have any questions regarding snow chains, please contact your authorized dealer.



# Tire Care

## CHECKING THE TIRE PRESSURES

Safe operation of your vehicle requires that your tires are properly inflated. Every day before you drive, check your tires.

At least once a month and before long trips, inspect each tire and check the tire pressure with a tire gauge. Inflate all tires to the recommended inflation pressure. See **Inflating the Tires** (page 461).

## INFLATING THE TIRES



**WARNING:** Under-inflation is the most common cause of tire failures and may result in severe tire cracking, tread separation or blowout, with unexpected loss of vehicle control and increased risk of injury. Under-inflation increases sidewall flexing and rolling resistance, resulting in heat buildup and internal damage to the tire. It also may result in unnecessary tire stress, irregular wear, loss of vehicle control and accidents. A tire can lose up to half of its air pressure and not appear to be flat!



**WARNING:** Do not use the tire pressure displayed in the information display as a tire pressure gauge. Failure to follow this instruction could result in personal injury or death.

Use the recommended cold inflation pressure for optimum tire performance and wear. Under-inflation or over-inflation may cause uneven treadwear patterns.

Inflate your tires to the recommended inflation pressure even if it is less than the maximum inflation pressure information found on the tire. You can find the tire label with the recommended tire inflation pressure next to the tire size on the B-Pillar or the edge of the driver door.

The recommended tire inflation pressure is also found on the Safety Compliance Certification Label, affixed to either the door hinge pillar, door-latch post, or the door edge that meets the door-latch on the B-pillar, or on the edge of the driver door.

Failure to follow the tire pressure recommendations can cause uneven treadwear patterns and adversely affect the way your vehicle handles.

# Tire Care

## INSPECTING THE TIRE FOR WEAR

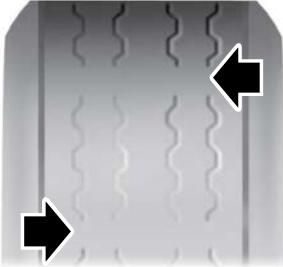

When the tread is worn down to one sixteenth of an inch (2 mm), tires must be replaced to help prevent your vehicle from skidding and hydroplaning. Built-in treadwear indicators, or wear bars, which look like narrow strips of smooth rubber across the tread will appear on the tire when the tread is worn down to one sixteenth of an inch (2 mm).

When the tire tread wears down to the same height as these wear bars, the tire is worn out and must be replaced.

The tires should also be balanced periodically. An unbalanced tire and wheel assembly may result in irregular tire wear.

Periodically inspect the tire treads for uneven or excessive wear and remove objects such as stones, nails or glass that may be wedged in the tread grooves.

## INSPECTING THE TIRE FOR DAMAGE

Inspect the tire sidewalls for cracking, cuts, bruises and other signs of damage or excessive wear. If internal damage to the tire is suspected, have the tire dismantled and inspected in case it needs to be repaired or replaced. For your safety, tires that are damaged or show signs of excessive wear should not be used because they are more likely to blow out or fail.

Periodically inspect the tire treads and sidewalls for damage, such as bulges in the tread or sidewalls, cracks in the tread groove and separation in the tread or sidewall. If damage is observed or suspected, have the tire inspected by a tire professional.

## Safety Practices



**WARNING:** If your vehicle is stuck in snow, mud or sand, do not rapidly spin the tires; spinning the tires can tear the tire and cause an explosion. A tire can explode in as little as three to five seconds.



**WARNING:** Do not spin the wheels at over 34 mph (55 km/h). The tires may fail and injure a passenger or bystander.

# Tire Care

## Highway Hazards

No matter how carefully you drive, there is always the possibility that you could eventually have a flat tire on the highway. Drive slowly to the closest safe area out of traffic. This could further damage the flat tire, but your safety is more important.

If you feel a sudden vibration or ride disturbance while driving, or you suspect your tire or vehicle has been damaged, immediately reduce your speed. Drive with caution until you can safely pull off the road. Stop and inspect the tires for damage. If a tire is under-inflated or damaged, deflate it, remove the wheel and replace it with your spare tire and wheel. If you cannot detect a cause, have the vehicle towed to the nearest repair facility or tire dealer to have the vehicle inspected.

## Tire and Wheel Alignment

A bad jolt from hitting a curb or pothole can cause the front end of your vehicle to become misaligned or cause damage to your tires. If your vehicle seems to pull to one side when you are driving, the wheels could be out of alignment. Have an authorized dealer check the wheel alignment periodically.

Wheel misalignment in the front or the rear can cause uneven and rapid treadwear of your tires and should be corrected by an authorized dealer.

## INSPECTING THE WHEEL VALVE STEMS

Check the valve stems for holes, cracks, or cuts that could permit air leakage.

## TIRE ROTATION



**WARNING:** If the tire label shows different tire pressures for the front and rear tires and the vehicle has a tire pressure monitoring system, then you need to update the settings for the system sensors. Always perform the system reset procedure after tire rotation. If you do not reset the system, it may not provide a low tire pressure warning when necessary.

Rotating your tires at the recommended interval will help your tires wear more evenly, providing better tire performance and longer tire life.

**Note:** *If your tires show any uneven wear have the alignment checked by an authorized dealer before rotating tires.*

# Tire Care

---

**Note:** *If you have a dissimilar spare wheel and tire assembly, it is intended for temporary use only and should not be used in a tire rotation.*

**Note:** *After having your tires rotated, inflation pressure must be checked and adjusted to the vehicle requirements.*

## Tire Rotation Diagram

Follow the diagram indicating the correct tire locations for rotating the tires.

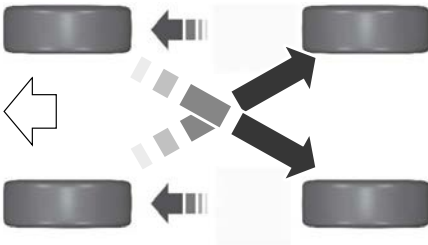

# Tire Pressure Monitoring System

## WHAT IS THE TIRE PRESSURE MONITORING SYSTEM



The tire pressure monitoring system measures the vehicle's tire pressures. A warning lamp illuminates if one or more tires are significantly underinflated or if there is a system malfunction.

## TIRE PRESSURE MONITORING SYSTEM OVERVIEW



**WARNING:** If the tire pressure monitor sensor becomes damaged it may not function.



**WARNING:** Under-inflation is the most common cause of tire failures and may result in severe tire cracking, tread separation or blowout, with unexpected loss of vehicle control and increased risk of injury. Under-inflation increases sidewall flexing and rolling resistance, resulting in heat buildup and internal damage to the tire. It also may result in unnecessary tire stress, irregular wear, loss of vehicle control and accidents. A tire can lose up to half of its air pressure and not appear to be flat!



**WARNING:** To determine the required pressure(s) for your vehicle, see the Safety Compliance Certification Label (on the door hinge pillar, door-latch post or the door edge that meets the door-latch post, next to the driver seat) or the Tire Label on the B-Pillar or the edge of the driver door.

Each tire, including the spare (if provided), should be checked monthly when cold and inflated to the inflation pressure recommended by the vehicle manufacturer on the vehicle placard or tire inflation pressure label. (If your vehicle has tires of a different size than the size indicated on the vehicle placard or tire inflation pressure label, you should determine the proper tire inflation pressure for those tires).

As an added safety feature, your vehicle has been equipped with a Tire Pressure Monitoring System (TPMS) that illuminates a low tire pressure telltale when one or more of your tires is significantly under-inflated. Accordingly, when the low tire pressure telltale illuminates, you should stop and check your tires as soon as possible, and inflate them to the proper pressure. Driving on a significantly under-inflated tire causes the tire to overheat and can lead to tire failure. Under-inflation also reduces fuel efficiency and tire tread life, and may affect the vehicle's handling and stopping ability.

Please note that the TPMS is not a substitute for proper tire maintenance, and it is the driver's responsibility to maintain correct tire pressure, even if under-inflation has not reached the level to trigger illumination of the TPMS low tire pressure telltale.

Your vehicle has also been equipped with a TPMS malfunction indicator to indicate when the system is not operating properly. The TPMS malfunction indicator is combined with the low tire pressure telltale. When the system detects a malfunction, the telltale will flash for approximately one minute and then remain continuously illuminated. This sequence will continue upon subsequent vehicle start-ups as long as the malfunction exists.

# Tire Pressure Monitoring System

When the malfunction indicator is illuminated, the system may not be able to detect or signal low tire pressure as intended. TPMS malfunctions may occur for a variety of reasons, including the installation of replacement or alternate tires or wheels on the vehicle that prevent the TPMS from functioning properly. Always check the TPMS malfunction telltale after replacing one or more tires or wheels on your vehicle to ensure that the replacement or alternate tires and wheels allow the TPMS to continue to function properly.



**WARNING:** Changes or modifications not expressly approved by the party responsible for compliance could void the user's authority to operate the equipment. The term "IC:" before the radio certification number only signifies that Industry Canada technical specifications were met.

This device complies with Part 15 of the FCC Rules and with License exempt RSS Standards of Industry Canada. Operation is subject to the following two conditions:

1. This device may not cause harmful interference, and
2. This device must accept any interference received, including interference that may cause undesired operation.

## TIRE PRESSURE MONITORING SYSTEM PRECAUTIONS



**WARNING:** The tire pressure monitoring system is not a substitute for manually checking tire pressures. You should periodically check tire pressures using a pressure gauge. Failure to correctly maintain tire pressures could increase the risk of tire failure, loss of control, vehicle rollover and personal injury.



**WARNING:** Do not use the tire pressure displayed in the information display as a tire pressure gauge. Failure to follow this instruction could result in personal injury or death.

**Note:** *The use of tire sealants can damage the tire pressure monitoring system.*

## TIRE PRESSURE MONITORING SYSTEM LIMITATIONS

When the outside temperature drops significantly, the tire pressure could decrease and activate the low tire pressure warning lamp.

The warning lamp could also illuminate when you use a spare wheel, or tire sealant from the inflator kit.

**Note:** *Regularly checking the vehicle tire pressures can reduce the possibility for the warning lamp to illuminate due to outside air temperature changes.*

**Note:** *After you inflate the tires to the recommended pressure it could take up to two minutes of driving over 20 mph (32 km/h) for the warning indicator to turn off.*

# Tire Pressure Monitoring System

## VIEWING THE TIRE PRESSURES



Using the instrument cluster display arrow keys navigate to the truck info section where you can view the tire pressures.

## RESETTING TIRE PRESSURE MONITORING SYSTEM

### Tire Pressure Monitoring System Reset Procedure



**WARNING:** To determine the required pressure(s) for your vehicle, see the Safety Compliance Certification Label (on the door hinge pillar, door-latch post or the door edge that meets the door-latch post, next to the driver seat) or the Tire Label on the B-Pillar or the edge of the driver door.

You must reset the tire pressure monitoring system after each tire rotation on vehicles that require different recommended tire pressures in the front tires as compared to the rear tires.

**Note:** To reduce the chances of interference from another vehicle, perform the system reset procedure at least three feet, one meter, away from another vehicle undergoing the system reset procedure at the same time.

**Note:** Do not wait more than two minutes between resetting each tire sensor or the system can time-out and you need to repeat the entire procedure on all four wheels.

1. Drive the vehicle above 20 mph (32 km/h) for at least two minutes, then park in a safe location where you can easily get to all four tires and have access to an air pump.
2. Switch the ignition off.
3. Switch the ignition on but do not start the engine.
4. Switch the hazard flashers on then off three times.

**Note:** You must accomplish this within 10 seconds. If you successfully enter the reset mode, the horn sounds once, the system indicator flashes and a message shows in the information display.

# Tire Pressure Monitoring System

**Note:** *If the system does not enter reset mode, try again starting at Step 2. If after repeated attempts to enter the reset mode, the horn does not sound, the system indicator does not flash and no message shows in the information display, contact your authorized dealer.*

5. Remove the valve cap from the valve stem on the left front tire. Decrease the air pressure until the horn sounds.

**Note:** *The single horn tone confirms that the sensor identification code has been learned by the module for this position. If the horn sounds twice, the reset procedure was unsuccessful, and you must repeat it.*

6. Remove the valve cap from the valve stem on the right front tire. Decrease the air pressure until the horn sounds.
7. Repeat the previous step on the right rear tire and then on the left rear tire.
8. Switch the ignition off.

**Note:** *If the horn sounds twice again after switching the ignition off, and repeating the procedure, contact your authorized dealer and have your vehicle checked as soon as possible.*

9. Set all four tires to the recommended air pressure as indicated on the Safety Compliance Certification Label.

## Trailer Tire Pressure Monitoring System (If Equipped)

**Note:** *Additional equipment may be required for your vehicle to support trailer tire pressure and temperature monitoring. See your authorized dealer for more information.*

**Note:** *The trailer tire pressure monitoring system is not a substitute for proper tire maintenance. It is your responsibility to maintain correct tire pressures at all times.*

**Note:** *If a trailer tire is repaired, replaced or broken down for service, the screw and valve on the trailer tire pressure sensor should be replaced. See your authorized dealer for details.*



The trailer tire pressure monitoring system is an added safety feature that allows you to view your trailer tire pressures and temperatures through the information display. See **Tire Pressure Monitoring System – Information Messages** (page 471). Tire



# Tire Pressure Monitoring System

---

pressure sensors are mounted into each tire on your trailer. The sensors send a message to your vehicle indicating the current trailer tire pressure and temperature.

If the trailer tire pressure monitoring system detects that a tire is low, a warning message appears in the information display. The trailer tire information screen in the information display highlights the tire with a low pressure.

If the trailer tire pressure monitoring system detects that a tire temperature is over temp, a warning message appears in the Information display. The trailer tire information screen in the information display highlights the tire with a high temperature.

The main function of the trailer tire pressure monitoring system is to warn you when your trailer tires need air or if the tires are experiencing high temperatures. It can also warn you in the event the system is no longer capable of functioning as intended. See

**Tire Pressure Monitoring System – Information Messages** (page 471).

## **When a Temporary Spare or New Tire is Installed**

If you have replaced a trailer tire with a new or spare tire, a warning message appears and pressure readings are no longer displayed for that tire.

To restore the full function of the trailer tire pressure monitoring system:

- Have the damaged wheel and tire assembly repaired and remounted to your trailer.
- Install the trailer tire pressure monitoring sensor into the new wheel and tire assembly.
- Perform the trailer tire pressure monitoring system reset procedure.

## **Trailer Tire Pressure Monitoring System Reset Procedure**

**Note:** *You need to perform the tire pressure monitoring system reset procedure after each tire rotation, or when a new trailer tire pressure sensor is installed into a trailer tire.*

The trailer tire pressure monitoring system can be reset through the menu in the information display. See **Tire Pressure Monitoring System – Information Messages** (page 471). Performing the trailer setup process also resets the trailer tire pressure monitoring system.

# Tire Pressure Monitoring System

## TIRE PRESSURE MONITORING SYSTEM – TROUBLESHOOTING



The low tire pressure warning lamp has combined functions, as it warns you when your tires need air, and when the system is no longer capable of functioning as intended.

## TIRE PRESSURE MONITORING SYSTEM – WARNING LAMPS

Warning Lamp	Possible Cause	Action Required
Solid warning lamp	One or more tires are significantly under inflated	After inflating your tires to the manufacturer's recommended pressure as shown on the tire label, on the edge of driver door or the B-pillar, drive your vehicle for at least two minutes over 20 mph (32 km/h) before the light turns off.
	Tire rotation without sensor training	On vehicles with different front and rear tire pressures, the system must be retrained following every tire rotation.
Solid warning lamp or flashing warning lamp	Temporary spare wheel in use	Repair the damaged road wheel and tire and refit it to your vehicle to restore operation of the system.
	Tire pressure monitoring system malfunction	If the tires are inflated to the recommended tire pressures and the temporary spare wheel is not in use, the system detected a fault that requires service. Have your vehicle checked as soon as possible.

# Tire Pressure Monitoring System

## TIRE PRESSURE MONITORING SYSTEM – INFORMATION MESSAGES

Message	Action
Tire Pressure Low	After inflating your tires to the manufacturer's recommended pressure as shown on the Tire Label, on the edge of the driver door or the B-Pillar, drive your vehicle for at least two minutes over 20 mph (32 km/h) before the light turns off.
Tire Pressure Monitor Fault	The system has detected a fault that requires service. Have your vehicle checked as soon as possible.
Tire Pressure Sensor Fault	The system has detected a fault that requires service or a spare tire is in use. Have your vehicle checked as soon as possible.

## Trailer Tire Pressure Monitoring System

Message	Action
Trailer Tire Low Specified:	One or more tires on your trailer is below the specified tire pressure.
Trailer Tire Over Temperature	Displays when one or more tires on your trailer is above the recommended temperature.
Trailer Tire Pressure Sensor Fault	A trailer tire pressure sensor is malfunctioning. If the warning stays on or continues to come on, contact an authorized dealer as soon as possible.
Trailer Tire Pressure Monitor Fault	The trailer tire pressure monitoring system is malfunctioning. If the warning stays on or continues to come on, contact an authorized dealer.
Trailer Tire Pressure Monitor Capability Not Detected	The system cannot detect the trailer tire pressure monitoring system.
Trailer Tire Pressure Indication Not Setup See Manual	The trailer tire pressure monitoring system is not setup. See <b>Tire Pressure Monitoring System</b> (page 465).

# Changing a Road Wheel

## CHANGING A FLAT TIRE

**Note:** *The use of tire sealant may damage your tire pressure monitoring system and should only be used in roadside emergencies.*

**Note:** *The tire pressure monitoring system indicator light illuminates when the spare tire is in use. To restore the full function of the monitoring system, all road wheels equipped with tire pressure monitoring sensors must be mounted on this vehicle.*

If you get a flat tire when driving, do not apply the brake heavily. Instead, gradually decrease your speed. Hold the steering wheel firmly and slowly move to a safe place on the side of the road.

Have a flat serviced by an authorized dealer to prevent damage to the system sensors. See **Tire Pressure Monitoring System Precautions** (page 466). Replace the spare tire with a road tire as soon as possible. During repairing or replacing the flat tire, have the authorized dealer inspect the system sensor for damage.

## Dissimilar Spare Wheel and Tire Assembly Information



**WARNING:** Failure to follow these guidelines could result in an increased risk of loss of vehicle control, injury or death.

If you have a dissimilar spare wheel and tire, then it is intended for temporary use only. This means that if you need to use it, you should replace it as soon as possible with a road wheel and tire assembly that is the same size and type as the road tires and wheels that were originally provided by Ford.

A dissimilar spare wheel and tire assembly is defined as a spare wheel and tire assembly that is different in brand, size or appearance from the road tires and wheels.

### Full-size dissimilar spare

When driving with the full-size dissimilar spare wheel and tire assembly, do not:

- Exceed 70 mph (113 km/h).
- Use more than one dissimilar spare wheel and tire assembly at a time.
- Use snow chains on the end of the vehicle with the dissimilar spare wheel and tire assembly.
- Repair a damaged dissimilar spare tire. Replace a dissimilar spare tire that is damaged.
- Drive extended distances with a dissimilar spare. Tread life is limited to approximately 2,000 mi (3,219 km).
- Use commercial car wash equipment.

When driving with the full-size dissimilar spare wheel and tire assembly, four-wheel drive functionality could be limited.

When driving with the full-size dissimilar spare wheel and tire assembly, it is recommended that you do not:

- Exceed 50 mph (80 km/h) in four-wheel drive.
- Engage four-wheel drive unless the vehicle is stationary.
- Use four-wheel drive on dry pavement.

Using a full-size dissimilar spare wheel and tire assembly can lead to impairment of the following:

- Handling, stability and braking performance.
- Comfort and noise.
- Ground clearance and parking at curbs.
- Winter weather driving capability.

# Changing a Road Wheel

- Wet weather driving capability.
- Four-wheel drive capability.

When driving with the full-size dissimilar spare wheel and tire assembly additional caution should be given to:

- Towing a trailer.
- Driving vehicles equipped with a camper body.
- Driving vehicles with a load on the cargo rack.

Drive cautiously when using a full-size dissimilar spare wheel and tire assembly and seek service as soon as possible.

## Tire Change Procedure

 **WARNING:** To help prevent your vehicle from moving when changing a wheel, shift the transmission into park (P), set the parking brake and use an appropriate block or wheel chock to secure the wheel diagonally opposite to the wheel being changed. For example, when changing the front left wheel, place an appropriate block or wheel chock on the right rear wheel.

 **WARNING:** The jack supplied with this vehicle is only intended for changing a flat tire in an emergency. Do not attempt to do any other work on your vehicle when it is supported by the jack, as your vehicle could slip off the jack. Failure to follow this instruction could result in personal injury or death.

 **WARNING:** Do not attempt to change a tire on the side of the vehicle close to moving traffic. Pull far enough off the road to not obstruct the flow of traffic and avoid the danger of being hit when operating the jack or changing the wheel.

 **WARNING:** Only use the jack provided as original equipment with your vehicle.

 **WARNING:** The jack should be used on level firm ground wherever possible.

 **WARNING:** Never place anything between the vehicle jack and the ground.

 **WARNING:** Never place anything between the vehicle jack and your vehicle.

 **WARNING:** It is recommended that the wheels of the vehicle be chocked, and that no person should remain in a vehicle that is being jacked.

 **WARNING:** Switch off the running boards before jacking or placing any object under your vehicle. Never place your hand between the extended running board and your vehicle. A moving running board may cause injury.

 **WARNING:** Always fully apply the parking brake. Failure to follow this instruction could result in personal injury or death.

 **WARNING:** No person should place any portion of their body under a vehicle that is supported by a jack.

 **WARNING:** Only use the specified jacking points. If you use any other locations you could damage vehicle components, such as brake lines.

**Note:** *Only use the spare tire carrier to stow the tire and wheel combination provided with your vehicle. Other tire and wheel combinations can cause the tire carrier to fail.*

# Changing a Road Wheel

**Note:** Do not use impact tools or power tools operating at over 200 RPM on the spare tire carrier, this could cause a winch malfunction and prevent a secure fit.

**Note:** Passengers should not remain in the vehicle when the vehicle is being jacked.

Park on a level surface, activate the hazard flashers and set the parking brake. Then, place the transmission in park (P) and power the vehicle off.

## Removing the Vehicle Jack and Tool Bag

The vehicle jack and tool bag are behind the rear passenger side seat.

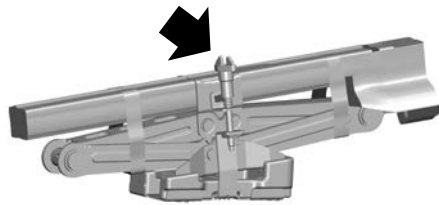

1. Turn the wing bolt on the jack bracket counterclockwise to release the jack and tool bag from the jack bracket.

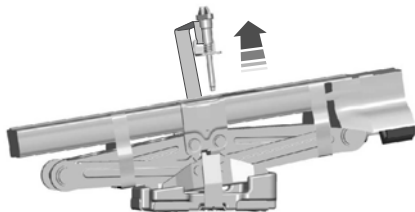

2. Remove the jack and tool bag from the jack bracket.

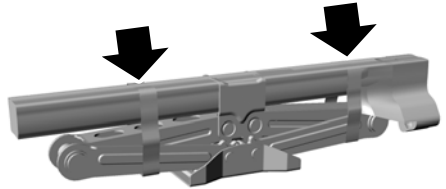

3. Release the jack tool bag straps.

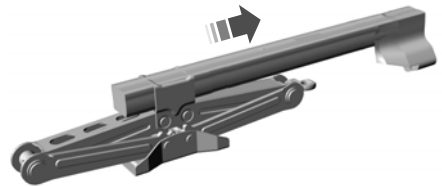

4. Slide the jack tool bag through the jack load rest to remove for access to the jack tools.
5. Remove the tools from the tool bag.

**Note:** Your jack does not require maintenance or additional lubrication over the service life of your vehicle.

## Removing the Spare Tire

**Note:** Remove the hook end from the assembled jack handle before continuing.

The spare tire is located under the vehicle, just forward of the rear bumper.

# Changing a Road Wheel

1. Use your key to remove the lock cylinder from the access hole of the bumper to allow access to the guide tube.

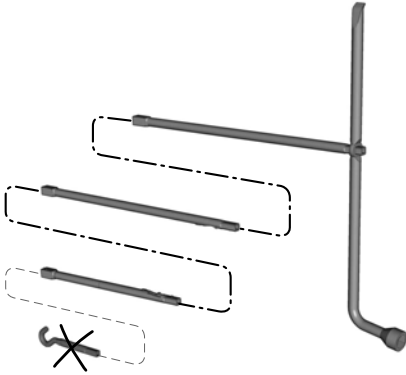

2. Assemble the jack handle as shown in the illustration.
3. Fully insert the jack handle through the bumper hole and into the guide tube through the access hole in the rear bumper. Turn the handle counterclockwise until the tire is lowered to the ground and the cable is slightly slack to allow the tire to be slid rearward from under the vehicle.

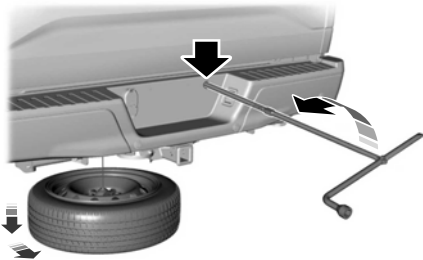

4. Lift the spare tire on end to access the tether attachment



5. Use the lug wrench to remove the lug nut from the spare tire tether.
6. Remove the retainer from the center of the wheel.

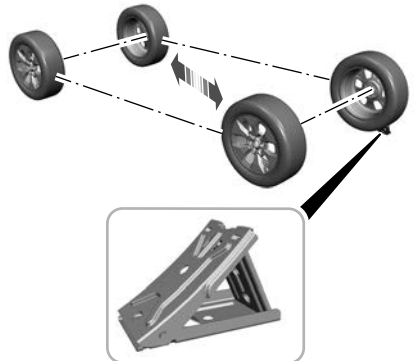

7. Unfold the wheel chock provided in the tool kit and use it to block the rear edge of the tire diagonally opposite the flat tire. For example, if the left front tire is flat, block the right rear of the right rear tire.
8. Obtain the spare tire and vehicle jack from their storage locations.

# Changing a Road Wheel

9. Loosen each wheel nut on the affected flat tire one-half turn counterclockwise, but do not remove them.

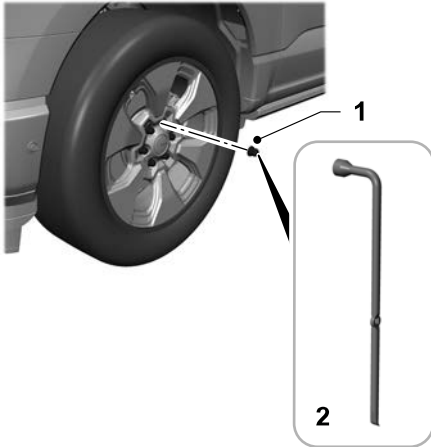

- 1 Wheel nut.
- 2 Lug wrench.

## Jacking the Vehicle

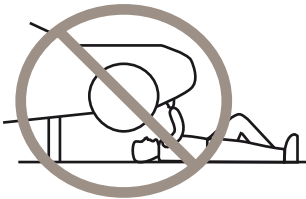

## Front Jacking Points

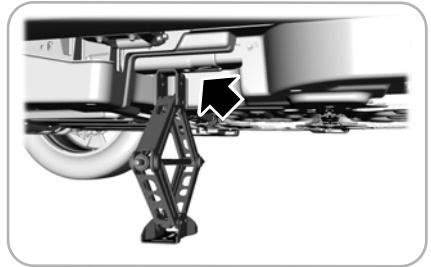

**Note:** Use the frame rail as the front jacking location point, not the control arm. The frame rail is marked with an arrow.

## Rear Jacking Points

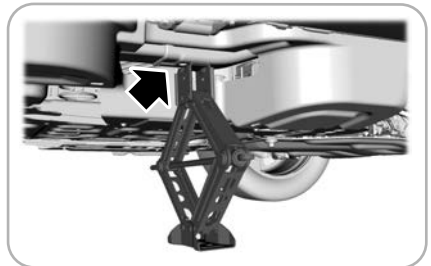

**Note:** Jack at the specified locations to avoid damage to the vehicle.



# Changing a Road Wheel

1. Place the vehicle jack at the jacking point next to the tire you are changing.
2. Reassemble the jack handle, including the S-hook, to the lug wrench. Insert the S-hook into the eyelet of the jack and turn the jack handle clockwise until the wheel is completely off the ground.
3. Remove the wheel nuts with the lug wrench.
4. Replace the flat tire with the spare tire, making sure the valve stem is facing outward. Reinstall the wheel nuts until the wheel is snug against the hub. Do not fully tighten the wheel nuts until the wheel has been lowered.
5. Lower the wheel by turning the jack handle counterclockwise.
6. Remove the vehicle jack and fully tighten the wheel nuts in the order shown.
7. Stow the flat tire. See the Stowing the Flat or Spare Tire.
8. Stow the vehicle jack and lug wrench. Make sure the jack is securely fastened before you drive. See Stowing the Vehicle Jack and Tool Bag.
9. Unblock the wheels.

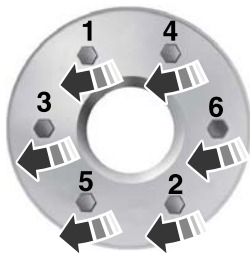

## Stowing the Flat or Spare Tire

**Note:** Failure to follow the spare tire stowage instructions could result in failure of the cable or loss of the spare tire.

1. Lay the tire on the ground with the valve stem facing up.
2. Slide the wheel partially under the vehicle and install the retainer through the wheel center. Pull on the cable to align the components at the end of the cable.
3. Turn the jack handle clockwise until the tire is raised to its stowed position underneath the vehicle. The effort to turn the jack handle increases significantly and the spare tire carrier ratchets or slips when the tire is raised to the maximum tightness. Tighten to the point where the ratchet or slip occurs a minimum of three times, as indicated by an audible click each time. The spare tire carrier does not allow you to overtighten. If the spare tire carrier ratchets or slips with little effort, contact your authorized dealer.
4. Check that the tire lies flat against the frame and is properly tightened. Try to push or pull, then turn the tire to be sure it does not move. Loosen and retighten, if necessary. Failure to properly stow the spare tire could result in failure of the winch cable and loss of the tire.
5. Repeat this tightness check procedure when servicing the spare tire pressure, every six months, as per your scheduled maintenance information, or at any time that the spare tire is disturbed through service of other components.
6. If removed, install the spare tire lock into the bumper drive tube with the spare tire lock key and jack handle.

# Changing a Road Wheel

## Stowing the Vehicle Jack and Tool Bag

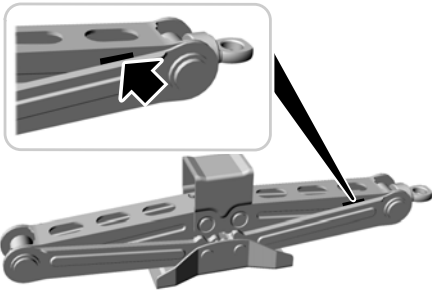

1. Turn the lead screw eyelet to adjust the jack up or down until the stowage markings on the upper channel align with the lower channel.

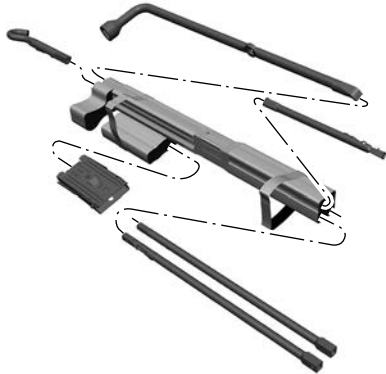

2. Replace the tools and wheel chock inside of the tool bag.

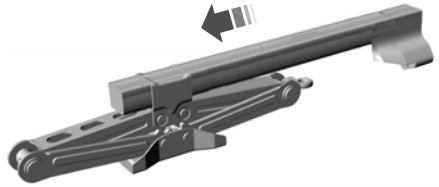

3. Install the tool bag through the vehicle jack load rest.

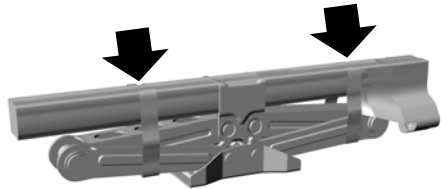

4. Secure the jack tool bag straps around the vehicle jack.

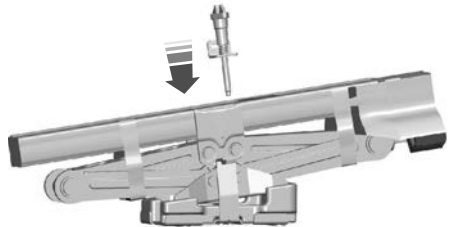

5. Place the jack and tool bag back onto the jack bracket.

# Changing a Road Wheel

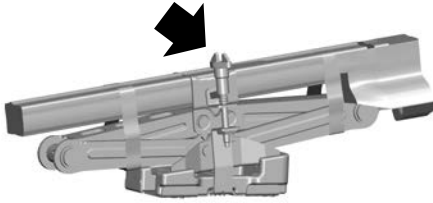

6. Turn the wing bolt on the jack bracket clockwise until the jack and tools are secured to the jack bracket.

## WHEEL NUTS



**WARNING:** When you install a wheel, always remove any corrosion, dirt or foreign materials present on the mounting surfaces of the wheel or the surface of the wheel hub, brake drum or brake disc that contacts the wheel. Make sure to secure any fasteners that attach the rotor to the hub so they do not interfere with the mounting surfaces of the wheel. Installing wheels without correct metal-to-metal contact at the wheel mounting surfaces can cause the wheel nuts to loosen and the wheel to come off while your vehicle is in motion, resulting in loss of vehicle control, personal injury or death.

Bolt Size	lb.ft (Nm) <sup>1</sup>
M14 x 1.5	150 lb.ft (204 Nm)

<sup>1</sup> Torque specifications are for nut and bolt threads free of dirt and rust. Use only our recommended replacement wheel nuts and or wheel bolts.

Retighten the wheel nuts to the specified torque within 100 mi (160 km) after any wheel disturbance, such as tire rotation, changing a flat tire or wheel removal.



A Hub pilot bore.

Inspect the wheel pilot hole and mounting surface prior to installation. Remove any visible corrosion or loose particles.

# Capacities and Specifications

## MOTORCRAFT PARTS

Component	Motorcraft Part Number
12 volt battery.	BHAGM-H3
Cabin air filter.	FP-92
Windshield wiper blade.	WW-2208 (driver side) WW-2208 (passenger side)

We recommend Motorcraft parts that are available at your authorized dealer or at [www.fordparts.com](http://www.fordparts.com). We engineer these parts for your vehicle to meet or exceed our specifications. Use of other parts could impact vehicle performance and durability. Your warranty could be void for any damage related to use of other parts.

## COOLING SYSTEM CAPACITY AND SPECIFICATION

Use coolant that meets the defined specification.

If you do not use coolant that meets the defined specification, it could result in:

- Component damage that your vehicle warranty does not cover.
- Reduced vehicle performance.
- Reduced range.

## Cooling System

### Capacities

Variant	Quantity
Standard battery, single power inverter.	15.3 qt (14.5 L)
Extended Range battery, dual power inverter.	16.3 qt (15.4 L)
Standard battery, single power inverter.	16.8 qt (15.9 L)
Extended Range battery, dual power inverter.	17.8 qt (16.8 L)

# Capacities and Specifications

## Materials

Name	Specification
Motorcraft® Yellow Prediluted Antifreeze/ Coolant (U.S.) Motorcraft® Yellow Prediluted Antifreeze/Coolant / Antigel/liquide de refroidissement prédilué jaune Motorcraft® (Canada) VC-13DL-G (U.S.) CVC-13DL-G (Canada)	WSS-M97B57-A2

## AIR CONDITIONING SYSTEM CAPACITY AND SPECIFICATION



**WARNING:** The air conditioning refrigerant system contains refrigerant under high pressure. Only qualified personnel should service the air conditioning refrigerant system. Opening the air conditioning refrigerant system can cause personal injury.

Use refrigerant and oil that meets the defined specifications.

If you do not use refrigerant and oil that meets the defined specifications, it could result in:

- Component damage that your vehicle warranty does not cover.
- Reduced vehicle performance.
- Reduced range.

## Capacities

Variant	Refrigerant	Refrigerant Oil
Base	27 oz (0.765 kg)	6.1 fl oz (180 ml)
Max Trailer Tow	21.5 oz (0.61 kg)	6.1 fl oz (180 ml)
Battery Cooling System	11 oz (0.312 kg)	4.7 fl oz (140 ml)

# Capacities and Specifications

## Materials

Name	Specification
R-1234yf Refrigerant(U.S.) R-1234yf Refrigerant / Frigorigène R-1234yf(Canada) YN-33-A(U.S.) HS7Z-19B519-BA(Canada)	WSS-M17B21-A
Motorcraft® R-1234yf Refrigerant POE Oil(U.S.) Motorcraft® R-1234yf Refrigerant POE Oil / Huile POE pour frigorigène R-1234yf Motorcraft®(Canada) YN-34(U.S. & Canada)	WSS-M2C31-B2

## WASHER FLUID SPECIFICATION

### Capacities

Variant	Quantity
All.	Fill as required.

## Materials

Name	Specification
Motorcraft® Premium Windshield Wash Concentrate with Bitterant(U.S.) Motorcraft® Premium Quality Windshield Washer Fluid / Liquide lave-glacé de haute qualité Motorcraft®(Canada) ZC-32-B2(U.S.) CXC-37-F/M(Canada)	WSS-M14P19-A

## BRAKE FLUID SPECIFICATION

Use fluid that meets the defined specification and viscosity grade.

If you do not use fluid that meets the defined specification and viscosity grade, it could result in:

- Component damage that your vehicle warranty does not cover.
- Reduced brake performance.

# Capacities and Specifications

---

**Note:** We recommend you use Dot 4 Low Viscosity (LV) High Performance Brake Fluid meeting WSS-M6C65-A2 specifications or ISO 4925 Class 6 standards. If you use any fluid other than the recommended fluid, it could cause reduced brake performance and not meet our performance standards. Keep brake fluid clean and dry. Contamination with dirt, water, petroleum products or other materials could result in brake system damage and possible failure.

## Capacities

Variant	Quantity
All.	Fill as required.

## Materials

Name	Specification
Motorcraft® DOT 4 LV High Performance Motor Vehicle Brake Fluid(U.S.) Motorcraft® DOT 4 LV High Performance Motor Vehicle Brake Fluid / Liquide de frein automobile haute performance DOT 4 LV Motorcraft®(Canada) PM-20(U.S. & Canada)	WSS-M6C65-A2





# Connected Vehicle

---

## WHAT IS A CONNECTED VEHICLE

A connected vehicle has technology that allows your vehicle to connect to a mobile network and for you to access a range of features. When used in conjunction with the FordPass app, it could allow you to monitor and control your vehicle further, for example checking the tire pressures, and the vehicle location. For additional information, refer to the local Ford website.

## CONNECTED VEHICLE REQUIREMENTS

Connected service and related feature functionality requires a compatible vehicle network.

Some remote features require additional service activation. Log in to your Ford account for details. Some restrictions, third party terms and message or data rates may apply.

## CONNECTED VEHICLE LIMITATIONS

Evolving technology, cellular networks, or regulations could affect functionality and availability, or continued provision of some features. These changes could even stop some features from functioning.

## CONNECTING THE VEHICLE TO A MOBILE NETWORK

### WHAT IS THE MODEM



The modem allows access to a range of features built into your vehicle.

## ENABLING AND DISABLING THE MODEM - VEHICLES WITH: 12.3 INCH SCREEN

1. Press **Settings**.
2. Press **Connectivity**.
3. Press **Connected Vehicle Features**.
4. Switch vehicle connectivity on or off.

## ENABLING AND DISABLING THE MODEM - VEHICLES WITH: 15 INCH SCREEN

Tap the vehicle drawer on the top left of the screen.

1. Press **Connectivity**.
2. Press **Connected Vehicle Features**.
3. Switch vehicle connectivity on or off.

## CONNECTING FORDPASS TO THE MODEM

1. Make sure that the modem is enabled using the vehicle settings menu.
2. Open the FordPass app on your device and log in.
3. Add your vehicle or select your vehicle if already added.
4. Select the option to activate your vehicle.
5. Make sure that the name on the screen matches the name shown in your FordPass account.
6. Confirm that FordPass account is connected to the modem.

# Connected Vehicle

---

## CONNECTING THE VEHICLE TO A WI-FI NETWORK - VEHICLES WITH: 12.3 INCH SCREEN



Select the settings option on the feature bar.

1. Press **Connectivity**.
2. Press **Manage Wi-Fi Networks**.
3. Switch **Wi-Fi** on.
4. Press **View Available Networks**.
5. Select an available Wi-Fi network.

**Note:** Enter the network password to connect to a secure network.

## CONNECTING THE VEHICLE TO A WI-FI NETWORK - VEHICLES WITH: 15 INCH SCREEN

Access the application drawer on the touchscreen.

1. Press **Connectivity**.
2. Press **Manage Wi-Fi Networks**.
3. Switch **Wi-Fi** on.
4. Press **View Available Networks**.
5. Select an available Wi-Fi network.

**Note:** Enter the network password to connect to a secure network.

## CONNECTED VEHICLE – TROUBLESHOOTING

### CONNECTED VEHICLE – FREQUENTLY ASKED QUESTIONS - VEHICLES WITH: MODEM

#### Why can I not confirm the connection of my FordPass account to the modem?

- The modem is not enabled. Switch vehicle connectivity on.
- The network signal is weak. Move your vehicle closer to a place where the network signal is not obstructed.

### CONNECTED VEHICLE – FREQUENTLY ASKED QUESTIONS - VEHICLES WITH: SYNC 4

#### Why can I not confirm the connection of my FordPass account to the modem?

- The modem is not enabled. Switch vehicle connectivity on.
- The network signal is weak. Move your vehicle closer to a place where the network signal is not obstructed.

# Connected Vehicle

---

## **Why can I not connect to a Wi-Fi network?**

- You entered the wrong network password. Enter the correct password.
- The network signal is weak. Move your vehicle closer to the Wi-Fi router or to a place where the network signal is not obstructed.
- There are multiple access points in range with the same network name. Choose a unique name for your network. Do not use the default name unless it contains a unique identifier, for example as part of the MAC address.

## **Why does the Wi-Fi connection disconnect after successful connection?**

- The network signal is weak. Move your vehicle closer to the Wi-Fi router or to a place where the network signal is not obstructed.

## **What can I do if I am close to a Wi-Fi router but the network signal strength is weak?**

- If your vehicle has a heated windshield, position your vehicle so that the windshield is not facing the Wi-Fi router.
- If your vehicle has metallic tinting on the windows but not on the windshield, position your vehicle so that the windshield is facing the Wi-Fi router or open the windows that are facing the router.
- If your vehicle has metallic tinting on the windows and the windshield, open the windows that are facing the router.
- If your vehicle is in a garage and you have the garage door closed, open the garage door as it could block the signal.

## **Why can I not see a network I expect to see in the list of available networks?**

- The network is hidden. Make the network visible and try again, or manually add a network in the Wi-Fi settings menu.
- Some network security types are not supported, for example WEP.

## **Why do software downloads take too long?**

- The network signal is weak. Move your vehicle closer to the Wi-Fi router or to a place where the network signal is not obstructed.
- Wi-Fi network is in high demand or has a slow Internet connection. Use a more reliable Wi-Fi network.

## **Why does the software not update when the system seems to connect to a Wi-Fi network and the signal strength is excellent?**

- No software update is available at this time.
- Select automatic updates option in the settings menu to enable automatic software update or contact an authorized dealer.
- There could be a connection problem. Test the network using another device.

# Vehicle Wi-Fi Hotspot - Vehicles With: 12.3 Inch Screen

## CREATING A VEHICLE WI-FI HOTSPOT

You can create a Wi-Fi hotspot in your vehicle and allow devices to connect to it for access to the Internet.



Select the settings option on the feature bar.

1. Press **Vehicle Hotspot**.

**Note:** The vehicle hotspot default setting is on.

2. Press **Settings**.
3. Press **Edit**.
4. Press **Hotspot visibility**.

**Note:** The hotspot visibility default setting is on.

## Finding the Wi-Fi Hotspot Name and Password



Select the settings option on the feature bar.

1. Press **Vehicle Hotspot**.
2. Press **Settings**.

**Note:** The network name is the hotspot name.

3. Press **View Password**.

## Connecting a Device to the Wi-Fi Hotspot

1. On your device, switch Wi-Fi on and select the hotspot from the list of available Wi-Fi networks.
2. When prompted, enter the password.

## Purchasing a Data Plan

1. Connect a device to the hotspot.

**Note:** The vehicle network carrier's portal opens on your device.

2. If the portal does not open on your device, open a website and it redirects to the vehicle network carrier's portal.

**Note:** Secure websites do not redirect.

3. Follow the instructions on the carrier portal to purchase a plan.

**Note:** If you have an active plan, the system does not redirect to the vehicle network carrier's portal when you connect a device. Visit the vehicle network carrier's website to purchase more data.

**Note:** If data usage information is available in the vehicle hotspot menu, it is approximate.

**Note:** If you carry out a master reset, the system does not remove your vehicle from your vehicle network carrier's account. To remove your vehicle from the account, contact your vehicle network carrier.

**Note:** The vehicle network carrier provides Vehicle Hotspot services, subject to your vehicle network carrier agreement, coverage and availability.

## CHANGING THE VEHICLE WI-FI HOTSPOT NAME OR PASSWORD



Select the settings option on the feature bar.

1. Press **Vehicle Hotspot**.
2. Press **Settings**.
3. Press **Edit**.
4. Press **Change Network Name**.
5. Enter your required network name.
6. Press **Done**.
7. Press **Change Password**.
8. Enter your required password.
9. Press **Done**.

# Vehicle Wi-Fi Hotspot - Vehicles With: 12.3 Inch Screen

---

## Changing the Wi-Fi Hotspot Frequency

**Note:** *The vehicle hotspot frequency band is selectable depending upon your device capabilities. You will not be able to connect your device to the vehicle hotspot if it does not support the selected frequency band.*



Select the settings option on the feature bar.

1. Press **Vehicle Hotspot**.
2. Press **Settings**.
3. Press **Edit**.
4. Select a frequency.

## VEHICLE WI-FI HOTSPOT – TROUBLESHOOTING

### VEHICLE WI-FI HOTSPOT – FREQUENTLY ASKED QUESTIONS

#### **Why can I not see the Wi-Fi hotspot name when I search for Wi-Fi networks on my cell phone or other device?**

- Make sure Wi-Fi hotspot visibility is on.
- The system does not provide a Wi-Fi hotspot at this time.
- Check what frequency the hotspot is transmitting in the vehicle hotspot settings menu. If the frequency is 5 GHz and your device cannot see the network, change the frequency to 2.4 GHz.

## Vehicle Wi-Fi Hotspot - Vehicles With: 15 Inch Screen

### CREATING A VEHICLE WI-FI HOTSPOT

You can create a Wi-Fi hotspot in your vehicle and allow devices to connect to it for access to the Internet.

Tap the vehicle drawer on the top left of the screen.

1. Press **Vehicle Hotspot**.

**Note:** The vehicle hotspot default setting is on.

2. Press Settings under the Vehicle Hotspot menu.
3. Press **Edit**.
4. Switch the Wi-Fi Visibility option on or off.

**Note:** The Wi-Fi visibility default setting is on.

### Finding the Wi-Fi Hotspot Name and Password

Tap the vehicle drawer on the top left of the screen.

1. Press **Vehicle Hotspot**.
2. Press Settings under the Vehicle Hotspot menu.

**Note:** The network name is the hotspot name.

3. Switch the Show Password option on or off.

### Connecting a Device to the Wi-Fi Hotspot

1. On your device, switch Wi-Fi on and select the hotspot from the list of available Wi-Fi networks.
2. When prompted, enter the password.

### Purchasing a Data Plan

1. Connect a device to the hotspot.

**Note:** The vehicle network carrier's portal opens on your device.

2. If the portal does not open on your device, open a website and it redirects to the vehicle network carrier's portal.

**Note:** Secure websites do not redirect.

3. Follow the instructions on the carrier portal to purchase a plan.

**Note:** If you have an active plan, the system does not redirect to the vehicle network carrier's portal when you connect a device. Visit the vehicle network carrier's website to purchase more data.

**Note:** If data usage information is available in the vehicle hotspot menu, it is approximate.

**Note:** If you carry out a master reset, the system does not remove your vehicle from your vehicle network carrier's account. To remove your vehicle from the account, contact your vehicle network carrier.

**Note:** The vehicle network carrier provides Vehicle Hotspot services, subject to your vehicle network carrier agreement, coverage and availability.

### CHANGING THE VEHICLE WI-FI HOTSPOT NAME OR PASSWORD

Tap the vehicle drawer on the top left of the screen.

1. Press **Vehicle Hotspot**.
2. Press Settings under the Vehicle Hotspot menu.
3. Press **Edit**.
4. Press **Change Network Name**.
5. Enter your required network name.
6. Press enter to save the network name.
7. Press **Change Password**.
8. Enter your required password.

# Vehicle Wi-Fi Hotspot - Vehicles With: 15 Inch Screen

---

9. Press enter to save the password.

## Changing the Wi-Fi Hotspot Frequency

**Note:** *The vehicle hotspot frequency band is selectable depending upon your device capabilities. You will not be able to connect your device to the vehicle hotspot if it does not support the selected frequency band.*

Tap the vehicle drawer on the top left of the screen.

1. Press **Vehicle Hotspot**.
2. Press Settings under the Vehicle Hotspot menu.
3. Press **Edit**.
4. Select a frequency.

## VEHICLE WI-FI HOTSPOT – TROUBLESHOOTING

### VEHICLE WI-FI HOTSPOT – FREQUENTLY ASKED QUESTIONS

#### **Why can I not see the Wi-Fi hotspot name when I search for Wi-Fi networks on my cell phone or other device?**

- Make sure Wi-Fi hotspot visibility is on.
- The system does not provide a Wi-Fi hotspot at this time.
- Check what frequency the hotspot is transmitting in the vehicle hotspot settings menu. If the frequency is 5 GHz and your device cannot see the network, change the frequency to 2.4 GHz.

# Audio System - Vehicles With: 12.3 Inch Screen

## AUDIO SYSTEM PRECAUTIONS



**WARNING:** Driving while distracted can result in loss of vehicle control, crash and injury. We strongly recommend that you use extreme caution when using any device that may take your focus off the road. Your primary responsibility is the safe operation of your vehicle. We recommend against the use of any hand-held device while driving and encourage the use of voice-operated systems when possible. Make sure you are aware of all applicable local laws that may affect the use of electronic devices while driving.

Listening to loud audio for long periods of time could damage your hearing.

## IDENTIFYING THE AUDIO UNIT



Depending on your vehicle options, the controls may look different from what you see here.

## SWITCHING THE AUDIO UNIT ON AND OFF



Press the button on the volume control.

## SELECTING THE AUDIO SOURCE

### Audio Unit



Press to open the media source menu.

You can press this multiple times to change the audio source or scroll through the media sources.

### Touchscreen

Press **Sources** on the touchscreen to open the media source menu.

## PLAYING OR PAUSING THE AUDIO SOURCE

### Audio Unit



Press the button to pause playback. Press again to resume playback.

### Touchscreen



Press the button to pause playback. Press again to resume playback.

**Note:** *Not all sources can be paused.*



# Audio System - Vehicles With: 12.3 Inch Screen

## ADJUSTING THE VOLUME

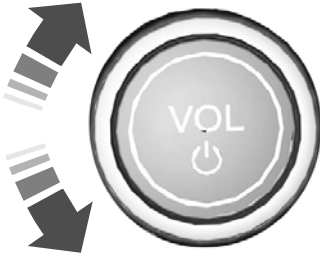

Turn to adjust the volume.

Some vehicles may be able to adjust the volume using buttons on the steering wheel.

## SWITCHING SHUFFLE MODE ON AND OFF



Press the button on the touchscreen to switch shuffle mode on or off.

**Note:** *Not all sources have shuffle mode.*

## SWITCHING REPEAT MODE ON AND OFF



Press the button on the touchscreen to switch repeat mode on or off.

**Note:** *Not all sources have repeat mode.*

## SETTING A MEMORY PRESET

1. Select a station or channel.
2. Press and hold a memory preset button on the touchscreen.

**Note:** *The audio mutes briefly while the system saves the preset and returns once it is stored.*

**Note:** *You can save presets from multiple sources to the memory preset bar.*

## MUTING THE AUDIO



Press to mute the signal. Press again to restore the signal.

## ADJUSTING THE SOUND SETTINGS

### Balance and Fade (if Equipped)

1. Press **Settings** on the touchscreen.
2. Press **Sound Settings**.
3. Press **Balance / Fade**.
4. Press the arrows to adjust the settings.

### Tone Settings

1. Press **Settings** on the touchscreen.
2. Press **Sound Settings**.
3. Press **Tone Settings**.
4. Press the arrows or slider bar to adjust the settings.

### Speed Compensated Volume

1. Press **Settings** on the touchscreen.
2. Press **Sound Settings**.
3. Press **Speed Compensated Volume**.
4. Press a setting.

# Audio System - Vehicles With: 12.3 Inch Screen

## Occupancy Mode (If Equipped)

1. Press **Settings** on the touchscreen.
2. Press **Sound Settings**.
3. Press **Occupancy Mode**.
4. Press a setting.

## Sound Mode (If Equipped)

1. Press **Settings** on the touchscreen.
2. Press **Sound Settings**.
3. Press **Sound Mode**.
4. Press a setting.

## SETTING THE CLOCK AND DATE

1. Press **Settings** on the touchscreen.
2. Press **Clock Settings**.
3. Set the time.

**Note:** The **AM** and **PM** options are not available if **24-hour mode** is on.

## Switching Automatic Time Updates On and Off

1. Press **Settings** on the touchscreen.
2. Press **Clock Settings**.
3. Switch **Auto Time Update** on or off.

## AM/FM RADIO

### AM/FM RADIO LIMITATIONS

The further you travel from an AM or FM station, the weaker the signal and the weaker the reception.

Hills, mountains, tall buildings, bridges, tunnels, freeway overpasses, parking garages, dense tree foliage and thunderstorms can interfere with the reception.

When you pass a ground-based broadcast repeating tower, a stronger signal may overtake a weaker one and result in the audio system muting.

## SELECTING A RADIO STATION

### Manually Selecting a Radio Station

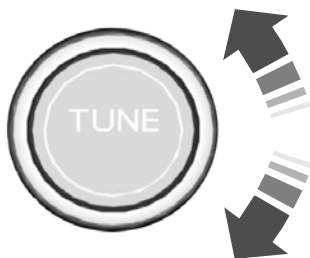

Turn to search through the radio frequency band.

### Using Direct Tune

1. Press **Direct Tune** to open the number pad.
2. Enter the station you prefer.

**Note:** You can only enter a valid station for the audio source you are currently listening to.

### Using Seek

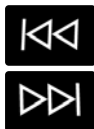

Press either button. The system stops at the first station it finds in that direction.

# Audio System - Vehicles With: 12.3 Inch Screen

## Using the Station List

1. Press **Browse**.

**Note:** Available on FM radio only.

2. Press a station.

## SWITCHING THE DISPLAY ON AND OFF

### Audio Unit



Press the button.

### Touchscreen

To switch the display off:

1. Press **Settings** on the touchscreen.
2. Press **Display Settings**.
3. Press **Display Off**.

**Note:** The display defaults to on each time you switch your vehicle on.

To switch the display on, press anywhere on the touchscreen.

## DIGITAL RADIO (IF EQUIPPED)

### WHAT IS DIGITAL RADIO

HD Radio™ technology is the digital evolution of analog AM/FM radio.

For additional information, visit [www.HDRadio.com](http://www.HDRadio.com).

HD Radio Technology is manufactured under license from iBiquity Digital Corporation and foreign patents. HD Radio and the HD and HD Radio logos are proprietary trademarks of DTS. The vehicle manufacturer and DTS are not responsible for the content sent using HD Radio technology. Content may be changed, added or deleted at any time at the station owner's discretion.

### HOW DOES DIGITAL RADIO WORK

Your system has a special receiver that allows it to receive digital broadcasts in addition to analog broadcasts.

HD1 signifies the main programming status and is available in both analog and digital broadcasts. Other multicast stations are only available digitally and could contain new or different content.

**Note:** When the system first receives an HD1 station, it plays the station in the analog version until it verifies the station is an HD Radio station. Then it shifts to the digital version.

**Note:** There is an audio mute delay when switching to an HD2 or HD3 station because the system has to reacquire and decode the digital signal.

### DIGITAL RADIO LIMITATIONS

If you are outside the reception area, the system could not work.

If you are on the fringe of the reception area, the station could mute due to weak signal strength.

**Note:** If you are listening to HD1, the system changes back to the analog broadcast until the digital broadcast is available again. If you are listening to any other multicast channels, the station mutes and stays muted unless it is able to connect to the digital signal again.

## Audio System - Vehicles With: 12.3 Inch Screen

Depending on the station quality, you could hear a slight sound change when the station changes between analog and digital audio.

You cannot access a saved HD station if your vehicle is outside the station's reception area.

### SWITCHING DIGITAL RADIO RECEPTION ON AND OFF

1. Press **Settings** on the touchscreen.
2. Press **Radio Settings**.
3. Switch **AM HD Radio** or **FM HD Radio** on or off.

### DIGITAL RADIO INDICATORS

#### HD Radio Indicator

The indicator appears when HD Radio is on and you tune to a station broadcasting HD Radio technology.



The color of the indicator changes to indicate the system status.

Gray indicates the system is acquiring a digital station.

Orange indicates digital audio is playing.

#### Multicast Indicator

The multicast indicator appears if the current station is broadcasting multiple digital broadcasts. The highlighted numbers indicate additional digital channels available.

**Note:** For stations that have more than one HD multicast, the HD indicator and radio text appears as a button. Press the button to cycle through all of the HD stations on that specific frequency.

### SATELLITE RADIO (IF EQUIPPED)

#### WHAT IS SATELLITE RADIO

Your factory-installed SiriusXM radio system includes a limited subscription term, which begins on the date of sale or lease of your vehicle. See an authorized dealer for availability.

For additional information about extended subscription terms, visit [www.SiriusXM.com](http://www.SiriusXM.com) in the United States, [www.SiriusXM.ca](http://www.SiriusXM.ca) in Canada, or call SiriusXM at 1-888-539-7474.

**Note:** SiriusXM reserves the unrestricted right to change, rearrange, add or delete programming including canceling, moving or adding particular channels, and its prices, at any time, with or without notice to you. Neither SiriusXM and its affiliates nor Ford Motor Company and its affiliates will be liable to you or any third party for any such modification, suspension or termination.

#### SATELLITE RADIO LIMITATIONS

For optimal reception performance, keep the antenna clear of snow and ice build-up and keep luggage and other material as far away from the antenna as possible. Placing luggage over the antenna may reduce performance. Factory-installed and aftermarket vehicle structures including, but not limited to, roof racks and soft top roofs in a partially open position could reduce reception performance.

# Audio System - Vehicles With: 12.3 Inch Screen

Hills, mountains, tall buildings, bridges, tunnels, freeway overpasses, parking garages, dense tree foliage and thunderstorms can interfere with your reception.

When you pass a ground-based broadcast-repeating tower, a stronger signal may overtake a weaker one and could result in the audio system muting. Your display could show an error message to indicate the interference.

## LOCATING THE SATELLITE RADIO IDENTIFICATION NUMBER

1. Select SiriusXM as the audio source.
2. Tune to channel 0.

## SELECTING A CHANNEL

### Manually Selecting a Channel

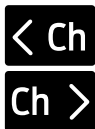

Press the button to find the previous or next available radio channel.

### Linear Tuner

The linear tuner is displayed when manually selecting a channel. You can swipe left or right on the linear tuner carousel to navigate through the channel list. Tap on a channel title to listen to it.

### Using Direct Tune

1. Press the channel up or down button to open the linear tuner screen.
2. Press **Direct Tune** to open the number pad.
3. Enter the channel you prefer.

### Using Browse

1. Press **Browse**.

2. Select a channel.

## SATELLITE RADIO SETTINGS

### Subscription

Your subscription status is displayed. You can subscribe or manage your subscription directly from the touchscreen.

### Listener Add/Switch

You can create up to five listener profiles per SiriusXM account. Each listener profile can be personalized with a name and profile image.

**Note:** *Requires a trial or active subscription to use.*

**Note:** *A default profile is available when no listener profiles are created.*

### SiriusXM Favorites

SiriusXM Favorites are shown for the active listener profile. While you are listening to SiriusXM, you can save favorites by:

- Tapping the currently tuned channel or show logo on the SiriusXM audio screen. A favorite icon appears next to the logo when it is saved as a favorite.
- Tuning to a channel or show you want to save as a favorite. Navigate to the SiriusXM Favorites screen and press the Add Current button. The currently tuned channel or show is saved as a favorite.
- Saving a radio preset. This saves the currently tuned SiriusXM channel or show as a favorite.

**Note:** *Requires a trial or active subscription to use.*

# Audio System - Vehicles With: 12.3 Inch Screen

---

## Listening History

Listening history is a list of recently listened to SiriusXM content and is shown for the active listener profile. You can view, manage and reset the listening history using the controls on the touchscreen.

**Note:** Requires a trial or active subscription to use.

## Listener Settings

Listener settings apply to the active listener profile.

**Note:** Requires a trial or active subscription to use.

**Note:** A default profile is available when no listener profiles are created.

## Help and Support

You can contact SiriusXM Customer Care directly from SYNC and view information required to manage your SiriusXM account.

# Audio System - Vehicles With: 12.3 Inch Screen

## AUDIO SYSTEM – TROUBLESHOOTING

### AUDIO SYSTEM – INFORMATION MESSAGES

#### Satellite Radio Troubleshooting

Error Message	Potential Effects	Recommended Action
Connectivity Disabled	Internet streaming and On Demand shows are unavailable and some SiriusXM features are disabled.	Internet connectivity is turned off. See <b>Connected Vehicle</b> (page 485).
No Internet	Audio system may mute. Switch to Satellite button may be displayed on the SiriusXM audio screen if the channel is also available via satellite.	SYNC attempts to connect. See <b>Satellite Radio Limitations</b> (page 507). Switch to a satellite connection for the current channel if the option is available.
No Satellite Signal	Audio system may mute. Switch to Internet button may be displayed on the SiriusXM audio screen if the channel is also available via streaming.	Antenna may be obstructed or satellite reception is weak in your location. See <b>Satellite Radio Limitations</b> (page 507). Switch to an internet connection for the current channel if the option is available.
Slow Network Connection	Audio system may mute while the audio attempts to load.	Allow some time for the audio to load or tune to a different channel.
Channel Unavailable	Audio system may mute. Radio may tune to a different channel.	A temporary update may be in progress. Allow some time before retrying to tune to the channel. If the issue continues, the channel may no longer be available.
Episode Unavailable	Audio system may mute. Radio may tune to a different channel.	A temporary update may be in progress. Allow some time before retrying to play the episode. If the issue continues, the episode may no longer be available.

## Audio System - Vehicles With: 12.3 Inch Screen

Error Message	Potential Effects	Recommended Action
Something went wrong	Audio system may mute. Radio may tune to a different channel.	Allow some time and retry the action.
Subscribe to Listen	Cannot listen to selected content. Content may appear grayed out and some features may be disabled.	<p>Your subscription has expired or you have not yet subscribed for access to the listed content. Navigate to Subscription under the Satellite Radio Settings menu. If you have an active subscription which includes the listed channel or content and you see this error, you may need to refresh your radio. To refresh your SiriusXM radio, visit <a href="http://www.siriusxm.com/refresh">www.siriusxm.com/refresh</a> in the US, or <a href="http://www.siriusxm.ca/refresh">www.siriusxm.ca/refresh</a> in Canada.</p> <p>You may need to provide your SiriusXM Radio identification number. See <b>Locating the Satellite Radio Identification Number</b> (page 497).</p>



## Audio System - Vehicles With: 12.3 Inch Screen

Error Message	Potential Effects	Recommended Action
Upgrade to Listen	Cannot listen to selected content. Content may appear grayed out and some features may be disabled.	<p>Your subscription does not include access to the listed content. You may need to upgrade your subscription. Navigate to Subscription under the Satellite Radio Settings menu. If you have an active subscription which includes the listed channel or content and you see this error, you may need to refresh your radio. To refresh your SiriusXM radio, visit <a href="http://www.siriusxm.com/refresh">www.siriusxm.com/refresh</a> in the US, or <a href="http://www.siri-usxm.ca/refresh">www.siri-usxm.ca/refresh</a> in Canada. You may need to provide your SiriusXM Radio identification number. See <b>Locating the Satellite Radio Identification Number</b> (page 497).</p>
Location Restricted Content	Audio may mute. Not available in your location or Unable to determine your location may be displayed.	Content is not available in your location or SiriusXM is unable to determine your location. Tuning to a different channel may resolve the issue.
Channel Blocked	Audio may mute. Radio may tune to a different channel.	<p>The Block Explicit Content filter is turned on. Navigate to Listener Settings under the Satellite Radio Settings menu to access the Block Explicit Content filter. Navigate to Listener Settings. See <b>Satellite Radio Settings</b> (page 507).</p>
Antenna Problem or Hardware Problem	Audio may mute. Access to SiriusXM features may be unavailable.	If issue persists, you may need to visit an authorized dealer for service.

## Audio System - Vehicles With: 12.3 Inch Screen

---

<b>Error Message</b>	<b>Potential Effects</b>	<b>Recommended Action</b>
SiriusXM Updating...	Audio may mute.	Allow SiriusXM some time to complete updating.
Loading...	Audio may mute. Content may be temporarily unavailable while loading.	No action necessary. If loading time is longer than usual, See <b>Satellite Radio Settings</b> (page 507).
SiriusXM Loading...	Audio may mute. Content and controls may be temporarily unavailable.	No action necessary. Allow SiriusXM some time to finish loading.

# Audio System - Vehicles With: 15 Inch Screen

## AUDIO SYSTEM PRECAUTIONS



**WARNING:** Driving while distracted can result in loss of vehicle control, crash and injury. We strongly recommend that you use extreme caution when using any device that may take your focus off the road. Your primary responsibility is the safe operation of your vehicle. We recommend against the use of any hand-held device while driving and encourage the use of voice-operated systems when possible. Make sure you are aware of all applicable local laws that may affect the use of electronic devices while driving.

Listening to loud audio for long periods of time could damage your hearing.

## SWITCHING THE AUDIO UNIT ON AND OFF



Press the button on the volume control.

## SELECTING THE AUDIO SOURCE

1. Press your preferred audio source.

**Note:** Available audio sources are listed along the top of the radio screen.

## PLAYING OR PAUSING THE AUDIO SOURCE



Press to pause playback. Press again to resume playback.

**Note:** Not all sources can be paused.

## ADJUSTING THE VOLUME

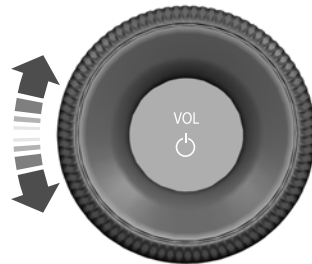

Turn to adjust the volume.

You can also press the mute button on the map screen.

Some vehicles may be able to adjust the volume using buttons on the steering wheel.

## SWITCHING SHUFFLE MODE ON AND OFF



Press the button on the touchscreen to switch shuffle mode on or off.

**Note:** Not all sources have shuffle mode.

## SWITCHING REPEAT MODE ON AND OFF



Press the button on the touchscreen to switch repeat mode on or off.

**Note:** Not all sources have repeat mode.

## SETTING A MEMORY PRESET

1. Select a station or channel.
2. Press and hold a memory preset button on the touchscreen.

# Audio System - Vehicles With: 15 Inch Screen

**Note:** The audio mutes briefly while the system saves the preset and returns once it is stored.

**Note:** You can save presets from multiple sources to the memory preset bar.

## MUTING THE AUDIO



Press to mute the signal. Press again to restore the signal.

## ADJUSTING THE SOUND SETTINGS

### Balance and Fade (If Equipped)

1. Access the vehicle drawer on the touchscreen.
2. Press **SETTINGS**.
3. Press **Sound**.
4. Press **Balance / Fade**.
5. Press the arrows to adjust the settings.

### Tone Settings

1. Access the vehicle drawer on the touchscreen.
2. Press **SETTINGS**.
3. Press **Sound**.
4. Press **Tone Settings**.
5. Use the slider bar to adjust the settings.

### Speed Compensated Volume

1. Access the vehicle drawer on the touchscreen.
2. Press **SETTINGS**.
3. Press **Sound**.
4. Press **Speed Compensated Volume**.
5. Press a setting.

### Occupancy Mode (If Equipped)

1. Access the vehicle drawer on the touchscreen.
2. Press **SETTINGS**.
3. Press **Sound**.
4. Press **Occupancy Mode**.
5. Press a setting.

### Sound Mode (If Equipped)

1. Access the vehicle drawer on the touchscreen.
2. Press **SETTINGS**.
3. Press **Sound**.
4. Press **Sound Mode**.
5. Press a setting.

## SETTING THE CLOCK AND DATE

1. Access the vehicle drawer on the touchscreen.
2. Press **SETTINGS**.
3. Press **Clock**.
4. Set the time.

**Note:** The **AM** and **PM** options are not available if **24-hour mode** is on.

5. Press the arrows to adjust the settings.

### Switching Automatic Time Updates On and Off

1. Access the vehicle drawer on the touchscreen.
2. Press **SETTINGS**.
3. Press **Clock**.
4. Switch **Automatic time zone update** on or off.

# Audio System - Vehicles With: 15 Inch Screen

## AM/FM RADIO

### AM/FM RADIO LIMITATIONS

The further you travel from an AM or FM station, the weaker the signal and the weaker the reception.

Hills, mountains, tall buildings, bridges, tunnels, freeway overpasses, parking garages, dense tree foliage and thunderstorms can interfere with the reception.

When you pass a ground-based broadcast repeating tower, a stronger signal may overtake a weaker one and result in the audio system muting.

### SELECTING A RADIO STATION

#### Manually Selecting a Radio Station



Press the button to activate the tuner, and then slide or tap your finger anywhere on the scale to select a radio station. Press - or + to fine tune.

#### Using Direct Tune

1. Press **Direct Tune** to open the number pad.
2. Enter the station you prefer.

**Note:** You can only enter a valid station for the audio source you are currently listening to.

#### Using Seek



Press either button. The system stops at the first station it finds in that direction.



## Using the Station List

1. Press **Browse**.

**Note:** Available on FM radio only.

2. Select a station.

## DIGITAL RADIO (IF EQUIPPED)

### WHAT IS DIGITAL RADIO

HD Radio™ technology is the digital evolution of analog AM/FM radio.

For additional information, visit [www.HDRadio.com](http://www.HDRadio.com).

HD Radio Technology is manufactured under license from iBiquity Digital Corporation and foreign patents. HD Radio and the HD and HD Radio logos are proprietary trademarks of DTS. The vehicle manufacturer and DTS are not responsible for the content sent using HD Radio technology. Content may be changed, added or deleted at any time at the station owner's discretion.

### HOW DOES DIGITAL RADIO WORK

Your system has a special receiver that allows it to receive digital broadcasts in addition to analog broadcasts.

HD1 signifies the main programming status and is available in both analog and digital broadcasts. Other multicast stations are only available digitally and could contain new or different content.

**Note:** When the system first receives an HD1 station, it plays the station in the analog version until it verifies the station is an HD Radio station. Then it shifts to the digital version.

**Note:** There is an audio mute delay when switching to an HD2 or HD3 station because the system has to reacquire and decode the digital signal.

# Audio System - Vehicles With: 15 Inch Screen

## DIGITAL RADIO LIMITATIONS

If you are outside the reception area, the system could not work.

If you are on the fringe of the reception area, the station could mute due to weak signal strength.

**Note:** *If you are listening to HD1, the system changes back to the analog broadcast until the digital broadcast is available again. If you are listening to any other multicast channels, the station mutes and stays muted unless it is able to connect to the digital signal again.*

Depending on the station quality, you could hear a slight sound change when the station changes between analog and digital audio.

You cannot access a saved HD station if your vehicle is outside the station's reception area.

## SWITCHING DIGITAL RADIO RECEPTION ON AND OFF

1. Access the vehicle drawer on the touchscreen.
2. Press **SETTINGS**.
3. Press **Radio**.
4. Switch **HD Radio** on or off.

## DIGITAL RADIO INDICATORS

### HD Radio Indicator

The indicator appears when HD Radio is on and you tune to a station broadcasting HD Radio technology.



The color of the indicator changes to indicate the system status.

Gray indicates the system is acquiring a digital station.

Orange indicates digital audio is playing.

### Multicast Indicator

The multicast indicator appears if the current station is broadcasting multiple digital broadcasts. The highlighted numbers indicate additional digital channels available.

**Note:** *For stations that have more than one HD multicast, the HD indicator and radio text appears as a button. Press the button to cycle through all of the HD stations on that specific frequency.*

## SATELLITE RADIO (IF EQUIPPED)

### WHAT IS SATELLITE RADIO

Your factory-installed SiriusXM radio system includes a limited subscription term, which begins on the date of sale or lease of your vehicle. See an authorized dealer for availability.

For additional information about extended subscription terms, visit [www.SiriusXM.com](http://www.SiriusXM.com) in the United States, [www.SiriusXM.ca](http://www.SiriusXM.ca) in Canada, or call SiriusXM at 1-888-539-7474.

# Audio System - Vehicles With: 15 Inch Screen

**Note:** *SiriusXM reserves the unrestricted right to change, rearrange, add or delete programming including canceling, moving or adding particular channels, and its prices, at any time, with or without notice to you. Neither SiriusXM and its affiliates nor Ford Motor Company and its affiliates will be liable to you or any third party for any such modification, suspension or termination.*

## SATELLITE RADIO LIMITATIONS

For optimal reception performance, keep the antenna clear of snow and ice build-up and keep luggage and other material as far away from the antenna as possible. Placing luggage over the antenna may reduce performance. Factory-installed and aftermarket vehicle structures including, but not limited to, roof racks and soft top roofs in a partially open position could reduce reception performance.

Hills, mountains, tall buildings, bridges, tunnels, freeway overpasses, parking garages, dense tree foliage and thunderstorms can interfere with your reception.

When you pass a ground-based broadcast-repeating tower, a stronger signal may overtake a weaker one and could result in the audio system muting. Your display could show an error message to indicate the interference.

## LOCATING THE SATELLITE RADIO IDENTIFICATION NUMBER

1. Select SiriusXM as the audio source.
2. Tune to channel 0.

## SELECTING A CHANNEL

### Manually Selecting a Channel

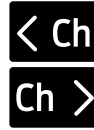

Press the button to find the previous or next available radio channel.

### Linear Tuner

The linear tuner is displayed when manually selecting a channel. You can swipe left or right on the linear tuner carousel to navigate through the channel list. Tap on a channel title to listen to it.

### Using Direct Tune

1. Press the channel up or down button to open the linear tuner screen.
2. Press **Direct Tune** to open the number pad.
3. Enter the channel you prefer.

### Using Browse

1. Press **Browse**.
2. Select a channel.

## SATELLITE RADIO SETTINGS

### Subscription

Your subscription status is displayed. You can subscribe or manage your subscription directly from the touchscreen.

### Listener Add/Switch

You can create up to five listener profiles per SiriusXM account. Each listener profile can be personalized with a name and profile image.

**Note:** *Requires a trial or active subscription to use.*

## Audio System - Vehicles With: 15 Inch Screen

---

**Note:** A default profile is available when no listener profiles are created.

### SiriusXM Favorites

SiriusXM Favorites are shown for the active listener profile. While you are listening to SiriusXM, you can save favorites by:

- Tapping the currently tuned channel or show logo on the SiriusXM audio screen. A favorite icon appears next to the logo when it is saved as a favorite.
- Tuning to a channel or show you want to save as a favorite. Navigate to the SiriusXM Favorites screen and press the Add Current button. The currently tuned channel or show is saved as a favorite.
- Saving a radio preset. This saves the currently tuned SiriusXM channel or show as a favorite.

**Note:** Requires a trial or active subscription to use.

### Listening History

Listening history is a list of recently listened to SiriusXM content and is shown for the active listener profile. You can view, manage and reset the listening history using the controls on the touchscreen.

**Note:** Requires a trial or active subscription to use.

### Listener Settings

Listener settings apply to the active listener profile.

**Note:** Requires a trial or active subscription to use.

**Note:** A default profile is available when no listener profiles are created.

### Help and Support

You can contact SiriusXM Customer Care directly from SYNC and view information required to manage your SiriusXM account.



# Audio System - Vehicles With: 15 Inch Screen

## AUDIO SYSTEM – TROUBLESHOOTING

### AUDIO SYSTEM – INFORMATION MESSAGES

#### Satellite Radio Troubleshooting

Error Message	Potential Effects	Recommended Action
Connectivity Disabled	Internet streaming and On Demand shows are unavailable and some SiriusXM features are disabled.	Internet connectivity is turned off. See <b>Connected Vehicle</b> (page 485).
No Internet	Audio system may mute. Switch to Satellite button may be displayed on the SiriusXM audio screen if the channel is also available via satellite.	SYNC attempts to connect. See <b>Satellite Radio Limitations</b> (page 507). Switch to a satellite connection for the current channel if the option is available.
No Satellite Signal	Audio system may mute. Switch to Internet button may be displayed on the SiriusXM audio screen if the channel is also available via streaming.	Antenna may be obstructed or satellite reception is weak in your location. See <b>Satellite Radio Limitations</b> (page 507). Switch to an internet connection for the current channel if the option is available.
Slow Network Connection	Audio system may mute while the audio attempts to load.	Allow some time for the audio to load or tune to a different channel.
Channel Unavailable	Audio system may mute. Radio may tune to a different channel.	A temporary update may be in progress. Allow some time before retrying to tune to the channel. If the issue continues, the channel may no longer be available.
Episode Unavailable	Audio system may mute. Radio may tune to a different channel.	A temporary update may be in progress. Allow some time before retrying to play the episode. If the issue continues, the episode may no longer be available.

## Audio System - Vehicles With: 15 Inch Screen

Error Message	Potential Effects	Recommended Action
Something went wrong	Audio system may mute. Radio may tune to a different channel.	Allow some time and retry the action.
Subscribe to Listen	Cannot listen to selected content. Content may appear grayed out and some features may be disabled.	<p>Your subscription has expired or you have not yet subscribed for access to the listed content. Navigate to Subscription under the Satellite Radio Settings menu. If you have an active subscription which includes the listed channel or content and you see this error, you may need to refresh your radio. To refresh your SiriusXM radio, visit <a href="http://www.siriusxm.com/refresh">www.siriusxm.com/refresh</a> in the US, or <a href="http://www.siriusxm.ca/refresh">www.siriusxm.ca/refresh</a> in Canada.</p> <p>You may need to provide your SiriusXM Radio identification number. See <b>Locating the Satellite Radio Identification Number</b> (page 497).</p>

## Audio System - Vehicles With: 15 Inch Screen

Error Message	Potential Effects	Recommended Action
Upgrade to Listen	Cannot listen to selected content. Content may appear grayed out and some features may be disabled.	<p>Your subscription does not include access to the listed content. You may need to upgrade your subscription. Navigate to Subscription under the Satellite Radio Settings menu. If you have an active subscription which includes the listed channel or content and you see this error, you may need to refresh your radio. To refresh your SiriusXM radio, visit <a href="http://www.siriusxm.com/refresh">www.siriusxm.com/refresh</a> in the US, or <a href="http://www.siri-usxm.ca/refresh">www.siri-usxm.ca/refresh</a> in Canada. You may need to provide your SiriusXM Radio identification number. See <b>Locating the Satellite Radio Identification Number</b> (page 497).</p>
Location Restricted Content	Audio may mute. Not available in your location or Unable to determine your location may be displayed.	Content is not available in your location or SiriusXM is unable to determine your location. Tuning to a different channel may resolve the issue.
Channel Blocked	Audio may mute. Radio may tune to a different channel.	<p>The Block Explicit Content filter is turned on. Navigate to Listener Settings under the Satellite Radio Settings menu to access the Block Explicit Content filter. Navigate to Listener Settings. See <b>Satellite Radio Settings</b> (page 507).</p>
Antenna Problem or Hardware Problem	Audio may mute. Access to SiriusXM features may be unavailable.	If issue persists, you may need to visit an authorized dealer for service.

## Audio System - Vehicles With: 15 Inch Screen

<b>Error Message</b>	<b>Potential Effects</b>	<b>Recommended Action</b>
SiriusXM Updating...	Audio may mute.	Allow SiriusXM some time to complete updating.
Loading...	Audio may mute. Content may be temporarily unavailable while loading.	No action necessary. If loading time is longer than usual, See <b>Satellite Radio Settings</b> (page 507).
SiriusXM Loading...	Audio may mute. Content and controls may be temporarily unavailable.	No action necessary. Allow SiriusXM some time to finish loading.

# Center Display Overview - Vehicles With: 12.3 Inch Screen

## CENTER DISPLAY PRECAUTIONS



**WARNING:** Driving while distracted can result in loss of vehicle control, crash and injury. We strongly recommend that you use extreme caution when using any device that may take your focus off the road. Your primary responsibility is the safe operation of your vehicle. We recommend against the use of any hand-held device while driving and encourage the use of voice-operated systems when possible. Make sure you are aware of all applicable local laws that may affect the use of electronic devices while driving.

## CENTER DISPLAY LIMITATIONS

### Speed-restricted Features

For your safety, some features are not available while the vehicle is in motion at or above 5 mph (8 km/h). Settings that are not critical while driving your vehicle are shown as restricted on your display. Some of these settings include:

- Software updates.
- Personal profiles setup.
- Valet mode setup.
- Driver assistance settings.
- MyKey setup.
- Door keypad code setup.

These restricted features become available when your vehicle is no longer in motion.

## STATUS BAR

The bar is on top of the display and indicates the status of your vehicle's features.

### Audio System



Audio system muted.

### Connected Device



Cell phone microphone muted.



Phone call in progress.



Media player connected using **Bluetooth®**.



Cell phone network signal strength.



Cell phone roaming.



Text message received.



Unread email message.



Automatic crash notification system off.



Cell phone battery status.

### Vehicle Data



Wi-Fi available.

# Center Display Overview - Vehicles With: 12.3 Inch Screen



Wi-Fi connected.



Vehicle data sharing on.



Vehicle data sharing off.



Vehicle location sharing on.



Vehicle data and vehicle location sharing on.

## Vehicle Software Update



Vehicle software update available.



Vehicle software update requires schedule.



Vehicle software update requires consent.



Vehicle software update requires Wi-Fi.



Vehicle software update schedule reminder.



Vehicle software update not successful.



Vehicle software update successful.

## Wireless Accessory Charger



Wireless accessory charger active.

## FEATURE BAR

The feature bar is located on the bottom of the display and allows you to access vehicle features.



Press to use the radio, a USB, a media player or a **Bluetooth®** device.



Press to make calls and access the phonebook on your cell phone.



Press to use the navigation system.



Press to replace this button with a shortcut to a feature or setting.



Press to search for and use compatible apps on your iOS or Android device.



Press to adjust system settings.



Press to view features.



**Note:** The icon may be different depending on your vehicle.

# Center Display Overview - Vehicles With: 12.3 Inch Screen

---

## INFORMATION ON DEMAND SCREEN

The information on demand screen displays cards on the side of the display and allows you to see information from different features.



Press the button to view the next card.



Press the button to view the previous card.



Press the button to view available cards.

## REBOOTING THE CENTER DISPLAY

You can reboot the center display using the controls on the steering wheel.

1. Simultaneously press and hold the seek forward and audio system power button for 10 seconds.

# Center Display Overview - Vehicles With: 15 Inch Screen

## CENTER DISPLAY PRECAUTIONS



**WARNING:** Driving while distracted can result in loss of vehicle control, crash and injury. We strongly recommend that you use extreme caution when using any device that may take your focus off the road. Your primary responsibility is the safe operation of your vehicle. We recommend against the use of any hand-held device while driving and encourage the use of voice-operated systems when possible. Make sure you are aware of all applicable local laws that may affect the use of electronic devices while driving.

## CENTER DISPLAY LIMITATIONS

### Speed-restricted Features

For your safety, some features are not available while the vehicle is in motion at or above 5 mph (8 km/h). Settings that are not critical while driving your vehicle are shown as restricted on your display. Some of these settings include:

- Software updates.
- Personal profiles setup.
- Valet mode setup.
- Driver assistance settings.
- MyKey setup.
- Door keypad code setup.

These restricted features become available when your vehicle is no longer in motion.

## STATUS BAR

The bar is on top of the display and indicates the status of your vehicle's features. It also contains the Vehicle and Application drawers. See **Accessing Feature Drawers** (page 517).

### Status Area

The status area is on the right side of the status bar and provides information about vehicle features.

### Audio System



Audio system muted.

### Connected Device



Cell phone microphone muted.



Phone call in progress.



Media player connected using **Bluetooth®**.



Cell phone network signal strength.



Cell phone roaming.



Text message received.



Unread email message.



Automatic crash notification system off.



Cell phone battery status.



# Center Display Overview - Vehicles With: 15 Inch Screen

## Vehicle Data



Wi-Fi available.



Wi-Fi connected.



Vehicle data sharing on.



Vehicle data sharing off.



Vehicle location sharing on.



Vehicle data and vehicle location sharing on.

## Wireless Accessory Charger



Wireless accessory charger active.

## Action Area

The action area is on the left side of the status bar and contains status updates that may require your action. Press the icons in the action area to learn more.

## Vehicle Software Update



Vehicle software update available.



Vehicle software update requires schedule.



Vehicle software update requires consent.



Vehicle software update requires Wi-Fi.



Vehicle software update schedule reminder.



Vehicle software update not successful.



Vehicle software update successful.

## ACCESSING FEATURE DRAWERS

### Application Drawer

● ● ● Press the button to open and close the application drawer. It contains system and connected device applications.

**Note:** *The icon may change depending on your personalization settings.*

### Vehicle Drawer



Press the button to open and close the vehicle drawer. It contains vehicle feature settings.

## REBOOTING THE CENTER DISPLAY

You can reboot the center display using the controls on the steering wheel.

1. Simultaneously press and hold the seek forward and volume down button for 10 seconds.

# Voice Interaction - Vehicles With: 15 Inch Screen

## WHAT IS VOICE INTERACTION

Ford assistant allows you to control vehicle features using your voice via conversational requests.

## SETTING THE WAKE WORD

1. Access the vehicle drawer on the touchscreen.
2. Press **SETTINGS**.
3. Press the **Voice Assistant**.
4. Press **Preferred Wake Word**.
5. Select a wake word.

## BEGINNING A VOICE INTERACTION

Say the selected wake word.



Press the button on the steering wheel.

## VOICE INTERACTION EXAMPLES

**Note:** To take advantage of all the Ford assistant capabilities make sure you enable your modem, and Ford assistant is enabled in your Connectivity settings screen. See **Enabling and Disabling the Modem** (page 485).

### General Examples

Command	Result
Start Over.	The system resets the current Ford assistant.
Cancel.	The system ends the current Ford assistant.
Next Page.	The system goes to the next page.
Previous Page.	The system goes to the previous page.
Help.	The system displays a list of available commands you can use on the current screen.

### Entertainment Examples

Command	Result
Play The Beatles.	The system plays the selected music.
Show music by The Beatles.	The system shows the selected music.
Tune to FM 101.9.	The system tunes the radio to 101.9 FM.
Set the station to Sirius Channel 2.	The system tunes the radio to Sirius Channel 2.

# Voice Interaction - Vehicles With: 15 Inch Screen

## Climate Examples

Command	Result
Set the temperature to low.	The system sets the temperature to the minimum.
Set the temperature to 72°F (22°C).	The system sets the temperature to 72°F (22°C).

## Phone Examples

Command	Result
Call Henry.	The system calls Henry using your connected device.
Dial (phone number).	The system dials the selected phone number.
Send a text message to Henry.	The system begins a dictated text message.
Read my message from Henry.	The system reads you the most recent message from Henry.

## Apps Examples

Command	Result
Mobile Apps.	The system prompts you to say the name of an app to start it on the system.
List Mobile Apps.	The system will list all of the currently available mobile apps.
Find Mobile Apps	The system will search and connect to compatible apps running on your mobile device.

## Navigation Examples

Command	Result
Drive to 125 Main Street, New York.	The system begins guided navigation to the address.
Where is ___	The system searches for the requested point of interest.
Show me directions to Oakwood Boulevard and Pelham Road.	The system shows directions to the selected intersection.
Cancel route.	The system ends guided navigation to the destination.

# Voice Interaction - Vehicles With: 15 Inch Screen

## Maintenance and Roadside Assistance Examples

Command	Result
Call roadside assistance.	Your vehicle calls the roadside assistance phone number.

**Note:** When you are not driving, additional commands are available using popular chat applications. Use FordPass to set up a conversation with your Ford Assistant.

**Note:** Internet and data connectivity are needed to recognize a phrase or request.

## Vehicle Information Examples

Command	Result
How does cruise control work?	Information about the feature appears on the center display.
What is that warning light?	Information about the warning light appears on the center display.
Are there any recalls on my vehicle?	Information about open recalls appears on the center display.

## Charging Examples

Command	Result
Change my charging times.	Information about the time and location of the next charge appears on the center display.
Show me the charging schedule.	Shows the charging display in the vehicle.
Change my charge schedule.	Shows the charging display in the vehicle.

# Voice Interaction - Vehicles With: 12.3 Inch Screen

## WHAT IS VOICE INTERACTION

Ford assistant allows you to control vehicle features using your voice via conversational requests.

## SETTING THE WAKE WORD

1. Press the Settings option on the feature bar.
2. Press the Voice Control button.
3. Switch on Listen for Wake Word.
4. Press Preferred Wake Word
5. Select a wake word.

## BEGINNING A VOICE INTERACTION

Say the selected wake word.



Press the button on the steering wheel.

## VOICE INTERACTION EXAMPLES

**Note:** To take advantage of all the Ford assistant capabilities make sure you enable your modem, and Ford assistant is enabled in your Connectivity settings screen. See **Enabling and Disabling the Modem** (page 485).

### General Examples

Command	Result
Start Over.	The system resets the current Ford assistant.
Cancel.	The system ends the current Ford assistant.
Next Page.	The system goes to the next page.
Previous Page.	The system goes to the previous page.
Help.	The system displays a list of available commands you can use on the current screen.

### Entertainment Examples

Command	Result
Play The Beatles.	The system plays the selected music.
Show music by The Beatles.	The system shows the selected music.
Tune to FM 101.9.	The system tunes the radio to 101.9 FM.
Set the station to Sirius Channel 2.	The system tunes the radio to Sirius Channel 2.

# Voice Interaction - Vehicles With: 12.3 Inch Screen

## Climate Examples

Command	Result
Set the temperature to low.	The system sets the temperature to the minimum.
Set the temperature to 72°F (22°C).	The system sets the temperature to 72°F (22°C).

## Phone Examples

Command	Result
Call Henry.	The system calls Henry using your connected device.
Dial (phone number).	The system dials the selected phone number.
Send a text message to Henry.	The system begins a dictated text message.
Read my message from Henry.	The system reads you the most recent message from Henry.

## Apps Examples

Command	Result
Mobile Apps.	The system prompts you to say the name of an app to start it on the system.
List Mobile Apps.	The system will list all of the currently available mobile apps.
Find Mobile Apps	The system will search and connect to compatible apps running on your mobile device.

## Navigation Examples

Command	Result
Drive to 125 Main Street, New York.	The system begins guided navigation to the address.
Where is ___	The system searches for the requested point of interest.
Show me directions to Oakwood Boulevard and Pelham Road.	The system shows directions to the selected intersection.
Cancel route.	The system ends guided navigation to the destination.

## Voice Interaction - Vehicles With: 12.3 Inch Screen

### Maintenance and Roadside Assistance Examples

Command	Result
Call roadside assistance.	Your vehicle calls the roadside assistance phone number.

**Note:** When you are not driving, additional commands are available using popular chat applications. Use FordPass to set up a conversation with your Ford Assistant.

**Note:** Internet and data connectivity are needed to recognize a phrase or request.

### Vehicle Information Examples

Command	Result
How does cruise control work?	Information about the feature appears on the center display.
What is that warning light?	Information about the warning light appears on the center display.
Are there any recalls on my vehicle?	Information about open recalls appears on the center display.

### Charging Examples

Command	Result
Change my charging times.	Information about the time and location of the next charge appears on the center display.
Show me the charging schedule.	Shows the charging display in the vehicle.
Change my charge schedule.	Shows the charging display in the vehicle.

# Alexa Built-In

## WHAT IS ALEXA BUILT-IN

Allows you to use Alexa in your vehicle for auto specific use cases on the road and gives you access to an ever evolving number of skills that help to make your life more productive, entertaining, and connected while using your vehicle.

## ALEXA BUILT-IN REQUIREMENTS

To use Alexa, all of the following must occur:

- Your vehicle modem is enabled.
- You are logged into an existing Amazon account.
- Vehicle location services are enabled.
- Vehicle connectivity and vehicle data sharing is enabled.

## SIGNING INTO YOUR ACCOUNT - VEHICLES WITH: 12.3 INCH SCREEN



Press the button in the status bar and follow the on-screen prompts.

To sign in using the settings menu:

1. Press **Settings** on the touchscreen.
2. Press **Amazon Alexa**.
3. Press **Get Started**.
4. Sign into your account by either scanning the QR code or entering the on-screen code into the Amazon website.
5. Once logged in, follow the on-screen prompts.
6. When complete, the vehicle informs you that Alexa is ready to be used in the vehicle.

## Signing Out of Your Account

1. Press **Settings** on the touchscreen.
2. Press **Amazon Alexa**.
3. Press **Sign Out**.

## SIGNING INTO YOUR ACCOUNT - VEHICLES WITH: 15 INCH SCREEN



Press the button in the status bar and follow the on-screen prompts.

To sign in using the settings menu:

1. Access the vehicle drawer.
2. Press **SETTINGS**.
3. Press **Amazon Alexa**.
4. Press **Get Started**.
5. Sign into the Amazon account by either scanning the QR code or entering the on-screen code into the Amazon website.
6. Once logged in, follow the on-screen prompts.
7. When complete, the vehicle informs you that Alexa is ready to be used in the vehicle.

## Signing Out of Your Account

1. Access the vehicle drawer.
2. Press **SETTINGS**.
3. Press **Amazon Alexa**.
4. Press **Sign Out**.

## USING ALEXA BUILT-IN

To use Alexa, say "Alexa" or press the voice interaction button on the steering wheel and then say "Alexa" to invoke Alexa to start listening.



# Alexa Built-In

**Note:** *If the wake word is not enabled, you can only use the voice interaction button.*

You can use Alexa for the following and more:

- Entertainment.
- Hands-free calling.
- Traffic and navigation.
- Vehicle controls.
- Smart home device control.
- Weather and news information.

## ALEXA BUILT-IN SETTINGS - VEHICLES WITH: 12.3 INCH SCREEN

### Enabling the Wake Word

1. Press **Settings** on the touchscreen.
2. Press **Amazon Alexa**.
3. Switch **Listen for Wake Word** on or off.

**Note:** *If the wake word is not enabled, you can only use the voice interaction button.*

### Contact List

Displays a list of connected phones and contact sharing status for each phone.

To change the contact sharing status:

1. Press **Settings** on the touchscreen.
2. Press **Amazon Alexa**.
3. Press **Contact List**.
4. Enable or disable sharing for each phone.

**Note:** *You can share contacts from more than one phone at a time.*

**Note:** *If a contact list is not shared, hands-free calling does not work via Alexa.*

### Things to Try

Learn more about what you can do with Alexa by browsing the things to try.

1. Press **Settings** on the touchscreen.
2. Press **Amazon Alexa**.
3. Press **Things to Try**.

## ALEXA BUILT-IN SETTINGS - VEHICLES WITH: 15 INCH SCREEN

### Enabling the Wake Word

1. Access the vehicle drawer.
2. Press **SETTINGS**.
3. Press **Amazon Alexa**.
4. Switch **Listen for Wake Word** on or off.

**Note:** *If the wake word is not enabled, you can only use the voice interaction button.*

### Contact List

Displays a list of connected phones and contact sharing status for each phone.

To change the contact sharing status:

1. Access the vehicle drawer.
2. Press **SETTINGS**.
3. Press **Amazon Alexa**.
4. Press **Contact List**.
5. Enable or disable sharing for each phone.

**Note:** *You can share contacts from more than one phone at a time.*

**Note:** *If a contact list is not shared, hands-free calling does not work via Alexa.*

### Things to Try

Learn more about what you can do with Alexa by browsing the things to try.

1. Access the vehicle drawer.

## Alexa Built-In

---

2. Press **SETTINGS**.
3. Press **Amazon Alexa**.
4. Press **Things to Try**.

# Phone - Vehicles With: 12.3 Inch Screen

## PHONE PRECAUTIONS



**WARNING:** Driving while distracted can result in loss of vehicle control, crash and injury. We strongly recommend that you use extreme caution when using any device that may take your focus off the road. Your primary responsibility is the safe operation of your vehicle. We recommend against the use of any hand-held device while driving and encourage the use of voice-operated systems when possible. Make sure you are aware of all applicable local laws that may affect the use of electronic devices while driving.

## CONNECTING YOUR PHONE

Go to the settings menu on your device and switch **Bluetooth®** on.



Press the phone option on the feature bar.

1. Press **Add Phone**.

**Note:** A prompt alerts you to search for your vehicle on your cell phone.

2. Select your vehicle on your cell phone.

**Note:** A number appears on your cell phone and on the touchscreen.

3. Confirm the number on your cell phone matches the number on the touchscreen.

**Note:** The touchscreen indicates that you have successfully paired your cell phone.

4. Download the phonebook from your cell phone when you are prompted.

**Note:** If you pair more than one cell phone, use the phone settings on the center display to specify the primary phone. You can change this setting at any time.

## PHONE MENU

This menu becomes available after pairing a phone.

### Recent Call List

Display and select an entry from a list of previous calls.

### Contacts

Display a smart search form to look up your contacts. Use the List button to alphabetically sort your contacts.

### Favorites

Display the list of favorite contacts that are set up on your phone.

### Messaging

Displays the list of text messages to read, listen to, or respond to.

### Email

Displays the list of emails to read, listen to, or respond to.

### Phone List

Display the list of paired or connected devices that you can select.

**Note:** Up to 12 devices can be stored.

### Do Not Disturb

Reject incoming calls and switch ring tones and alerts off.

### Phone Keypad

Directly dial a number.

## Phone - Vehicles With: 12.3 Inch Screen

---

### Voice Control

Press the button and say a command to use the Google or Siri voice assistant available on your connected phone to access supported features.

**Note:** *Some features under the phone menu may not be available if the feature is not supported through the phone.*

# Phone - Vehicles With: 12.3 Inch Screen

## MAKING AND RECEIVING A PHONE CALL

### Making Calls

**To call a number in your contacts, select:**

Menu Item	Action and Description
Contacts	You can then select the name of the contact you want to call. Any numbers stored for that contact display along with any stored contact photos. You can then select the number that you want to call. The system begins the call.

**To call a number from your recent calls, select:**

Menu Item	Action and Description
Recent Call List	You can then select an entry that you want to call. The system begins the call.

**To call a number from your favorites, select:**

Menu Item	Action and Description
Favorites	You can then select an entry that you want to call. The system begins the call.

**To call a number that is not stored in your phone, select:**

Menu Item	Action and Description
Phone Keypad	Select the digits of the number you wish to call.
Call	The system begins the call.

Pressing the backspace button deletes the last digit you typed.

### Receiving Calls

During an incoming call, an audible tone sounds. Caller information appears in the display if it is available.

**To accept the call, select:**

Menu Item
Accept

**Note:** You can also accept the call by pressing the phone button on the steering wheel.

**To reject the call, select:**

Menu Item
Reject

Ignore the call by doing nothing. The system logs it as a missed call.

### During a Phone Call

During a phone call, the contacts name and number display on the screen along with the call duration.

The phone status items are also visible:

- Signal Strength.
- Battery.

You can select any of the following during an active phone call:

## Phone - Vehicles With: 12.3 Inch Screen

Item	
End Call	Immediately end a phone call. You can also press the button on the steering wheel.
Keypad	Press this to access the phone keypad.

Item	
Mute	You can switch the microphone off so the caller does not hear you.
Privacy	Transfer the call to the cell phone or back to the touch-screen.

### SENDING AND RECEIVING A TEXT MESSAGE

Menu Item	Description
Hear It	Hear the text message.
View	View the text message.
Call	Call the sender.
Reply	Reply to the text message with a standard text message.

## Phone - Vehicles With: 12.3 Inch Screen

---

### **SWITCHING TEXT MESSAGE NOTIFICATION ON AND OFF**

The settings on your device must be enabled to receive text message notifications on the center display. Check your device settings to enable these features.

# Phone - Vehicles With: 15 Inch Screen

## PHONE PRECAUTIONS



**WARNING:** Driving while distracted can result in loss of vehicle control, crash and injury. We strongly recommend that you use extreme caution when using any device that may take your focus off the road. Your primary responsibility is the safe operation of your vehicle. We recommend against the use of any hand-held device while driving and encourage the use of voice-operated systems when possible. Make sure you are aware of all applicable local laws that may affect the use of electronic devices while driving.

## CONNECTING YOUR PHONE

Connecting your phone stores contact and call data on your vehicle.

**Note:** *This data is used to provide intelligent suggestions. You can switch this off in the touchscreen settings menu. See **Personal Profile Settings** (page 544).*

**Note:** *Unpairing your phone removes the contact and call data from your vehicle and stops intelligent call suggestions.*

1. Make sure **Bluetooth®** is enabled on your device.
2. Access the vehicle drawer on the touchscreen.
3. Press **SETTINGS**.
4. Press **Phone List**.
5. Select **Add Phone**.
6. Follow the instructions on the screen to pair your device.

## PHONE MENU



Press to view your favorite contacts.



Press to view your recent calls.



Press to view your contacts



Press to use the phone keypad.



Press to display recent text messages.



Press to view recent emails.

Press the down arrow to view additional items for a connected device.



Press to begin a voice interaction.



Press to switch to a different connected device.



Press to mute notifications.



Press to access phone settings.



# Phone - Vehicles With: 15 Inch Screen

## MAKING AND RECEIVING A PHONE CALL

### Making Calls

**To call a number in your contacts, select:**

Menu Item	Action and Description
Contacts	You can then select the name of the contact you want to call. Any numbers stored for that contact display along with any stored contact photos. You can then select the number that you want to call. The system begins the call.

**To call a number from your recent calls, select:**

Menu Item	Action and Description
Recent Call List	You can then select an entry that you want to call. The system begins the call.

**To call a number from your favorites, select:**

Menu Item	Action and Description
Favorites	You can then select an entry that you want to call. The system begins the call.

**To call a number that is not stored in your phone, select:**

Menu Item	Action and Description
Phone Keypad	Select the digits of the number you wish to call.
Call	The system begins the call.

Pressing the backspace button deletes the last digit you typed.

### Receiving Calls

During an incoming call, an audible tone sounds. Caller information appears in the display if it is available.

**To accept the call, select:**

Menu Item
Accept

**Note:** You can also accept the call by pressing the phone button on the steering wheel.

**To reject the call, select:**

Menu Item
Reject

Ignore the call by doing nothing. The system logs it as a missed call.

### During a Phone Call

During a phone call, the contacts name and number display on the screen along with the call duration.

The phone status items are also visible:

- Signal Strength.
- Battery.

You can select any of the following during an active phone call:

## Phone - Vehicles With: 15 Inch Screen

---

Item	
End Call	Immediately end a phone call. You can also press the button on the steering wheel.
Keypad	Press this to access the phone keypad.

Item	
Mute	You can switch the microphone off so the caller does not hear you.
Privacy	Transfer the call to the cell phone or back to the touch-screen.

### SENDING AND RECEIVING A TEXT MESSAGE

Menu Item	Description
Hear It	Hear the text message.
View	View the text message.
Call	Call the sender.
Reply	Reply to the text message with a standard text message.

## Phone - Vehicles With: 15 Inch Screen

---

### **SWITCHING TEXT MESSAGE NOTIFICATION ON AND OFF**

The settings on your device must be enabled to receive text message notifications on the center display. Check your device settings to enable these features.

## Bluetooth® - Vehicles With: 12.3 Inch Screen

### CONNECTING A BLUETOOTH® DEVICE

1. Make sure **Bluetooth®** is enabled on your device.
2. Press **Settings** on the touchscreen.
3. Press **Connectivity**.
4. Press **Bluetooth**.
5. Press **Add a Bluetooth Device**.

**Note:** A prompt alerts you to search for your vehicle on your device.

6. Select your vehicle on your device.

**Note:** A number appears on your device and on the touchscreen.

7. Confirm that the number on your device matches the number on the touchscreen.

**Note:** The touchscreen indicates that you have successfully paired your device.

The **Bluetooth®** word mark and logos are registered trademarks owned by **Bluetooth SIG, Inc.** and any use of such marks by Ford Motor Company is under license. Other trademarks and trade names are those of their respective owners.

### PLAYING MEDIA USING BLUETOOTH®



**WARNING:** Driving while distracted can result in loss of vehicle control, crash and injury. We strongly recommend that you use extreme caution when using any device that may take your focus off the road. Your primary responsibility is the safe operation of your vehicle. We recommend against the use of any

hand-held device while driving and encourage the use of voice-operated systems when possible. Make sure you are aware of all applicable local laws that may affect the use of electronic devices while driving.

Connect your device.



Press the audio button on the feature bar.



Press **Sources**.



Press the **Bluetooth®** option.



Press to play a track. Press again to pause the track.



Press to skip to the next track. Press and hold to fast forward through the track.



Press once to return to the beginning of a track. Repeatedly press to return to previous

tracks.

Press and hold to fast rewind through the track.

# Bluetooth® - Vehicles With: 15 Inch Screen

## CONNECTING A BLUETOOTH® DEVICE

1. Make sure **Bluetooth®** is enabled on your device.
2. Access the vehicle drawer.
3. Press **Connectivity**.
4. Press **Bluetooth**.
5. Switch **Bluetooth** on.
6. Press **Add a Bluetooth Device**.

**Note:** A prompt alerts you to search for your vehicle on your device.

7. Select your vehicle on your device.

**Note:** A number appears on your device and on the touchscreen.

8. Confirm that the PIN (personal identification number) on your device matches the number on the touchscreen.

**Note:** The touchscreen indicates that you have successfully paired your device.

The **Bluetooth®** word mark and logos are registered trademarks owned by **Bluetooth SIG, Inc.** and any use of such marks by Ford Motor Company is under license. Other trademarks and trade names are those of their respective owners.

## PLAYING MEDIA USING BLUETOOTH®



**WARNING:** Driving while distracted can result in loss of vehicle control, crash and injury. We strongly recommend that you use extreme caution when using any device that may take your focus off the road. Your primary responsibility is the safe operation of your vehicle. We recommend against the use of any

hand-held device while driving and encourage the use of voice-operated systems when possible. Make sure you are aware of all applicable local laws that may affect the use of electronic devices while driving.

Connect your device.



Press the button on the status bar to open the application drawer.



Press the **Bluetooth®** option.



Press to play a track. Press again to pause the track.



Press to skip to the next track.

Press and hold to fast forward through the track.



Press once to return to the beginning of a track. Repeatedly press to return to previous

tracks.

Press and hold to fast rewind through the track.

## Browsing your Media Library

When a compatible mobile device is connected to the vehicle, your media library will be accessible through the touchscreen. From the touchscreen, you can browse through songs, albums, artists, and playlists on your mobile device.

**Note:** This feature is dependent on the connected mobile device and the media application used.

**Note:** Browse feature functionality may be limited while driving.

# Apps - Vehicles With: 12.3 Inch Screen

## APP PRECAUTIONS



**WARNING:** Driving while distracted can result in loss of vehicle control, crash and injury. We strongly recommend that you use extreme caution when using any device that may take your focus off the road. Your primary responsibility is the safe operation of your vehicle. We recommend against the use of any hand-held device while driving and encourage the use of voice-operated systems when possible. Make sure you are aware of all applicable local laws that may affect the use of electronic devices while driving.

## APP REQUIREMENTS

When you start an app through the system for the first time, you could be asked to grant certain permissions. You can review and change the permissions that you have granted at any time when your vehicle is not moving. We recommend that you check your data plan before using your apps through the system. Using them could result in additional charges. We also recommend that you check the app provider's terms and conditions and privacy policy before using their app. Make sure that you have an active account for apps that you want to use through the system. Some apps will work with no setup. Others require you to configure some personal settings before you can use them.

## ACCESSING APPS



Select the apps option on the feature bar.

## ENABLING APPS ON AN IOS DEVICE



Select the apps option on the feature bar.

1. Select Mobile Apps Help.
2. Follow the instructions to pair and connect your device via **Bluetooth®** or with a USB cable.
3. Start the apps on your device that you want to use.
4. Select the app that you want to use on the touchscreen.

**Note:** Some apps may run through Apple CarPlay if it is enabled.

**Note:** Closing an app on your device will close it on the touchscreen.

**Note:** For troubleshooting assistance select Mobile Apps List under Mobile Apps Help.

## ENABLING APPS ON AN ANDROID DEVICE



Select the apps option on the feature bar.

1. Select Mobile Apps Help.
2. Follow the instructions to pair and connect your device via **Bluetooth®** or with a USB cable.
3. Start the apps on your device that you want to use.
4. Select **Find Mobile Apps**.
5. Select the app that you want to use on the touchscreen.

**Note:** Some devices may lose the ability to play music over USB when Mobile Apps are enabled.

**Note:** Some apps may run through Android Auto if it is enabled.

# Apps - Vehicles With: 12.3 Inch Screen

**Note:** Closing an app on your device will close it on the touchscreen.

**Note:** For troubleshooting assistance select Mobile Apps List under Mobile Apps Help.

## SWITCHING APPLE CARPLAY ON AND OFF

### Enabling Apple CarPlay with USB

1. Connect your device to a USB port.
2. Follow the instructions on your device and the touchscreen.

**Note:** Selecting "Enable Wireless CarPlay" on your device prepares the device for wireless CarPlay when you re-enter the vehicle.

### Enabling Apple CarPlay with Wireless

1. Pair your device to **Bluetooth®**.
2. Follow the instructions on your device and the touchscreen.

### Disabling Apple CarPlay



Select the settings option on the feature bar.

1. Press Phone List.
2. Select your device from the list.
3. Press Disable.

### Re-Enabling Apple CarPlay



Select the settings option on the feature bar.

1. Press Phone List.
2. Select your device from the list.
3. Press Connect to Apple CarPlay.

## SWITCHING ANDROID AUTO ON AND OFF

### Enabling Android Auto with USB

(If Equipped)

1. Connect your device to a USB port.
2. Follow the instructions on the touchscreen.

**Note:** Certain features of the system are not available when you are using Android Auto.

### Enabling Android Auto with Wireless

1. Pair your device to **Bluetooth®**.
2. Follow the instructions on your device and the touchscreen.

**Note:** Certain Android Devices do not support Android Auto Wireless. Please check your Android OS version for compatibility.

### Disabling Android Auto



Select the settings option on the feature bar.

1. Press Phone List.
2. Select your device from the list.
3. Press Disable.

### Re-Enabling Android Auto



Select the settings option on the feature bar.

1. Press Phone List.
2. Select your device from the list.
3. Press Connect to Android Auto.

# Apps - Vehicles With: 15 Inch Screen

## APP PRECAUTIONS



**WARNING:** Driving while distracted can result in loss of vehicle control, crash and injury. We strongly recommend that you use extreme caution when using any device that may take your focus off the road. Your primary responsibility is the safe operation of your vehicle. We recommend against the use of any hand-held device while driving and encourage the use of voice-operated systems when possible. Make sure you are aware of all applicable local laws that may affect the use of electronic devices while driving.

## APP REQUIREMENTS

When you start an app through the system for the first time, you could be asked to grant certain permissions. You can review and change the permissions that you have granted at any time when your vehicle is not moving. We recommend that you check your data plan before using your apps through the system. Using them could result in additional charges. We also recommend that you check the app provider's terms and conditions and privacy policy before using their app. Make sure that you have an active account for apps that you want to use through the system. Some apps will work with no setup. Others require you to configure some personal settings before you can use them.

## ACCESSING APPS



Press the button to open the application drawer.

## ENABLING APPS ON AN IOS DEVICE

 Select the apps option in the feature drawer.

1. If your device is connected via USB, switch Apple CarPlay off.
2. Connect your device to a USB port or pair and connect using Bluetooth.
3. If prompted to enable CarPlay, select Disable.
4. Start the apps on your device that you want to use through SYNC.

**Note:** *If you close the apps on your device, you will not be able to use them through the system.*

5. Select the app that you want to use on the touchscreen.

**Note:** *Connect your device to a USB port if you want to use a navigation app. When using a navigation app, keep your device unlocked and the app open.*

## ENABLING APPS ON AN ANDROID DEVICE



Select the apps option in the feature drawer.

1. If your device is connected via USB, switch Android Auto off.
2. Pair your device.
3. Start the apps on your device that you want to use through SYNC.

**Note:** *If you close the apps on your device, you will not be able to use them through the system.*

4. Select **Find Mobile Apps**.

**Note:** *The system searches and connects to compatible apps that are running on your device.*



# Apps - Vehicles With: 15 Inch Screen

---

5. Select the app that you want to use on the touchscreen.

**Note:** *Mobile Apps on your device use the USB port to establish a connection with SYNC. Some devices may lose the ability to play music over USB when Mobile Apps are enabled.*

## SWITCHING APPLE CARPLAY ON AND OFF

### Enabling Apple CarPlay with USB

1. Connect your device to a USB port.
2. Follow the instructions on your device and the touchscreen.

**Note:** *Selecting Enable Wireless CarPlay on your device prepares the device for wireless CarPlay when you re-enter the vehicle.*

### Enabling Apple CarPlay with Wireless

1. Pair your device to **Bluetooth®**.
2. Follow the instructions on your device and the touchscreen.

### Disabling Apple CarPlay

1. Access the vehicle drawer on the touchscreen.
2. Press **SETTINGS**.
3. Press **Phone List**.
4. Select your device from the list.
5. Press **Disable**.

### Re-Enabling Apple CarPlay

1. Access the vehicle drawer on the touchscreen.
2. Press **SETTINGS**.
3. Press **Phone List**.
4. Select your device from the list.

5. Press **Connect**.

## SWITCHING ANDROID AUTO ON AND OFF

### Enabling Android Auto with USB (If Equipped)

1. Connect your device to a USB port.
2. Follow the instructions on the touchscreen.

**Note:** *Certain features of the system are not available when you are using Android Auto.*

### Enabling Android Auto with Wireless

1. Pair your device to **Bluetooth®**.
2. Follow the instructions on your device and the touchscreen.

**Note:** *Certain Android Devices do not support Android Auto Wireless. Please check your Android OS version for compatibility.*

### Disabling Android Auto

1. Access the vehicle drawer on the touchscreen.
2. Press **SETTINGS**.
3. Press **Phone List**.
4. Select your device from the list.
5. Press **Disable**.

### Re-Enabling Android Auto

1. Access the vehicle drawer on the touchscreen.
2. Press **SETTINGS**.
3. Press **Phone List**.
4. Select your device from the list.
5. Press **Connect**.

# Personal Profiles

---

## HOW DO PERSONAL PROFILES WORK

This feature allows you to create multiple personal profiles enabling users to personalize vehicle's settings such as seats and mirrors, as well as non-positional settings like radio, navigation, driver assist system settings. Positional settings are saved by holding a memory seat button. Non-positional settings are saved you change a setting while a profile is active. You can create one profile for each preset memory seat button along with a guest profile.

### Recalling and Changing a Profile

You can recall a profile using the touchscreen or the preset button you selected when you created your profile. You can also link a remote control and a mobile device to your profile, which are used to recall it.

## ENABLING OR DISABLING PERSONAL PROFILES

1. Access the application drawer on the touchscreen.
2. Press Settings.
3. Press the Profiles button.
4. Switch Enable Profiles on or off.

When you switch on the Personal Profiles feature:

- Unlocking a door with a remote control or mobile device that is not linked to a driver profile does not change active profile, but remains in the last known profile. It does not change the positional settings.
- Pressing a memory seat button that is not linked to a driver profile or saved to a preset setting does not change active profile, but remains in the last known profile. It does not change the positional settings.
- Pressing a memory seat button that is not linked to a driver profile but is saved to a preset setting does not change active profile, but remains in the last known profile. It recalls the positional settings that you saved to that memory seat button.

When you switch off a Personal Profiles feature:

- Unlocking a door with a remote control or mobile device does not recall any non-positional settings but still recalls positional settings from the driver profile which the remote control or mobile device is linked to.
- Pressing a memory seat button that is not linked to a driver profile or saved to a preset setting recalls non-positional settings from the guest profile. It does not change the positional settings.
- Pressing a memory seat button that is linked to a driver profile or has saved to a preset setting recalls non-positional settings from the guest profile. It recalls the positional settings that you saved to that memory seat button.

# Personal Profiles

## CREATING A PERSONAL PROFILE

Use the touchscreen to create a personal profile.

1. Switch the vehicle on and make sure the transmission is in park (P).
2. Access the vehicle drawer on the touchscreen
3. Press **SETTINGS**.
4. Press **Personal Profiles**.
5. Follow the instructions on the display.

### Using Remote Vehicle Setup (if Equipped)

When creating your first personal profile online at the owner website or using FordPass, you can use remote vehicle setup to set up some non-positional settings such as radio presets, navigation favorites, charging locations nearby, and departure and comfort settings.

1. Complete the setup online at the owner website or using FordPass.

**Note:** *You should have been invited to complete the setup via email invitation when you ordered your vehicle. You can also add your VIN to FordPass Garage and see a remote vehicle setup option show up allowing you access to the same setup.*

2. Send your profile to the vehicle using your device.

**Note:** *You must complete the setup within 10 days of your profile downloading to your vehicle or it will be automatically deleted.*

3. Switch the vehicle on and make sure the transmission is in park (P).
4. When the welcome screen appears, follow the instructions on the display.

**Note:** *Do not navigate away while the profile is being saved.*



If you navigate away from the welcome screen instructions, press the RVS button in the status bar to restart from step 4.

**Note:** *After the remote vehicle setup profile is applied in-vehicle, the feature deactivates until a master reset occurs.*

## LINKING OR UNLINKING A PERSONAL PROFILE TO A REMOTE CONTROL

You can save preset memory positions for up to three remote controls by assigning a remote control to a personal profile using the touchscreen.

Use the touchscreen to link a remote control to a personal profile.

1. Switch the vehicle on and leave the vehicle in park (P).
2. Select the Personal Profiles button under Settings.
3. Touch the arrow for the profile you wish to link to a remote control.
4. Select remote control.
5. Follow the instructions on the display.

**Note:** *If more than one linked remote control is in range, the memory function moves to the settings of the first key to initiate a memory recall.*

**Note:** *The guest profile consists of existing settings when there is no driver profile created. After you create a driver profile, the guest profile serves as an additional driver profile.*

**Note:** *You cannot link a remote control to a guest profile.*

# Personal Profiles

---

## LINKING OR UNLINKING A PERSONAL PROFILE TO A DEVICE

Use the touchscreen to link a mobile device to a personal profile.

1. Switch the vehicle on and leave the vehicle in park (P).
2. Select the Personal Profiles button under Settings.
3. Touch the arrow for the profile you wish to link to a mobile device.
4. Select mobile device.
5. Follow the instructions on the display.

**Note:** *To successfully link a mobile device, the mobile device must be in your vehicle, and must have previously been setup as a remote control for your vehicle.*

**Note:** *The guest profile consists of existing settings when there is no driver profile created. After you create a driver profile, the guest profile serves as an additional driver profile.*

**Note:** *You cannot link a personalized name to a guest profile.*

## PERSONAL PROFILE SETTINGS

### Switching Intelligent Suggestions On and Off

Based on your usage patterns stored on your vehicle, Intelligent Suggestions is a feature that allows your vehicle to assist in your daily drive by providing phone calls, radio stations, navigation destinations, and charging stations as suggestions. These suggestions appear in the form of actionable buttons in the application drawer that you can press to complete that action.

1. Access the vehicle drawer on the touchscreen.
2. Press General.
3. Switch Intelligent Suggestions on or off.

## Navigation - Vehicles With: 12.3 Inch Screen

### CONNECTED NAVIGATION (IF EQUIPPED)

Your vehicle may be equipped with connected navigation. Depending on your version, you are given a 90 day or 3 year trial. After the trial period, you need to sign up to continue the experience. For additional information, visit [ford.com/connectedservices](http://ford.com/connectedservices).

**Note:** *If you do not sign up or renew your subscription, you can still use navigation through a connected device.*

### ACCESSING NAVIGATION



Press the button to access Navigation.

**Note:** *As the driver, be aware of all local traffic regulations and road attributes, and operate your vehicle in a safe and legal manner.*

### NAVIGATION MAP UPDATES

To update your Map data over Wi-Fi, your vehicle must be connected to a Wi-Fi access point. For USB updates and other details, contact dealers at 1-866-462-8837 in the United States and Canada, or 01-800-557-5539 in Mexico.

**Note:** *If you find map data errors, you may report them by going to [www.here.com/mapcreator](http://www.here.com/mapcreator).*

### ADJUSTING THE MAP

#### ZOOMING THE MAP IN AND OUT

You can use pinch gestures to zoom in and out. Place two fingers on the screen and move them apart to zoom in. Place two fingers on the screen and bring them together to zoom out.

#### CHANGING THE FORMAT OF THE MAP



Press the Menu button.

1. Press the Map Orientation tile.
2. Select a map orientation.

#### LIVE TRAFFIC

##### WHAT IS LIVE TRAFFIC

You can observe real-time road congestion when live traffic is on.

##### SWITCHING LIVE TRAFFIC ON AND OFF



Press the Menu button.

1. Press the Traffic on Map tile.
2. Press Traffic on or Traffic Off.

#### SETTING A DESTINATION

##### SETTING A DESTINATION USING THE TEXT ENTRY SCREEN

1. Press the search bar at the top of the screen.

## Navigation - Vehicles With: 12.3 Inch Screen

2. Enter your destination using the keyboard.
3. Press Search.
4. Select a destination from the list.
5. Press Start to begin navigation.

### SETTING A DESTINATION USING THE MAP SCREEN

Press and hold on the map to place a pin at that location. Information about the location of the pin appears on the screen.



Press the button to begin navigation to the pin.

### SETTING A DESTINATION USING TRIP PLANNER

The trip planner helps you create trips that take into consideration your current battery state of charge and identifies charging points along your route.

**Note:** *When you have a trailer attached, the trip planner can take the trailer into consideration and alter your trip as needed.*

### Using FordPass

#### Loading a Trip

You can create a trip using the FordPass app and import it to your vehicle. To load an imported trip:

1. Press the search bar at the top of the screen.
2. Press **MyTrips**.
3. Press **FordPass Trips**.
4. Select the trip you prefer.
5. Press **Go**.

**Note:** *You can press **Details** to see specific information about your route.*

### Using the Center Display

You can create, save and load trips outside of FordPass using the center display.

#### Creating a Trip

1. Press the search bar at the top of the screen.
  2. Press **MyTrips**.
  3. Press **+**.
  4. Enter your destination using the keyboard.
- Note:** *You can add multiple destinations to your trip.*
5. Press **Go**.

**Note:** *You can press **Details** to see specific information about your route.*

**Note:** *Trips created in the vehicle cannot be saved to FordPass.*

#### Saving a Trip

1. Press the search bar at the top of the screen.
2. Press **MyTrips**.
3. Press **+**.
4. Enter your destination using the keyboard.

**Note:** *You can add multiple destinations to your trip.*

5. Press **Save**.

#### Loading a Trip

To load a saved trip:

1. Press the search bar at the top of the screen.
2. Press **MyTrips**.
3. Select the saved trip to load.

**Note:** *You can press **Details** to see specific information about your route.*

# Navigation - Vehicles With: 12.3 Inch Screen

## SETTING A DESTINATION USING A PREDICTIVE DESTINATION

Press the predicted destination card on the screen to navigate to it. These appear when the navigation system has learned your driving habits.

## SETTING A DESTINATION USING A RECENT DESTINATION



Press the button.

Press a destination from the list.

**Note:** You can also use the search button to view recent destinations.

## SETTING A DESTINATION USING A SAVED DESTINATION

Press the star icon next when viewing location details to save the location.



Press the button.

Press a destination from the list.

**Note:** You can also use the search button to view saved destinations.

## SETTING A DESTINATION USING A POINT OF INTEREST

Press a point of interest icon on the map. Information about the location of the point of interest appears on the screen.



Press the button to begin navigation to the point of interest.

**Note:** You can also use the search button to view points of interest.

## WAYPOINTS

### ADDING A WAYPOINT



Press the Add Waypoint button when in an active navigation session.

1. Enter your waypoint on the keyboard.
2. Press Search.
3. Select a waypoint from the list.
4. Press Add to Trip.

### EDITING WAYPOINTS

1. Press the waypoint you would like to edit.
2. Select an option to reorder or delete the waypoint.

## ROUTE GUIDANCE

### ADJUSTING THE GUIDANCE PROMPT VOLUME

Turn the volume control when a guidance prompt plays to adjust the volume.

### REPEATING AN INSTRUCTION

Press the turn indicator to hear the last voice instruction.

### CANCELING ROUTE GUIDANCE



Press the button to cancel route guidance to the selected location.

## TRAILER TOWING NAVIGATION

When you have an active subscription and Trailer Towing Navigation is switched on, the system will calculate the best route for trailer towing by avoiding dangerous road conditions based on the dimensions of your trailer.

### Switching Trailer Towing Navigation On and Off

1. Press the **Navigation** button on the feature bar.
2. Press the **Menu** button.
3. Press **Trailer Routing**.
4. Switch **Trailer-optimized Routing** on or off.

### Entering Trailer Dimensions

1. Press the **Navigation** button on the feature bar.
2. Press the **Menu** button.
3. Press **Trailer Routing**.
4. Press **Towing Menu**.
5. Press **Add Trailer**.
6. Follow the instructions on the screen to enter the type and dimensions of the trailer into the system.

### Navigation Alerts

Alerts will appear on the navigation map while driving. An orange alert triangle indicates you should proceed with caution. When not following active guidance to a destination, a red alert triangle may appear and indicates you should avoid the road and find a detour.



# Navigation - Vehicles With: 15 Inch Screen

## CONNECTED NAVIGATION (IF EQUIPPED)

Your vehicle may be equipped with connected navigation. Depending on your version, you are given a 90 day or 3 year trial. After the trial period, you need to sign up to continue the experience. For additional information, visit [ford.com/connectedservices](http://ford.com/connectedservices).

**Note:** *If you do not sign up or renew your subscription, you can still use navigation through a connected device.*

## ACCESSING NAVIGATION

1. Access the application drawer on the touchscreen.
2. Press the navigation button.

**Note:** *As the driver, be aware of all local traffic regulations and road attributes, and operate your vehicle in a safe and legal manner.*

## NAVIGATION MAP UPDATES

To update your Map data over Wi-Fi, your vehicle must be connected to a Wi-Fi access point. For USB updates and other details, contact dealers at 1-866-462-8837 in the United States and Canada, or 01-800-557-5539 in Mexico.

**Note:** *If you find map data errors, you may report them by going to [www.here.com/mapcreator](http://www.here.com/mapcreator).*

## ADJUSTING THE MAP

### ZOOMING THE MAP IN AND OUT

You can use pinch gestures to zoom in and out. Place two fingers on the screen and move them apart to zoom in. Place two fingers on the screen and bring them together to zoom out.

### CHANGING THE FORMAT OF THE MAP



Press the map format button on the left side of the map screen to toggle between the available formats.

## LIVE TRAFFIC

### WHAT IS LIVE TRAFFIC

You can observe real-time road congestion when live traffic is on.

### SWITCHING LIVE TRAFFIC ON AND OFF

1. Press the tools button on the map screen.
2. Press Navigation Settings.
3. Press the Traffic button.
4. Switch Traffic on or off.

## SETTING A DESTINATION

### SETTING A DESTINATION USING THE TEXT ENTRY SCREEN

1. Press the search bar at the top of the screen.
2. Enter your destination using the keyboard.

# Navigation - Vehicles With: 15 Inch Screen

3. Select a destination from the list.
4. Press Go! to begin navigation.

## SETTING A DESTINATION USING THE MAP SCREEN

Press on the map to trigger the roaming and viewing screen. Press on the map again to place a pin at that location. Information about the location of the pin appears on the screen. Press the Go! button to begin navigation to the pin.

## SETTING A DESTINATION USING TRIP PLANNER

The trip planner helps you create trips that take into consideration your current battery state of charge and identifies charging points along your route.

**Note:** *When you have a trailer attached, the trip planner can take the trailer into consideration and alter your trip as needed.*

## Using FordPass

### Loading a Trip

You can create a trip using the FordPass app and import it to your vehicle. To load an imported trip:

1. Press the search bar at the top of the screen.
2. Press **MyTrips**.
3. Press **FordPass Trips**.
4. Select the trip you prefer.
5. Press **Go**.

**Note:** *You can press **Details** to see specific information about your route.*

### Using the Center Display

You can create, save and load trips outside of FordPass using the center display.

## Creating a Trip

1. Press the search bar at the top of the screen.
2. Press **MyTrips**.
3. Press **+**.
4. Enter your destination using the keyboard.

**Note:** *You can add multiple destinations to your trip.*

5. Press **Go**.

**Note:** *You can press **Details** to see specific information about your route.*

**Note:** *Trips created in the vehicle cannot be saved to FordPass.*

## Saving a Trip

1. Press the search bar at the top of the screen.
2. Press **MyTrips**.
3. Press **+**.
4. Enter your destination using the keyboard.

**Note:** *You can add multiple destinations to your trip.*

5. Press **Save**.

## Loading a Trip

To load a saved trip:

1. Press the search bar at the top of the screen.
2. Press **MyTrips**.
3. Select the saved trip to load.

**Note:** *You can press **Details** to see specific information about your route.*

# Navigation - Vehicles With: 15 Inch Screen

---

## SETTING A DESTINATION USING A PREDICTIVE DESTINATION

### Switching Predictive Destinations On and Off

You can switch Destination Suggestions on and off under the User Data section in the navigation settings menu.

### Setting a Destination

Access the feature bar using the touchscreen and select the predicted destination at the top of the screen. You can access additional predictive destinations by pressing the search bar on the map screen and then pressing the myTrends button.

## SETTING A DESTINATION USING A RECENT DESTINATION

1. Press the search bar on the map screen.
2. Press Recents.
3. Select a destination from the list.

## SETTING A DESTINATION USING A SAVED DESTINATION

1. Press the search bar.
2. Press favorites.
3. Select a saved destination.

**Note:** Press the star icon next when viewing location details to save the location.

## SETTING A DESTINATION USING A POINT OF INTEREST

Press on a point of interest icon on the map. Information about the location of the point of interest appears on the screen. Press the Go! button to begin navigation to the point of interest.

## WAYPOINTS

### ADDING A WAYPOINT

1. Begin navigation to a destination.
2. Search for your waypoint using the search bar.
3. Press Go!
4. Press Add to add the waypoint to your trip.

### EDITING WAYPOINTS

1. Press the search bar on the map screen.
2. Press myTrips.
3. Press Current Trip.
4. Use the menu to add destinations, remove destinations, or rearrange destinations.

## ROUTE GUIDANCE

### ADJUSTING THE GUIDANCE PROMPT VOLUME

Turn the volume control when a guidance prompt plays to adjust the volume.

### REPEATING AN INSTRUCTION

Press the turn indicator to hear the last voice instruction.

### CANCELING ROUTE GUIDANCE



Press the button to cancel route guidance to the selected location.

## TRAILER TOWING NAVIGATION

When you have an active subscription and Trailer Towing Navigation is switched on, the system will calculate the best route for trailer towing by avoiding dangerous road conditions based on the dimensions of your trailer.

### Switching Trailer Towing Navigation On and Off

1. Access the application drawer on the touchscreen.
2. Press the **Navigation** button.
3. Press the **Menu** button.
4. Press **Trailer Routing**.
5. Switch **Trailer-optimized Routing** on or off.

### Entering Trailer Dimensions

1. Access the application drawer on the touchscreen.
2. Press the **Navigation** button.
3. Press the **Menu** button.
4. Press **Trailer Routing**.
5. Press **Towing Menu**.
6. Press **Add Trailer**.
7. Follow the instructions on the screen to enter the type and dimensions of the trailer into the system.

### Navigation Alerts

Alerts will appear on the navigation map while driving. An orange alert triangle indicates you should proceed with caution. When not following active guidance to a destination, a red alert triangle may appear and indicates you should avoid the road and find a detour.

## Driver Identification (If Equipped)

---

### HOW DOES DRIVER IDENTIFICATION WORK

Driver identification allows drivers to log into the vehicle using a specific user ID or profile.

### SIGNING IN AS A DRIVER

1. Press **Features** on the touchscreen.

2. Press **Driver ID**.
3. Select or add a driver as necessary.
4. Follow the screen instructions and log in.

### Configuring Your Driver ID Avatar

1. Log in with your user ID.
2. Press your avatar image.
3. Select the settings you prefer.

## DRIVER IDENTIFICATION – TROUBLESHOOTING

### DRIVER IDENTIFICATION – INFORMATION MESSAGES

Message	Details
Driver not found.	The user ID used is not found in database.
Wrong PIN or password	The wrong PIN or password was entered.
Driver authentication time out. Unable to establish connection to the cloud.	When logging in, the vehicle is not able to establish a connection to the cloud.
Unable to connect to cloud. Try again.	The vehicle is not able to establish a connection to the cloud.

# Vehicle System Updates - Vehicles With: 12.3 Inch Screen

## UPDATING THE VEHICLE SYSTEMS WIRELESSLY



Over the air system updates allow you to update your vehicle system software wirelessly. To make sure you receive all updates, set a recurring schedule and connect to Wi-Fi. Updates may take longer if not connected to Wi-Fi, or may not download at all. See **Connected Vehicle** (page 485).

### Over the Air System Update Requirements

Before updating, reference this list to make sure your vehicle is ready to be updated. If these requirements are not met during a scheduled update, the update will be canceled and you can reschedule.

- Your vehicle is not running.
- Your vehicle is stopped.
- Your vehicle is parked.
- The hazard indicators are switched off.
- The alarm is not sounding.
- The doors are closed.
- The parking lights are switched off.
- You are not pressing the brake pedal.
- An emergency call is not in progress.
- Your vehicle is not in limp mode.

### Enabling Over the Air Updates

1. Press **Settings** on the touchscreen.
2. Press **Software Update**.
3. Switch **Automatic Updates** on or off.

**Note:** Over the air updates are enabled by default.

**Note:** If you do not want to receive over the air updates you can turn them off. You will not be notified of new updates.

### Scheduling an Update

Scheduling an update allows you to set a convenient time for the update to complete. We recommend updating overnight when your vehicle is not in use. Ensure Vehicle Connectivity and Automatic Updates are enabled. Once you complete these steps, your schedule will be saved for future updates. As long as an update is not in process you can adjust your schedule.

**Note:** Some updates may be applied outside of your set schedule. Information about the unscheduled update appears on the touchscreen after it is applied.

### Using the Settings Menu

1. Press **Settings** on the touchscreen.
2. Press **Software Update**.
3. Press **Schedule Updates**.
4. Use the controls to set the time and day of the update.
5. Save the schedule.

**Note:** You can set the updates to occur at any time.

### Using the Status Bar Icon



When an update is available, tap the notification icon and follow the prompts on the screen.

### Applying an Over the Air Update

You can see the progress of the update on the touchscreen. An update cannot be canceled once it has been started.

# Vehicle System Updates - Vehicles With: 12.3 Inch Screen

---

During an update you will not be able to drive your vehicle, start the vehicle, use remote controls to lock and unlock the vehicle. The alarm, central locks, and door tones are disabled. The electronic door lock will not function during an update. You can open the doors using the mechanical latch if child locks are not on. Pull the handle until it stops to use the mechanical latch. Some updates may not allow you to use your vehicle during the update process.

**Note:** *Some updates can complete in the background, but more complex updates can take up to 45 minutes.*

**Note:** *Double locking is switched off and central locking is switched on during and after an update.*

**Note:** *If your vehicle is plugged in, charging will stop during an update and resume when the update is complete.*

## Viewing Update Details

If an update is successful, the touchscreen will provide additional details about the update. You can also access this information under the System Update tile.

If an update is not successful, follow the prompt that appears on the touchscreen.

## PERFORMING A MASTER RESET



Press the settings option on the feature bar.

1. Press **General**.
2. Press **Reset**.
3. Press **Master Reset**.
4. Follow the prompts on the screen to complete the reset.

# Vehicle System Updates - Vehicles With: 15 Inch Screen

## UPDATING THE VEHICLE SYSTEMS WIRELESSLY



Over the air system updates allow wireless updates to the vehicle's system software. To make sure you receive all updates, set a recurring schedule and connect to Wi-Fi. Updates may take longer if not connected to Wi-Fi, or may not download at all. See **Connected Vehicle** (page 485).

**Note:** Additional over the air update icons may appear in the status bar. See **Status Bar** (page 516).

### Over the Air System Update Requirements

Before updating, refer to the following list to make sure your vehicle is ready to be updated. If all of the following requirements are not met during a scheduled update, the update cancels and you can reschedule.

- Your vehicle is not running.
- Your vehicle is stopped.
- Your vehicle is parked.
- The hazard indicators are switched off.
- The alarm is not sounding.
- The doors are closed.
- The parking lights are switched off.
- You are not pressing the brake pedal.
- An emergency call is not in progress.
- Your vehicle is not in limp home mode.

### Scheduling an Over the Air System Update

Make sure vehicle connectivity and automatic updates are switched on.

#### Using the Settings Menu

1. Access the vehicle drawer on the touchscreen.

2. Press **SETTINGS**.
3. Press **System Updates**.
4. Press **Schedule Updates**.
5. Use the controls to set the time and day of the update.
6. Save the schedule.

**Note:** You can set the updates to occur every seven days.

#### Using the Status Bar Icon



When an update is available, tap the notification icon and follow the prompts on the screen.

### Applying an Over the Air System Update

You can schedule a convenient time for the update to complete. During scheduled updates you may not be able to use your vehicle.

**Note:** Updates may take up to 30 minutes to complete.

You can see the progress of the update on the touchscreen. An update cannot be canceled once it has been started.

When applying updates:

- You cannot drive your vehicle.
- You cannot start your vehicle.
- You cannot use the remote control to lock and unlock your vehicle.
- The alarm, central locks and door tones turn off.
- The electronic door locks turn off.

You can open the doors using the mechanical latch if child locks are not on. Pull the handle until it stops to use the mechanical latch.

**Note:** Double locking is switched off and central locking is switched on during and after an update.



# Vehicle System Updates - Vehicles With: 15 Inch Screen

---

**Note:** *If your vehicle is plugged in, charging stops during an update and resumes when the update is complete.*

## Viewing Update Details

Upon completion of the update, the touchscreen provides additional details about the update. You can also access this information under the System Update tile.

If an update is not successful, follow the prompt on the touchscreen.

## PERFORMING A MASTER RESET

1. Access the vehicle drawer.
2. Press **SETTINGS**.
3. Press **General**.
4. Press **Reset**.
5. Press **Master Reset**.
6. Follow the prompts on the screen to complete the reset.

# Accessories

For a complete listing of the accessories that are available for your vehicle, please contact your authorized dealer or visit the online store web site:

<b>Web Address (United States)</b>
------------------------------------

<a href="http://www.Accessories.Ford.com">www.Accessories.Ford.com</a>
--

<b>Web Address (Canada)</b>
-----------------------------

<a href="http://www.Accessories.Ford.ca">www.Accessories.Ford.ca</a>
--

We will repair or replace any properly authorized dealer-installed Ford Original Accessory found to be defective in factory-supplied materials or workmanship during the warranty period, as well as any component damaged by the defective accessories.

We will warrant your Ford Original Accessory through the warranty that provides the greatest benefit:

- 24 months, unlimited mileage.
- The remainder of your new vehicle limited warranty.

Contact an authorized dealer for details and a copy of the warranty.

Ford Licensed Accessories are the accessory manufacturer's designs. The manufacturer develops and therefore warrants Ford Licensed Accessories, and does not design or test these accessories to Ford Motor Company engineering requirements. Contact an authorized Ford dealer for the manufacturer's limited warranty details, and request a copy of the Ford Licensed Accessories product limited warranty from the accessory manufacturer.

For maximum vehicle performance, keep the following information in mind when adding accessories or equipment to your vehicle:

- When adding accessories, equipment, passengers and luggage to your vehicle, do not exceed the total weight capacity of the vehicle or of the front or rear axle (GVWR or GAWR as indicated on the Safety Compliance Certification label). Ask an authorized dealer for specific weight information.
- The Federal Communications Commission (FCC) and Canadian Radio Telecommunications Commission (CRTC) regulate the use of mobile communications systems that are equipped with radio transmitters, for example two-way radios, telephones and theft alarms. Any such equipment installed in your vehicle should comply with Federal Communications Commission (FCC) and Canadian Radio Telecommunications Commission (CRTC) regulations and should be installed only by an authorized dealer.
- An authorized dealer needs to install mobile communications systems. Improper installation may harm the operation of your vehicle, particularly if the manufacturer did not design the mobile communication system specifically for automotive use.
- If you or an authorized Ford dealer add any non-Ford electrical or electronic accessories or components to your vehicle, you may adversely affect battery performance and durability. In addition, you may also adversely affect the performance of other electrical systems in the vehicle.

# Ford Protect

---

## WHAT IS FORD PROTECT

Protect yourself from the rising cost of vehicle repairs with a Ford Protect extended service plan.

### Ford Protect Extended Service Plans - United States Only

Ford Protect extended service plans mean peace of mind. Extended service plans are backed by Ford Motor Company, and provide more protection beyond the New Vehicle Limited Warranty coverage. When you visit your Ford Dealer, insist on the Ford Protect extended service plan.

### Ford Protect Can Quickly Pay for Itself

One trip to the service center could easily exceed the price of your Ford Protect extended service plan. With the Ford Protect extended service plan, you minimize your risk for unexpected repair bills and rising repair costs.

### Up to 1,000+ Covered Vehicle Components

There are four mechanical Ford Protect extended service plans with different levels of coverage. Ask your authorized dealer for details.

1. PremiumCARE - Our most comprehensive coverage. With over 1,000 covered components, this plan is so complete it is probably easier to list what is not covered.
2. ExtraCARE - Covers 113 components, and includes many high-tech items.
3. BaseCARE - Covers 84 components.

Ford Protect extended service plans are honored by all authorized Ford dealers in the United States, Canada and Mexico.

That means you get:

- Reliable, quality service at any Ford or Lincoln dealership.
- Repairs performed by factory trained technicians, using genuine parts.

### Rental Car Reimbursement

#### *First Day Rental Benefit*

If you bring your car into your dealer for service, we will give you a rental vehicle to use for the day.

#### *Extended Rental Benefits*

If your vehicle is kept overnight for covered repairs, you are eligible for rental car coverage, warranty repairs, and field service actions.

### Roadside Assistance

Exclusive 24/7 roadside assistance, including:

- Towing, flat-tire change and battery jump starts.
- Out of fuel and lock-out assistance.
- Travel expense reimbursement for lodging, meals and rental car.
- Assistance for taxi, shuttle, rental car coverage or other transportation.

### Transferable Coverage

If you sell your vehicle before your Ford Protect extended service plan coverage expires, you can transfer any remaining coverage to the new owner. This should give you and your potential buyer peace of mind.

# Ford Protect

---

## Less Cost to Properly Maintain Your Vehicle

The Ford Protect extended service plan also offers a Premium Maintenance Plan that covers all scheduled maintenance, and selected wear items. The coverage is prepaid, so you never have to worry about the cost of your vehicle's maintenance.

Covered maintenance includes:

- Windshield wiper blades.
- Spark plugs.
- The clutch disc (if equipped).
- Brake pads and linings.
- Shock absorbers.
- Struts.
- Engine belts.
- Engine coolant hoses, clamps and o-rings.
- Diesel exhaust fluid replenishment (if equipped).
- Cabin air filter replacement every 20,000 mi (32,000 km) for electric vehicles only.

## Interest Free Finance Options

Just a 5% down payment provides you with an affordable, no interest, no fee payment program allowing you all the security and benefits Ford Protect extended service plan has to offer while paying over time. You are pre-approved with no credit check or hassles. To learn more, call our Ford Protect extended service plan specialists at 800-367-3377.

Ford Protect Extended Service Plan  
P.O. Box 321067  
Detroit, MI 48232

## Ford Protect Extended Service Plan (Canada Only)

You can get more protection for your vehicle by purchasing a Ford Protect extended service plan. Ford Protect extended service plan is the only service contract backed by Ford Motor Company of Canada, Limited. Depending on the plan you purchase, Ford Protect extended service plan provides benefits such as:

- Rental reimbursement.
- Coverage for certain maintenance and wear items.
- Protection against repair costs after your New Vehicle Limited Warranty Coverage expires.
- Roadside Assistance benefits.

There are several Ford Protect extended service plans available in various time, distance and deductible combinations. Each plan is tailored to fit your own driving needs, including reimbursement for towing and rental. When you purchase Ford Protect extended service plan, you receive added peace-of-mind protection throughout Canada, the United States and Mexico, provided by a network of participating authorized Ford Motor Company dealers.

**Note:** *Repairs performed outside of Canada and the United States are not eligible for Ford Protect extended service plan coverage.*

This information is subject to change. Visit your local Ford of Canada dealer or [www.ford.ca](http://www.ford.ca) to find the Ford Protect extended service plan that is right for you.

# Scheduled Maintenance

---

## GENERAL MAINTENANCE INFORMATION

### Why Maintain Your Vehicle?

Carefully following the maintenance schedule helps protect against major repair expenses resulting from neglect or inadequate maintenance and may help to increase the value of your vehicle when you sell or trade it. Keep all receipts for completed maintenance with your vehicle.

It is important that you have your vehicle serviced at the proper times. These intervals serve two purposes; first is to maintain the reliability of your vehicle and the second is to keep the cost of owning your vehicle down.

It is your responsibility to have all scheduled maintenance performed and to make sure that the materials used meet the specifications identified in this owner's manual. See **Capacities and Specifications** (page 480).

Failure to perform scheduled maintenance and regularly inspect your vehicle may result in vehicle damage not covered by the vehicle Warranty.

### Why Maintain Your Vehicle at Your Dealership?

#### Our Genuine Replacement Parts

Dealerships stock our parts and our authorized branded re-manufactured replacement parts. These parts meet or exceed our specifications. Parts installed at your dealership carry a nationwide 24-month or unlimited mile (kilometer) parts and labor limited warranty.

If you do not use our authorized parts they may not meet our specifications.

### Protecting Your Investment

Maintenance is an investment that pays dividends in the form of improved reliability, durability and resale value. To maintain the proper performance of your vehicle, make sure you have scheduled maintenance performed at the designated intervals.

It is important to rely upon your dealership to properly diagnose and repair your vehicle.

We have recommended maintenance intervals for various parts and component systems based upon engineering testing. We rely upon this testing to determine the most appropriate mileage for replacement of fluids to protect your vehicle at the lowest overall cost to you and recommends against maintenance schedules that deviate from the scheduled maintenance information.

We strongly recommend the use of only our genuine manufactured or our authorized re-manufactured replacement parts engineered for your vehicle.

#### Additives and Chemicals

We do not recommend using chemicals or additives not approved by us as part of your vehicle's normal maintenance. Please consult your warranty information.

#### Fluids and Flushing

In many cases, fluid discoloration is a normal operating characteristic and, by itself, does not necessarily indicate a concern or that the fluid needs to be changed. However, a qualified expert, such as the factory-trained technicians at your dealership, should inspect discolored fluids that also show signs of overheating or foreign material contamination immediately.

# Scheduled Maintenance

Make sure to change your vehicle's fluids at the specified intervals or in conjunction with a repair. Flushing is a viable way to change fluid for many vehicle sub-systems during scheduled maintenance. It is critical that systems are flushed only with new fluid that is the same as that required to

fill and operate the system or using our approved flushing chemical.

## Owner Checks and Services

Make sure you perform the following basic maintenance checks and inspections every month or at six-month intervals.

<b>Check Every Month</b>
Function of all interior and exterior lights.
Tires (including spare) for wear and proper pressure.
Windshield washer fluid level.

<b>Check Every Six Months</b>
12V Battery connections. Clean if necessary.
Body and door drain holes for obstructions. Clean if necessary.
Cooling system fluid level and coolant strength.
Door weatherstrips for wear. Lubricate if necessary.
Hinges, latches and outside locks for proper operation. Lubricate if necessary.
Parking brake for proper operation.
Safety belts and seat latches for wear and function.
Safety warning lamps (brake, ABS, airbag and safety belt) for operation.
Washer spray and wiper operation. Clean or replace blades as necessary.

## Multi-point Inspection

In order to keep your vehicle running right, it is important to have the systems on your vehicle checked regularly. This can help identify potential issues and prevent major problems. We recommend having the following multi-point inspection performed at every scheduled maintenance interval to help make sure your vehicle keeps running great.

# Scheduled Maintenance

Multi-Point Inspection	
12V Battery performance	Radiator, cooler, heater and air conditioning hoses
Exterior lamps and hazard warning system operation	Suspension components for leaks or damage
Fluid levels; fill if necessary <sup>1</sup>	Steering and linkage
For fluid leaks	Tires for wear and proper pressure <sup>2</sup>
Half-shaft dust boots	Windshield for cracks, chips or pits
Horn operation	Washer spray and wiper operation

<sup>1</sup> Brake, coolant recovery reservoir and window washer.

<sup>2</sup> Your vehicle is equipped with a temporary mobility kit; check the tire sealant expiration Use By date on the canister. Replace as needed.

Be sure to ask your dealership service advisor or technician about the multi-point vehicle inspection. It is a comprehensive way to perform a thorough inspection of your vehicle. Your checklist gives you immediate feedback on the overall condition of your vehicle.

## NORMAL SCHEDULED MAINTENANCE

Normal Scheduled Maintenance <sup>1</sup>	
Every 12 months or 10,000 mi (16,000 km).	Rotate the tires, inspect for tire wear and measure the tread depth.
	Perform a multi-point inspection (recommended).
	Inspect the brake pads, shoes, rotors, drums, brake linings, hoses and the parking brake.
	Inspect the cooling system coolant level, coolant strength, and the cooling system hoses.
	Inspect the halfshaft boots.

## Scheduled Maintenance

<b>Normal Scheduled Maintenance</b> <sup>1</sup>	
	Inspect the steering linkage, ball joints, suspension and tie-rod ends.
	Inspect the wheels and related components for abnormal noise, wear, looseness or drag.

<sup>1</sup> Do not exceed one year or 10,000 mi (16,000 km) between service intervals.

<b>Brake Fluid Maintenance</b> <sup>1</sup>	
Every 3 Years	Change brake fluid. <sup>2</sup>

<sup>1</sup> Perform this maintenance item every 3 years. Do not exceed the designated service interval.

<sup>2</sup> Brake fluid servicing requires special equipment available at your authorized dealer.

<b>Other Maintenance Items</b>	
At 10 years or 150,000 mi (240,000 km)	Change the transmission fluid.



# Customer Information

## ROLLOVER WARNING



**WARNING:** Utility vehicles have a significantly higher rollover rate than other types of vehicles.



**WARNING:** Vehicles with a higher center of gravity (utility and four-wheel drive vehicles) handle differently than vehicles with a lower center of gravity (passenger cars). Avoid sharp turns, excessive speed and abrupt steering in these vehicles. Failure to drive cautiously increases the risk of losing control of your vehicle, vehicle rollover, personal injury and death.



**WARNING:** In a rollover crash, an unbelted person is significantly more likely to die than a person wearing a seatbelt.



**WARNING:** Do not become overconfident in the ability of four-wheel drive vehicles. Although a four-wheel drive vehicle may accelerate better than a two-wheel drive vehicle in low traction situations, it won't stop any faster than two-wheel drive vehicles. Always drive at a safe speed.

Utility vehicles and trucks handle differently than passenger cars in the various driving conditions that are encountered on streets, highways and off-road. Utility vehicles and trucks are not designed for cornering at speeds as high as passenger cars any more than low-slung sports cars are designed to perform satisfactorily under off-road conditions.

## THE BETTER BUSINESS BUREAU AUTO LINE PROGRAM

Your satisfaction is important to Ford Motor Company and to your dealer. If a warranty concern has not been resolved using the three-step procedure outlined earlier in this chapter in the Getting the Services you need section, you may be eligible to participate in the BBB AUTO LINE program.

The BBB AUTO LINE program consists of two parts – mediation and arbitration. During mediation, a representative of the BBB will contact both you and Ford Motor Company to explore options for settlement of the claim. If an agreement is not reached during mediation or you do not want to participate in mediation, and if your claim is eligible, you may participate in the arbitration process. An arbitration hearing will be scheduled so that you can present your case in an informal setting before an impartial person. The arbitrator considers the testimony provided and makes a decision after the hearing.

Disputes submitted to the BBB AUTO LINE program are usually decided within 40 days after you file your claim with the BBB. You are not bound by the decision, and may reject the decision and proceed to court where all findings of the BBB Auto Line dispute, and decision, are admissible in the court action. Should you choose to accept the BBB AUTO LINE decision, Ford is then bound by the decision, and must comply with the decision within 30 days of receipt of your acceptance letter.

**BBB AUTO LINE Application:** Using the information that follows, please call or write to request a program application. You will be asked for your name and address, general information about your new vehicle, information about your warranty concerns, and any steps you have

## Customer Information

---

already taken to try to resolve them. A Customer Claim Form will be mailed that needs to be completed, signed and returned to the BBB along with proof of ownership. Upon receipt, the BBB reviews the claim for eligibility under the Program Summary Guidelines.

**You can get more information by calling BBB AUTO LINE at 1-800-955-5100, or writing to:**

**BBB AUTO LINE a Division of BBB National Programs, Inc.  
1676 International Drive, Suite 550  
McLean, VA 22102**

BBB AUTO LINE applications can also be requested by calling the Ford Motor Company Customer Relationship Center at 1-800-392-3673.

For additional information, refer to the Better Business Bureau website.

**Note:** *Ford Motor Company reserves the right to change eligibility limitations, modify procedures, or to discontinue this process at any time without notice and without obligation.*

### THE MEDIATION AND ARBITRATION PROGRAM

For vehicles delivered to authorized Canadian dealers. In those cases where you continue to feel that the efforts by Ford of Canada and the authorized dealer to resolve a factory-related vehicle service concern have been unsatisfactory, Ford of Canada participates in an impartial third party mediation/arbitration program administered by the Canadian Motor Vehicle Arbitration Plan (CAMVAP).

The CAMVAP program is a straightforward and relatively speedy alternative to resolve a disagreement when all other efforts to produce a settlement have failed. This procedure is without cost to you and is designed to eliminate the need for lengthy and expensive legal proceedings.

In the CAMVAP program, impartial third-party arbitrators conduct hearings at mutually convenient times and places in an informal environment. These impartial arbitrators review the positions of the parties, make decisions and, when appropriate, render awards to resolve disputes. CAMVAP decisions are fast, fair, and final as the arbitrator's award is binding on both you and Ford of Canada.

CAMVAP services are available in all Canadian territories and provinces. For more information, without charge or obligation, call your CAMVAP Provincial Administrator directly at 1-800-207-0685 or visit [www.camvap.ca](http://www.camvap.ca).

### ORDERING A CANADIAN FRENCH OWNER'S MANUAL

You can obtain a French owner's manual from an authorized dealer or by contacting Helm, LLC at:

HELM, LLC  
47911 Halyard Drive, Suite 200  
Plymouth, Michigan 48170  
Attention: Customer Service

Call toll free: 1-800-782-4356

Monday-Friday 8:00 a.m. - 6:00 p.m. EST

For additional information, visit [www.helminc.com](http://www.helminc.com).

## Customer Information

---

### REPORTING SAFETY DEFECTS IN THE UNITED STATES

If you believe that your vehicle has a defect which could cause a crash or could cause injury or death, you should immediately inform the National Highway Traffic Safety Administration (NHTSA) in addition to notifying Ford Motor Company.

If NHTSA receives similar complaints, it may open an investigation, and if it finds that a safety defect exists in a group of vehicles, it may order a recall and remedy campaign. However, NHTSA cannot become involved in individual problems between you, your dealer, or Ford Motor Company.

To contact NHTSA, you may call the Vehicle Safety Hotline toll-free at 1-888-327-4236 (TTY: 1-800-424-9153); go to [www.safercar.gov](http://www.safercar.gov); or write to:

Administrator  
1200 New Jersey Avenue,  
Southeast

Washington, D.C. 20590

You can also obtain other information about motor vehicle safety from [www.safercar.gov](http://www.safercar.gov).

### REPORTING SAFETY DEFECTS IN CANADA

If you believe that your vehicle has a defect which could cause a crash or could cause injury or death, you should immediately inform Transport Canada and Ford of Canada.

Transport Canada Contact Information	
Website (English)	<a href="http://tc.canada.ca/recalls">http://tc.canada.ca/recalls</a>
Website (French)	<a href="http://tc.canada.ca/rappels">http://tc.canada.ca/rappels</a>
Phone	1-800-333-0510

Ford of Canada Contact Information	
Website	<a href="http://www.ford.ca">www.ford.ca</a>
Phone	1-800-565-3673

# Customer Information

## RADIO FREQUENCY CERTIFICATION LABELS

### BLIND SPOT INFORMATION SYSTEM SENSORS

#### United States and Canada



**WARNING:** Changes or modifications not expressly approved by the party responsible for compliance could void the user's authority to operate the equipment. The term "IC:" before the radio certification number only signifies that Industry Canada technical specifications were met.

FCC ID: L2CF5TR

IC: 3432A-F5TR

This device complies with Part 15 of the FCC Rules and with Innovation, Science and Economic Development Canada's licence-exempt RSS(s). Operation is subject to the following two conditions:

1. This device may not cause harmful interference, and
2. This device must accept any interference received, including interference that may cause undesired operation.

## BODY CONTROL MODULE

### Argentina

**CNC** COMISIÓN NACIONAL  
DE COMUNICACIONES

CNC ID: H-23804

### Brazil

 **ANATEL**  
Agência Nacional de Telecomunicações  
08346-19-05297

### Ghana

NCA PRODUCT IDENTIFIER: ZRO-M8-7E3-281

# Customer Information

---

## Jamaica

This product has been Type Approved by Jamaica: SMA - M3NA2C766336.

## Paraguay



2019-01-I-000076

## Moldova



## Serbia



## Morocco

AGREE PAR L'ANRT MAROC  
Numéro d'agrément: MR 20148 ANRT 2019  
Date d'agrément: 19/06/2019

## Singapore

Complies with IMDA Standards

DA 00461

# Customer Information

## South Africa



## United States and Canada

**WARNING:** Changes or modifications not expressly approved by the party responsible for compliance could void the user's authority to operate the equipment. The term "IC:" before the radio certification number only signifies that Industry Canada technical specifications were met.

FCC ID: M3NA2C766336

IC: 7812A-A2C766336

This device complies with Part 15 of the FCC Rules and with Innovation, Science and Economic Development Canada's licence-exempt RSS(s). Operation is subject to the following two conditions:

1. This device may not cause harmful interference, and
2. This device must accept any interference received, including interference that may cause undesired operation.

## Ukraine



## Vietnam

## United Arab Emirates (U.A.E.)

**TRA REGISTERED No:** ER68566/19

**DEALER No:** DA37380/15

## United Kingdom



# Customer Information

---

## Zambia



## Europe Union EU

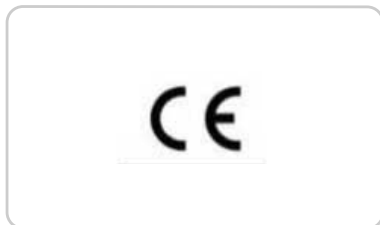

## CRUISE CONTROL MODULE

### Argentina



## Ghana

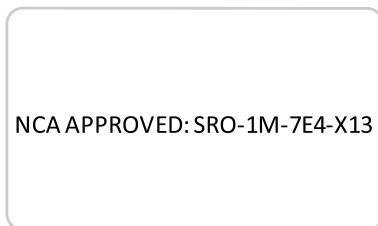

## Djibouti

AGREE PAR LE MCPT (REPUBLIQUE DE DJIBOUTI)

Numéro d'agrément : 059/DDTIC/2020

Date d'agrément : 01/10/2020

## Jamaica

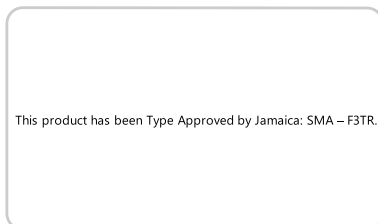

# Customer Information

## Mauritania

AGREE PAR L'ANE MAURITANIE  
Numéro d'agrément : 0835/ARE/2020  
Date d'agrément : 31/08/2020

## Taiwan



## Paraguay



## Unites Arab Emirates (U.A.E.)

TRA  
REGISTERED NO: ER80143/20  
DEALER NO: DA83047/19

2020-10-I-0752

## South Korea



## United States and Canada

 **WARNING:** Changes or modifications not expressly approved by the party responsible for compliance could void the user's authority to operate the equipment. The term "IC:" before the radio certification number only signifies that Industry Canada technical specifications were met.

FCC ID: L2CF3TR  
IC: 3432A-F3TR

R-C-1Ap-F3TR



## Customer Information

---

This device complies with Part 15 of the FCC Rules and with Innovation, Science and Economic Development Canada's licence-exempt RSS(s). Operation is subject to the following two conditions:

1. This device may not cause harmful interference, and
2. This device must accept any interference received, including interference that may cause undesired operation.

### Zambia



### KEYS AND REMOTE CONTROLS

#### Argentina



### Brazil



# Customer Information

## European Union EU

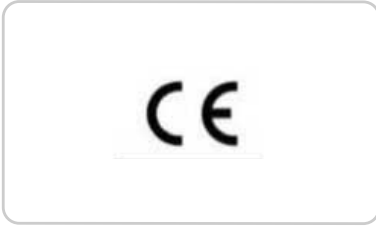

NR: 2016-9-I-000220

NR: 2016-9-I-000223

## Pakistan



## Jamaica

This product has been Type Approved by Jamaica: SMA – M3N-A2C931423



## Paraguay



NR: 2017-10-I-0000334

NR: 2018-07-I-000317

## Taiwan

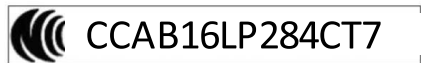

## Customer Information

---

 CCAB16LP284DT9

TRA  
REGISTERED No: ER47690/16  
DEALER No: DA37380/15

### United Arab Emirates (U.A.E.)

TRA  
REGISTERED No:  
ER37535/15

DEALER No:  
DA37380/15

TRA  
REGISTERED NO: ER46754/16  
DEALER NO: DA37380/15

TRA  
REGISTERED NO: ER49357/16  
DEALER NO: DA37380/15

### United States and Canada

 **WARNING:** Changes or modifications not expressly approved by the party responsible for compliance could void the user's authority to operate the equipment. The term "IC:" before the radio certification number only signifies that Industry Canada technical specifications were met.

FCC ID: M3N-A3C054338

FCC ID: M3N-A3C054339

FCC ID: N5F-A08TAA

FCC ID: N5F-A08TDA

FCC ID: M3N-A2C931423

FCC ID: M3N-A2C931426

# Customer Information

IC: 7812A-A3C054338

IC: 7812A-A3C054339

IC: 3248A-A08TAA

IC: 7812A-A2C931423

IC: 7812A-A2C931426

This device complies with Part 15 of the FCC Rules and with Innovation, Science and Economic Development Canada's licence-exempt RSS(s). Operation is subject to the following two conditions:

1. This device may not cause harmful interference, and
2. This device must accept any interference received, including interference that may cause undesired operation.

## PASSIVE ANTI-THEFT SYSTEM

### Argentina

CNC: H-20727

**CNC** COMISIÓN NACIONAL  
DE COMUNICACIONES

### Brazil



0106-14-03199

Este equipamento opera em caráter secundário, isto é, não tem direito a proteção contra interferência prejudicial, mesmo de estações do mesmo tipo, e não pode causar interferência a sistemas operando em caráter primário.

### Canada and United States of America



**WARNING:** Changes or modifications not expressly approved by the party responsible for compliance could void the user's authority to operate the equipment. The term "IC:" before the radio certification number only signifies that Industry Canada technical specifications were met.

FCC ID: OUC11545917

IC: 850K-11545917

This device complies with Part 15 of the FCC Rules and with Innovation, Science and Economic Development Canada's licence-exempt RSS(s). Operation is subject to the following two conditions:

1. This device may not cause harmful interference, and
2. This device must accept any interference received, including interference that may cause undesired operation.

# Customer Information

---

## Djibouti

AGREE PAR LE MCPT (REPUBLIQUE DE DJIBOUTI)  
Numéro d'agrément: 243/MCPT/SC/16  
Date d'agrément: 23/05/16

## Jamaica

This product has been Type Approved by Jamaica: SMA- OUC11545917

## Ghana

NCA APPROVED: NCA/TA/16/22

## Malaysia



CIDF18000209

## Indonesia

SERTIFIKAT NOMOR : 44714/SDPPI/2016  
PLG ID: 4941

## Mauritania

AGREE PAR L'ANE MAURITANIE  
Numéro d'agrément: 0231/ARE/2014  
Date d'agrément: 14/11/2014

# Customer Information

## Moldova



## Paraguay

NR: 2017-09-10000292



## Morocco

AGREE PAR L'ANRT MAROC  
Numéro d'agrément: MR 8922 ANRT 2014  
Date d'agrément: 04/02/2014

## Serbia



N011 16

## Pakistan

Pakistan Telecommunication Authority



Approved by PTA 2015

## Singapore

Complies with IMDA Standards

DA 00461

# Customer Information

---

## South Africa



## Taiwan, China

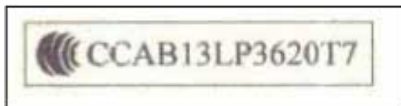

## South Korea



MSIP-RRM-OAC-OUC11541917

## Syria

SyTRA  
REGISTERED No:  
1510/4NK

## Ukraine



## United Arab Emirates (U.A.E.)

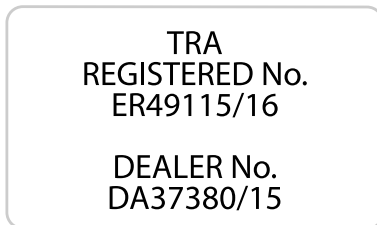

# Customer Information

## Vietnam



## RADIO TRANSCEIVER MODULE

### Argentina



### Brazil



## Djibouti

AGREE PAR LE MCPT (REPUBLIQUE DE DJIBOUTI)  
Numéros d'agrément : 033/DDTIC/2020  
Date d'agrément : 07/06/2020

AGREE PAR LE MCPT (REPUBLIQUE DE DJIBOUTI)  
Numéros d'agrément : 034/DDTIC/2020  
Date d'agrément : 07/06/2020

## Ghana

NCA APPROVED: SRO-1M-7E4-108

NCA APPROVED: SRO-1M-7E4-114

## Mauritania

AGREE PAR L'ANE MAURITANIE  
Numéro d'agrément: 0803/ARE/2020  
Date d'agrément: 03/06/2020



# Customer Information

---

## South Africa

AGREE PAR L'ANE MAURITANIE  
Numéro d'agrément : 0802/ARE/2020  
Date d'agrément : 03/06/2020



## Morocco

AGREE PAR L'ANE MAROC  
Numéro d'agrément : MR 24102 ANRT 2020  
Date d'agrément : 18/05/2020

## United Arab Emirates (U.A.E.)

TRA  
REGISTERED No:  
ER81341/20

DEALER No:  
DA88113/20

## Pakistan



TRA  
REGISTERED No:  
ER81342/20

DEALER No:  
DA88113/20

# Customer Information

## United States and Canada



**WARNING:** Changes or modifications not expressly approved by the party responsible for compliance could void the user's authority to operate the equipment. The term "IC:" before the radio certification number only signifies that Industry Canada technical specifications were met.

FCC ID: L2C0082R

FCC ID: L2C0083TR

IC: 342A-0083TR

This device complies with Part 15 of the FCC Rules and with Innovation, Science and Economic Development Canada's licence-exempt RSS(s). Operation is subject to the following two conditions:

1. This device may not cause harmful interference, and
2. This device must accept any interference received, including interference that may cause undesired operation.

## Zambia



## SYNC

### Argentina

CNC COMISIÓN NACIONAL  
DE COMUNICACIONES

CNC ID: C-24008

CNC COMISIÓN NACIONAL  
DE COMUNICACIONES

CNC ID: C-24009

## Brazil



08657-19-01505

**Este equipamento não tem direito à proteção contra interferência prejudicial e não pode causar interferência em sistemas devidamente autorizados.**

# Customer Information

---



08658-19-01505

**Este equipamento não tem direito à proteção  
contra interferência prejudicial e não pode causar  
interferência em sistemas devidamente autorizados.**

## European Union EU

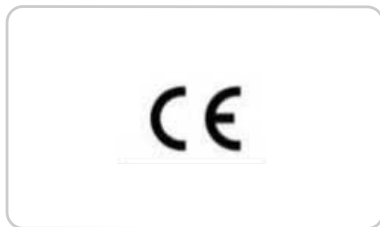

## Djibouti

AGREE PAR LE MCPT (REPUBLIQUE DE DJIBOUTI)

Numéro d'agrément : 124/DDTIC/2019

Date d'agrément : 07/08/2019

AGREE PAR LE MCPT (REPUBLIQUE DE DJIBOUTI)

Numéro d'agrément : 125/DDTIC/2019

Date d'agrément : 07/08/2019

## Ghana

NCA APPROVED: ZRO-1H-7E3-182

NCA APPROVED: ZRO-1H-7E3-180

## Jamaica

This product has been Type Approved by  
Jamaica: SMA – SYNC-G4.

# Customer Information

---

This product has been Type Approved by Jamaica: SMA – SYNC-G4L

AGREE PAR L'ANE MAURITANIE  
Numéro d'agrément : 0691/ARE/2018  
Date d'agrément : 08/08/2019

## Malaysia



SQASI/TA/19/4047

SQASI/TA/19/4046

## Mauritania

**AGREE PAR L'ANE MAURITANIE**  
**Numéro d'agrément : 0692/ARE/2018**  
**Date d'agrément : 08/08/2019**

## Moldova



## Morocco

AGREE PAR L'ANRT MAROC  
N° D'AGRÉMENT: MR 20608 ANRT 2019  
07 AOUT 2019

# Customer Information

---

## Serbia

AGREE PAR L'ANRT MAROC  
N° D'AGRÉMENT: MR 20606 ANRT 2019  
07 AOUT 2019



И005 20

## Pakistan



## Singapore

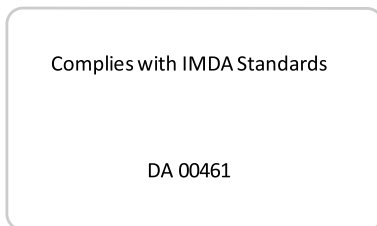

## Paraguay



## South Africa



2020-03-I-00192

2020-03-I-00193

# Customer Information

---



## South Korea



## Ukraine



## Taiwan

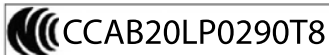

## United Arab Emirates (U.A.E.)



# Customer Information

## Zambia

TRA  
REGISTERED No: ER74903/19  
DEALER No: DA37380/15



## United States and Canada



**WARNING:** Changes or modifications not expressly approved by the party responsible for compliance could void the user's authority to operate the equipment. The term "IC:" before the radio certification number only signifies that Industry Canada technical specifications were met.

FCC ID: KMH-SYNCG4

FCC ID: KMH-SYNCG4L

IC: 1422A-SYNCG4

IC: 1422A-SYNCG4L

This device complies with Part 15 of the FCC Rules and with Innovation, Science and Economic Development Canada's licence-exempt RSS(s). Operation is subject to the following two conditions:

1. This device may not cause harmful interference, and
2. This device must accept any interference received, including interference that may cause undesired operation.



**TIRE PRESSURE MONITORING  
SYSTEM SENSORS - VEHICLES  
WITH: 315 MHZ SENSORS**

## Argentina

**CNC** COMISIÓN NACIONAL  
DE COMUNICACIONES

CNC ID: H-24068

# Customer Information

## Brazil



05160-16-08001

Este equipamento opera em caráter secundário, isto é, não tem direito a proteção contra interferência prejudicial, mesmo de estações do mesmo tipo, e não pode causar interferência a sistemas operando em caráter primário.

## Jamaica

This product has been Type Approved by Jamaica: SMA – FP3

## Mexico

IFT: RLVSCFP16-1400  
"La operación de este equipo está sujeta a las siguientes dos condiciones:  
(1) es posible que este equipo o dispositivo no cause interferencia perjudicial y  
(2) este equipo o dispositivo debe aceptar cualquier interferencia, incluyendo la que pueda causar su operación no deseada."

## Paraguay



## United States and Canada

**WARNING:** Changes or modifications not expressly approved by the party responsible for compliance could void the user's authority to operate the equipment. The term "IC:" before the radio certification number only signifies that Industry Canada technical specifications were met.

FCC ID: MRXFP3

IC: 2546A-FP3

This device complies with Part 15 of the FCC Rules and with Innovation, Science and Economic Development Canada's licence-exempt RSS(s). Operation is subject to the following two conditions:

1. This device may not cause harmful interference, and
2. This device must accept any interference received, including interference that may cause undesired operation.



# Customer Information

---

## TIRE PRESSURE MONITORING SYSTEM SENSORS - VEHICLES WITH: 433 MHZ SENSORS

### Argentina



### Djibouti



### China

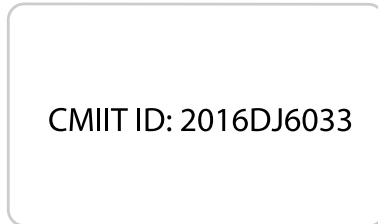

### Ghana

NCA APPROVED: 2R9-8M-7E0-0BE

### Jordan

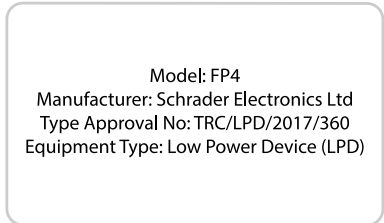

# Customer Information

## Mauritania

AGREE PAR L'ANE MAURITANIE  
Numéro d'agrément : 0358/ARE/2016  
Date d'agrément : 04/10/2016

## Oman

OMAN TRA  
TA-R/3591/16  
D080134

## Pakistan

Pakistan Telecommunication Authority



Approved by PTA 2016

## Moldova



## Paraguay



NR: 2018-07-I-000318

## Nigeria

Connection and use of this  
communications  
equipment is permitted by the Nigerian  
Communications Commission

# Customer Information

---

## Serbia



**M005 18**

## United Arab Emirates

TRA  
REGISTERED No:  
ER48598/16

DEALER No.  
DA0047074

## Singapore

Complies with  
IMDA Standards  
DA 107968

## WIRELESS ACCESSORY CHARGING MODULE

## Argentina

## South Korea



MSIP-CRM-SRD-FP4

**CNC** COMISIÓN NACIONAL  
DE COMUNICACIONES

CNC ID: H-21576

## Ukraine



**UA.TR.109**

**CNC** COMISIÓN NACIONAL  
DE COMUNICACIONES

CNCID: H-25997

# Customer Information

---

## Brazil



## European Union EU

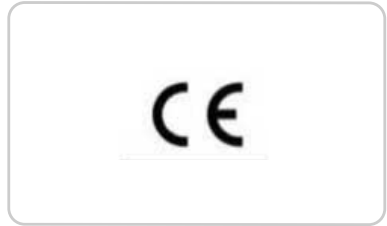

## Ghana

NCA APPROVED: 1R3-1M-7E1-174

## Djibouti



NCA APPROVED: 7ES-7M-110-RDR

## Jamaica

AGREE PAR LE MCPT (REPUBLIQUE DE DJIBOUTI)  
Numéro d'agrément : 133/DDTIC/2021  
Date d'agrément : 07/09/2021

This product has been Type Approved  
by Jamaica: SMA - WACM.

# Customer Information

---

## Mauritania

This product has been Type Approved By Jamaica:  
SMA – WACM3

AGREE PAR L'ANE MAURITANIE  
Numéro d'agrément : 0474/ARE/2018  
Date d'agrément : 05/03/2018

## Jordan

Type Approval No: TRC/LPD/2017/418  
Equipment Type: Low Power Device (LPD)

## Malaysia



SQASI/TA/19/4129  
SQASI/TA/21/3832

AGREE PAR L'ANE MAURITANIE  
Numéro d'agrément : 0964/ARE/2021  
Date d'agrément : 7/12/2021

## Moldova



# Customer Information

---

## Morocco

AGREE PAR L'ANRT MAROC  
Numéro d'agrément : MR 15474 ANRT 2017  
Date d'agrément : 25/12/2017

AGREE PAR L'ANRT MAROC  
Numéro d'agrément : MR 00029420 ANRT 2021  
Date d'agrément : 11/07/2021

## Paraguay



2017-10-I-0000333

2021-08-I-0489

## Russia



## Serbia



M011 18



M005 21

# Customer Information

---

## Singapore

Complies with IMDA Standards

DA 00461

## South Korea



R-RMM-DLH-WACM

## South Africa



## Taiwan

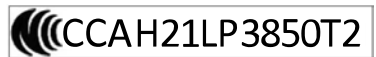
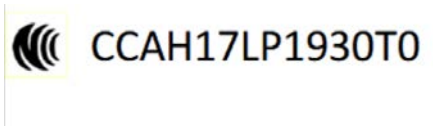

# Customer Information

## Ukraine



TRA  
REGISTERED No:  
ER98639/21  
  
DEALER No:  
DA37380/15

## United Arab Emirates (U.A.E.)

TRA  
REGISTERED No:  
ER57347/17  
  
DEALER No:  
DA37380/15

## United Kingdom



## United States and Canada

 **WARNING:** Changes or modifications not expressly approved by the party responsible for compliance could void the user's authority to operate the equipment. The term "IC:" before the radio certification number only signifies that Industry Canada technical specifications were met.

TRA  
REGISTERED No:  
ER98640/21  
  
DEALER No:  
DA37380/15

FCC ID: L2C0066T  
FCC ID: L2C0084T  
FCC ID: L2C0074TR  
FCC ID: L2C0084TR  
IC ID: 3432A-0074TR



## Customer Information

This device complies with Part 15 of the FCC Rules and with Innovation, Science and Economic Development Canada's licence-exempt RSS(s). Operation is subject to the following two conditions:

1. This device may not cause harmful interference, and
2. This device must accept any interference received, including interference that may cause undesired operation.

### Vietnam



### Zambia



### PERCHLORATE

Certain components in your vehicle such as airbag modules, seatbelt pretensioners and remote control batteries may contain perchlorate material. Special handling may apply for service or vehicle end of life disposal.

For more information visit:  
[www.dtsc.ca.gov/hazardouswaste/perchlorate](http://www.dtsc.ca.gov/hazardouswaste/perchlorate).

### REPLACEMENT PARTS RECOMMENDATION

We have built your vehicle to the highest standards using quality parts. We recommend that you demand the use of genuine Ford and Motorcraft parts whenever your vehicle requires scheduled maintenance or repair. You can clearly identify genuine Ford and Motorcraft parts by looking for the Ford, FoMoCo or Motorcraft branding on the parts or their packaging.

### Scheduled Maintenance and Mechanical Repairs

One of the best ways for you to make sure that your vehicle provides years of service is to have it maintained in line with our recommendations using parts that conform to the specifications detailed in this Owner's Manual.

# Customer Information

---

Genuine Ford and Motorcraft parts meet or exceed these specifications.

## Collision Repairs

We hope that you never experience a collision, but accidents happen sometimes.

Genuine Ford replacement collision parts meet our stringent requirements for fit, finish, structural integrity, corrosion protection and dent resistance. During vehicle development we validate that these parts deliver the intended level of protection as a whole system. A great way to know for sure you are getting this level of protection is to use genuine Ford replacement collision parts.

## Warranty on Replacement Parts

Genuine Ford and Motorcraft replacement parts are the only replacement parts that benefit from a Ford Warranty.

The Ford Warranty may not cover damage caused to your vehicle as a result of failed non-Ford parts.

For additional information, refer to the terms and conditions of the Ford Warranty.

## MOBILE COMMUNICATIONS EQUIPMENT



**WARNING:** Driving while distracted can result in loss of vehicle control, crash and injury. We strongly recommend that you use extreme caution when using any device that may take your focus off the road. Your primary responsibility is the safe operation of your vehicle. We recommend against the use of any

hand-held device while driving and encourage the use of voice-operated systems when possible. Make sure you are aware of all applicable local laws that may affect the use of electronic devices while driving.

Using mobile communications equipment is becoming increasingly important in the conduct of business and personal affairs. However, you must not compromise your own or others' safety when using such equipment. Mobile communications can enhance personal safety and security when appropriately used, particularly in emergency situations. Safety must be paramount when using mobile communications equipment to avoid negating these benefits. Mobile communication equipment includes, but is not limited to, cellular phones, pagers, portable email devices, text messaging devices and portable two-way radios.

# Customer Information

## END USER LICENSE AGREEMENT

### VEHICLE SOFTWARE END USER LICENSE AGREEMENT (EULA)

- You ("You" or "Your" as applicable) have acquired a vehicle having several devices, including SYNC ® and various control modules, ("DEVICES") that include software licensed or owned by Ford Motor Company and its affiliates ("FORD MOTOR COMPANY"). Those software products of FORD MOTOR COMPANY origin, as well as associated media, printed materials, and "online" or electronic documentation ("SOFTWARE") are protected by international intellectual property laws and treaties. The SOFTWARE is licensed, not sold. All rights reserved.
- The SOFTWARE may interface with and/or communicate with, or may be later upgraded to interface with and/or communicate with additional software and/or systems provided by FORD MOTOR COMPANY.

**IF YOU DO NOT AGREE TO THIS END USER LICENSE AGREEMENT ("EULA") DO NOT USE THE DEVICES OR COPY THE SOFTWARE. ANY USE OF THE SOFTWARE, INCLUDING BUT NOT LIMITED TO USE ON THE DEVICES, WILL CONSTITUTE YOUR AGREEMENT TO THIS EULA (OR RATIFICATION OF ANY PREVIOUS CONSENT).**

**GRANT OF SOFTWARE LICENSE:** This EULA grants you the following license:

- You may use the SOFTWARE as installed on the DEVICES and as otherwise interfacing with systems and/or services provide by or through FORD MOTOR COMPANY or its third party software and service providers.

## Description of Other Rights and Limitations.

- **Speech Recognition:** If the SOFTWARE includes speech recognition component(s), you should understand that speech recognition is an inherently statistical process and that recognition errors are inherent in the process. Neither FORD MOTOR COMPANY nor its suppliers shall be liable for any damages arising out of errors in the speech recognition process. It is your responsibility to monitor any speech recognition functions included in the system.
- **Limitations on Reverse Engineering, Decompilation and Disassembly:** You may not reverse engineer, decompile, translate, disassemble or attempt to discover any source code or underlying ideas or algorithms of the SOFTWARE nor permit others to reverse engineer, decompile or disassemble the SOFTWARE, except and only to the extent that such activity is expressly permitted by applicable law notwithstanding this limitation or to the extent as may be permitted by the licensing terms governing use of any open source components included with the SOFTWARE.
- **Limitations on Distributing, Copying, Modifying and Creating Derivative Works:** You may not distribute, copy, make modifications to or create derivative works based on the SOFTWARE, except and only to the extent that such activity is expressly permitted by applicable law notwithstanding this limitation or to the extent as may be permitted by the licensing terms governing use of any open source components included with the SOFTWARE.

# Customer Information

---

- **Single EULA:** The end user documentation for the DEVICES and related systems and services may contain multiple EULAs, such as multiple translations and/or multiple media versions (e.g., in the user documentation and in the software). Even if you receive multiple EULAs, you are licensed to use only one (1) copy of the SOFTWARE.
- **SOFTWARE Transfer:** You may permanently transfer your rights under this EULA only as part of a sale or transfer of the DEVICES, provided you retain no copies, you transfer all of the SOFTWARE (including all component parts, the media and printed materials, any upgrades, and, if applicable, the Certificate(s) of Authenticity), and the recipient agrees to the terms of this EULA. If the SOFTWARE is an upgrade, any transfer must include all prior versions of the SOFTWARE.
- **Termination:** Without prejudice to any other rights, FORD MOTOR COMPANY may terminate this EULA if you fail to comply with the terms and conditions of this EULA.
- **Internet-Based Services Components:** The SOFTWARE may contain components that enable and facilitate the use of certain Internet-based services. You acknowledge and agree that FORD MOTOR COMPANY, third party software and service suppliers, its affiliates and/or its designated agent may automatically check the version of the SOFTWARE and/or its components that you are utilizing and may provide upgrades or supplements to the SOFTWARE that may be automatically downloaded to your DEVICES.
- **Additional Software/Services:** The SOFTWARE may permit FORD MOTOR COMPANY, third party software and service suppliers, its affiliates and/or its designated agent to provide or make available to you SOFTWARE updates, supplements, add-on components, or Internet-based services components of the SOFTWARE after the date you obtain your initial copy of the SOFTWARE ("Supplemental Components".) SOFTWARE updates may cause you to incur additional charges from your wireless service provider. If FORD MOTOR COMPANY or third party software and services suppliers provide or make available to you Supplemental Components and no other EULA terms are provided along with the Supplemental Components, then the terms of this EULA shall apply. FORD MOTOR COMPANY, its affiliates and/or its designated agent reserve the right to discontinue without liability any Internet-based services provided to you or made available to you through the use of the SOFTWARE.

# Customer Information

---

- **Links to Third Party Sites:** The SOFTWARE may provide you with the ability to link to third party sites. The third party sites are not under the control of FORD MOTOR COMPANY, its affiliates and/or its designated agent. Neither FORD MOTOR COMPANY nor its affiliates nor its designated agent are responsible for (i) the contents of any third party sites, any links contained in third party sites, or any changes or updates to third party sites, or (ii) webcasting or any other form of transmission received from any third party sites. If the SOFTWARE provides links to third party sites, those links are provided to you only as a convenience, and the inclusion of any link does not imply an endorsement of the third party site by FORD MOTOR COMPANY, its affiliates and/or its designated agent.
- **Obligation to Drive Responsibly:** You recognize your obligation to drive responsibly and keep attention on the road. You will read and abide with the DEVICES operating instructions particularly as they pertain to safety and you agree to assume any risk associated with the use of the DEVICES.

## **UPGRADES AND RECOVERY MEDIA:**

If the SOFTWARE is provided by FORD MOTOR COMPANY separate from the DEVICES on media such as a ROM chip, CD ROM disk(s) or via web download or other means, and is labeled "For Upgrade Purposes Only" or "For Recovery Purposes Only" you may install one (1) copy of such SOFTWARE onto the DEVICES as a replacement copy for the existing SOFTWARE, and use it in accordance with this EULA, including any additional EULA terms accompanying the upgrade SOFTWARE.

## **INTELLECTUAL PROPERTY RIGHTS:**

All title and intellectual property rights in and to the SOFTWARE (including but not limited to any images, photographs, animations, video, audio, music, text and "applets" incorporated into the SOFTWARE), the accompanying printed materials, and any copies of the SOFTWARE, are owned by FORD MOTOR COMPANY, or its affiliates or suppliers. The SOFTWARE is licensed, not sold. You may not copy the printed materials accompanying the SOFTWARE. All title and intellectual property rights in and to the content which may be accessed through use of the SOFTWARE is the property of the respective content owner and may be protected by applicable copyright or other intellectual property laws and treaties. This EULA grants you no rights to use such content outside its intended use. All rights not specifically granted under this EULA are reserved by FORD MOTOR COMPANY, its affiliates, and third party software and service providers and suppliers. Use of any on-line services which may be accessed through the SOFTWARE may be governed by the respective terms of use relating to such services. If this SOFTWARE contains documentation that is provided only in electronic form, you may print one copy of such electronic documentation.

**EXPORT RESTRICTIONS:** You acknowledge that the SOFTWARE is subject to U.S. and European Union export jurisdiction. You agree to comply with all applicable international and national laws that apply to the SOFTWARE, including the U.S. Export Administration Regulations, as well as end-user, end-use and destination restrictions issued by U.S. and other governments.

# Customer Information

---

**TRADEMARKS:** This EULA does not grant you any rights in connection with any trademarks or service marks of FORD MOTOR COMPANY, its affiliates, and third party software and service providers.

**PRODUCT SUPPORT:** Please refer to FORD MOTOR COMPANY instructions provided in the documentation for the DEVICES product support, such as the vehicle owner guide.

Should you have any questions concerning this EULA, or if you desire to contact FORD MOTOR COMPANY for any other reason, please refer to the address provided in the documentation for the DEVICES.

**No Liability for Certain Damages:** EXCEPT AS PROHIBITED BY LAW, FORD MOTOR COMPANY, ANY THIRD PARTY SOFTWARE OR SERVICES SUPPLIERS, AND THEIR AFFILIATES SHALL HAVE NO LIABILITY FOR ANY INDIRECT, SPECIAL, CONSEQUENTIAL OR INCIDENTAL DAMAGES ARISING FROM OR IN CONNECTION WITH THE USE OR PERFORMANCE OF THE SOFTWARE. THIS LIMITATION SHALL APPLY EVEN IF ANY REMEDY FAILS OF ITS ESSENTIAL PURPOSE. THERE ARE NO WARRANTIES OTHER THAN THOSE THAT MAY BE EXPRESSLY PROVIDED FOR YOUR NEW VEHICLE.

## **SYNC® Automotive Important Safety Information Read and follow instructions:**

- Before using your SYNC® system, read and follow all instructions and safety information provided in this end user manual ("Owner Guide".) Not following precautions found in the Owner Guide can lead to an accident or other serious injuries.

## General Operation

- **Voice Command Control:** Certain functions within the SYNC® system may be accomplished using voice commands. Using voice commands while driving helps you to operate the system without removing your hands from the wheel or eyes from the road.
- **Prolonged Views of Screen:** Do not access any function requiring a prolonged view of the screen while you are driving. Pull over in a safe and legal manner before attempting to access a function of the system requiring prolonged attention.
- **Volume Setting:** Do not raise the volume excessively. Keep the volume at a level where you can still hear outside traffic and emergency signals while driving. Driving while unable to hear these sounds could cause an accident.
- **Navigation Features:** Any navigation features included in the system are intended to provide turn by turn instructions to get you to a desired destination. Please make certain all persons using this system carefully read and follow instructions and safety information fully.
- **Distraction Hazard:** Any navigation features may require manual (non-verbal) setup. Attempting to perform such set-up or insert data while driving can distract your attention and could cause an accident or other serious injury. Stop the vehicle in a safe and legal manner before attempting these operations.
- **Let Your Judgment Prevail:** Any navigation features are provided only as an aid. Make your driving decisions based on your observations of local conditions and existing traffic regulations. Any such feature is not a

# Customer Information

---

substitute for your personal judgment. Any route suggestions made by this system should never replace any local traffic regulations or your personal judgment or knowledge of safe driving practices.

- **Route Safety:** Do not follow the route suggestions if doing so would result in an unsafe or illegal maneuver, if you would be placed in an unsafe situation, or if you would be directed into an area that you consider unsafe. The driver is ultimately responsible for the safe operation of the vehicle and therefore, must evaluate whether it is safe to follow the suggested directions.
- **Potential Map Inaccuracy:** Maps used by this system may be inaccurate because of changes in roads, traffic controls or driving conditions. Always use good judgment and common sense when following the suggested routes.
- **Emergency Services:** Do not rely on any navigation features included in the system to route you to emergency services. Ask local authorities or an emergency services operator for these locations. Not all emergency services such as police, fire stations, hospitals and clinics are likely to be contained in the map database for such navigation features.

Your Responsibilities and Assumptions of Risk

- You agree to each of the following:(a) Any use of the SOFTWARE while driving an automobile or other vehicle in violation of applicable law or otherwise driving in an unsafe manner presents a significant risk of distracted driving and should not be attempted under any circumstances;(b) Use of the SOFTWARE at excessive volume poses a significant risk of hearing damage and should not be attempted under any circumstances;(c) The SOFTWARE may not be compatible with new or different versions of an operating system, third party software, or third party services, and the SOFTWARE may potentially cause a critical failure of an operating system, third party software, or third party service.(d) Any third party service accessed by or third party software used with the SOFTWARE (i) may charge an additional fee for access, (ii) may not work correctly, on an uninterrupted basis, or error free, (iii) may change streaming formats or discontinue operation, (iv) may contain adult, profane or offensive content; and (v) may contain inaccurate, false or misleading traffic, weather, financial or safety information or other content; and (e) Use of the SOFTWARE may cause you to incur additional charges from your wireless service provider (WSP) and any data or minute calculators that may be included in the software program are for reference only, are not warranted in any way and should not be relied upon in anyway.
- When using the SOFTWARE, you agree to be responsible for and assume the entire risk to the items set forth in Section (a) – (e) above.

# Customer Information

---

## Disclaimer of Warranty

YOU EXPRESSLY ACKNOWLEDGE AND AGREE THAT USE OF THE DEVICES AND SOFTWARE IS AT YOUR SOLE RISK AND THAT THE ENTIRE RISK AS TO SATISFACTORY QUALITY, PERFORMANCE, COMPATIBILITY, ACCURACY AND EFFORT IS WITH YOU. TO THE MAXIMUM EXTENT PERMITTED BY APPLICABLE LAW, THE SOFTWARE AND ANY THIRD PARTY SOFTWARE OR THIRD-PARTY SERVICES ARE PROVIDED "AS IS" AND "AS AVAILABLE", WITH ALL FAULTS AND WITHOUT WARRANTY OF ANY KIND, AND FORD MOTOR COMPANY HEREBY DISCLAIMS ALL WARRANTIES AND CONDITIONS WITH RESPECT TO THE SOFTWARE, THIRD PARTY SOFTWARE, AND THIRD-PARTY SERVICES, EITHER EXPRESS, IMPLIED OR STATUTORY, INCLUDING, BUT NOT LIMITED TO, THE IMPLIED WARRANTIES AND/OR CONDITIONS OF MERCHANTABILITY, OF SATISFACTORY QUALITY, OF FITNESS FOR AN PARTICULAR PURPOSE, OF ACCURACY, OF QUIET ENJOYMENT, AND NON-INFRINGEMENT OF THIRD-PARTY RIGHTS. FORD MOTOR COMPANY DOES NOT WARRANT (a) AGAINST INTERFERENCE WITH YOUR ENJOYMENT OF THE SOFTWARE, THIRD PARTY SOFTWARE, OR THIRD-PARTY SERVICES, (b) THAT THE SOFTWARE, THIRD PARTY SOFTWARE, OR THIRD-PARTY SERVICES WILL MEET YOUR REQUIREMENTS, (c) THAT THE OPERATION OF THE SOFTWARE, THIRD PARTY SOFTWARE, OR THIRD-PARTY SERVICES WILL BE UNINTERRUPTED OR ERROR-FREE, (d) OR THAT DEFECTS IN THE SOFTWARE, THIRD PARTY SOFTWARE, OR THIRD-PARTY SERVICES WILL BE CORRECTED. NO ORAL OR WRITTEN INFORMATION OR ADVICE GIVEN BY FORD MOTOR COMPANY OR ITS AUTHORIZED REPRESENTATIVE SHALL

CREATE A WARRANTY. SHOULD THE SOFTWARE, THIRD PARTY SOFTWARE, OR THIRD-PARTY SERVICES PROVE DEFECTIVE, YOU ASSUME THE ENTIRE COST OF ALL NECESSARY SERVICING, REPAIR OR CORRECTION. SOME JURISDICTIONS DO NOT ALLOW THE DISCLAIMER OF IMPLIED WARRANTIES OR LIMITATIONS ON APPLICABLE STATUTORY RIGHTS OF A CONSUMER, SO THE ABOVE DISCLAIMER MAY NOT FULLY APPLY TO YOU. THE SOLE WARRANTY PROVIDED BY FORD MOTOR COMPANY SHALL BE FOUND IN THE WARRANTY INFORMATION INCLUDING WITH YOUR OWNER GUIDE. TO THE EXTENT THAT THERE IS ANY CONFLICT BETWEEN THE TERMS OF THIS SECTION AND THE WARRANTY BOOKLET, THE WARRANTY BOOKLET SHALL CONTROL.

## Applicable Law, Venue, Jurisdiction

- The laws of the State of Michigan govern this EULA and Your use of the SOFTWARE. Your use of the SOFTWARE may also be subject to other local, state, national, or international laws. Any litigation arising out of or related to this EULA shall be brought and maintained exclusively in a court of the State of Michigan located in Wayne County or in the United States District Court for the Eastern District of Michigan. You hereby consent to submit to the personal jurisdiction of a court in the State of Michigan located in Wayne County and the United States District Court for the Eastern District of Michigan for any dispute arising out of or relating to this EULA.



## Customer Information

---

### **Binding Arbitration and Class Action Waiver**

**(a) Application.** This Section applies to any dispute EXCEPT IT DOES NOT INCLUDE A DISPUTE RELATING TO COPYRIGHT INFRINGEMENT, OR TO THE ENFORCEMENT OR VALIDITY OF YOUR, FORD MOTOR COMPANY, OR ANY OF FORD MOTOR COMPANY'S LICENSORS' INTELLECTUAL PROPERTY RIGHTS.

Dispute means any dispute, action, or other controversy between You and FORD MOTOR COMPANY, other than the exceptions listed above, concerning the SOFTWARE (including its price) or this EULA, whether in contract, warranty, tort, statute, regulation, ordinance, or any other legal or equitable basis.

**(b) Notice of Dispute.** In the event of a Dispute, You or FORD MOTOR COMPANY must give the other a "Notice of Dispute", which is a written statement of the name, address, and contact information of the party giving it, the facts giving rise to the dispute, and the relief requested. You and FORD MOTOR COMPANY will attempt to resolve any dispute through informal negotiation within 60 days from the date the Notice of Dispute is sent. After 60 days, You or FORD MOTOR COMPANY may commence arbitration.

**(c) Small claims court.** You may also litigate any dispute in small claims court in your county of residence or FORD MOTOR COMPANY'S principal place of business, if the dispute meets all requirements to be heard in the small claims court. You may litigate in small claims court whether or not You negotiated informally first.

**(d) Binding arbitration.** If You and FORD MOTOR COMPANY, do not resolve any dispute by informal negotiation or in small claims court, any other effort to resolve the dispute will be conducted exclusively by binding arbitration. You are giving up

the right to litigate (or participate in as a party or class member) all disputes in court before a judge or jury. Instead, all disputes will be resolved before a neutral arbitrator, whose decision will be final except for a limited right of appeal under the Federal Arbitration Act. Any court with jurisdiction over the parties may enforce the arbitrator's award.

**(e) Class action waiver.** Any proceedings to resolve or litigate any dispute in any forum will be conducted solely on an individual basis. Neither you nor FORD MOTOR COMPANY, will seek to have any dispute heard as a class action, as a private attorney general action, or in any other proceeding in which any party acts or proposes to act in a representative capacity. No arbitration or proceeding will be combined with another without the prior written consent of all parties to all affected arbitrations or proceedings.

**(f) Arbitration procedure.** Any arbitration will be conducted by the American Arbitration Association (the "AAA"), under its Commercial Arbitration Rules. If You are an individual and use the SOFTWARE for personal or vehicle use, or if the value of the dispute is \$75,000 or less whether or not You are an individual or how You use the SOFTWARE, the AAA Supplementary Procedures for Consumer-Related Disputes will also apply. To commence arbitration, submit a Commercial Arbitration Rules Demand for Arbitration form to the AAA. You may request a telephonic or in-person hearing by following the AAA rules. In a dispute involving \$10,000 or less, any hearing will be telephonic unless the arbitrator finds good cause to hold an in-person hearing instead. For more information, see [adr.org](http://adr.org) or call 1-800-778-7879. You agree to commence arbitration only in your county of residence or FORD MOTOR COMPANY'S principal place of business. The arbitrator

## Customer Information

---

may award the same damages to you individually as a court could. The arbitrator may award declaratory or injunctive relief only to you individually, and only to the extent required to satisfy your individual claim.

### **(g) Arbitration fees and incentives.**

- i. Disputes involving \$75,000 or less. FORD MOTOR COMPANY will promptly reimburse your filing fees and pay the AAA's and arbitrator's fees and expenses. If you reject FORD MOTOR COMPANY'S last written settlement offer made before the arbitrator was appointed ("last written offer"), your dispute goes all the way to an arbitrator's decision (called an "award"), and the arbitrator awards you more than the last written offer, FORD MOTOR COMPANY will give you three incentives: (1) pay the greater of the award or \$1,000; (2) pay twice your reasonable attorney's fees, if any; and (3) reimburse any expenses (including expert witness fees and costs) that your attorney reasonably accrues for investigating, preparing, and pursuing your claim in arbitration. The arbitrator will determine the amounts.
- ii. Disputes involving more than \$75,000. The AAA rules will govern payment of filing fees and the AAA's and arbitrator's fees and expenses.
- iii. Disputes involving any amount. In any arbitration you commence, FORD MOTOR COMPANY will seek its AAA or arbitrator's fees and expenses, or Your filing fees it reimbursed, only if the arbitrator finds the arbitration frivolous or brought for an improper purpose. In any arbitration FORD MOTOR COMPANY commences, it will pay all

filing, AAA, and arbitrator's fees and expenses. It will not seek its attorney's fees or expenses from you in any arbitration. Fees and expenses are not counted in determining how much a dispute involves.

**(h) Claims or disputes must be filed within one year.** To the extent permitted by law, any claim or dispute under this EULA to which this Section applies must be filed within one year in small claims court (Section c) or in arbitration (Section d). The one-year period begins when the claim or dispute first could be filed. If such a claim or dispute is not filed within one year, it is permanently barred.

**(i) Severability.** If the class action waiver (Section e) is found to be illegal or unenforceable as to all or some parts of a dispute, then that portion of Section e will not apply to those parts. Instead, those parts will be severed and proceed in a court of law, with the remaining parts proceeding in arbitration. If any other provision of that portion Section e is found to be illegal or unenforceable, that provision will be severed with the remainder of Section e remaining in full force and effect.

### **Telenav Software End User License Agreement**

Please read these terms and conditions carefully before you use the TeleNav Software. Your use of the TeleNav Software indicates that you accept these terms and conditions. If you do not accept these terms and conditions, do not break the seal of the package, launch, or otherwise use the TeleNav Software. TeleNav may revise this Agreement and the privacy policy at any time, with or without notice to you. You agree to visit <http://www.telenav.com> from time to time to review the then current version of this Agreement and of the privacy policy.

# Customer Information

---

## 1. Safe and Lawful Use

You acknowledge that devoting attention to the TeleNav Software may pose a risk of injury or death to you and others in situations that otherwise require your undivided attention, and you therefore agree to comply with the following when using the TeleNav Software:

- (a) observe all traffic laws and otherwise drive safely;
- (b) use your own personal judgment while driving. If you feel that a route suggested by the TeleNav Software instructs you to perform an unsafe or illegal maneuver, places you in an unsafe situation, or directs you into an area that you consider to be unsafe, do not follow such instructions;
- (c) do not input destinations, or otherwise manipulate the TeleNav Software, unless your vehicle is stationary and parked;
- (d) do not use the TeleNav Software for any illegal, unauthorized, unintended, unsafe, hazardous, or unlawful purposes, or in any manner inconsistent with this Agreement;
- (e) arrange all GPS and wireless devices and cables necessary for use of the TeleNav Software in a secure manner in your vehicle so that they will not interfere with your driving and will not prevent the operation of any safety device (such as an airbag).

You agree to indemnify and hold TeleNav harmless against all claims resulting from any dangerous or otherwise inappropriate use of the TeleNav Software in any moving vehicle, including as a result of your failure to comply with the directions above.

## 2. Account Information

You agree: (a) when registering the TeleNav Software, to provide TeleNav with true, accurate, current, and complete information about yourself, and (b) to inform TeleNav promptly of any changes to such information, and to keep it true, accurate, current and complete.

## 3. Software License

- Subject to your compliance with the terms of this Agreement, TeleNav hereby grants to you a personal, non-exclusive, non-transferable license (except as expressly permitted below in connection with your permanent transfer of the TeleNav Software license), without the right to sublicense, to use the TeleNav Software (in object code form only) in order to access and use the TeleNav Software. This license shall terminate upon any termination or expiration of this Agreement. You agree that you will use the TeleNav Software only for your personal business or leisure purposes, and not to provide commercial navigation services to other parties.

### 3.1 License Limitations

- **(a)** reverse engineer, decompile, disassemble, translate, modify, alter or otherwise change the TeleNav Software or any part thereof; **(b)** attempt to derive the source code, audio library or structure of the TeleNav Software without the prior express written consent of TeleNav; **(c)** remove from the TeleNav Software, or alter, any of TeleNav's or its suppliers' trademarks, trade names, logos, patent or copyright notices, or other notices or markings; **(d)**

# Customer Information

---

distribute, sublicense or otherwise transfer the TeleNav Software to others, except as part of your permanent transfer of the TeleNav Software; or **(e)** use the TeleNav Software in any manner that

- i. infringes the intellectual property or proprietary rights, rights of publicity or privacy or other rights of any party,
- ii. violates any law, statute, ordinance or regulation, including but not limited to laws and regulations related to spamming, privacy, consumer and child protection, obscenity or defamation, or
- iii. is harmful, threatening, abusive, harassing, tortuous, defamatory, vulgar, obscene, libelous, or otherwise objectionable; and (f) lease, rent out, or otherwise permit unauthorized access by third parties to the TeleNav Software without advanced written permission of TeleNav.

## 4. Disclaimers

- To the fullest extent permissible pursuant to applicable law, in no event will TeleNav, its licensors and suppliers, or agents or employees of any of the foregoing, be liable for any decision made or action taken by you or anyone else in reliance on the information provided by the TeleNav Software. TeleNav also does not warrant the accuracy of the map or other data used for the TeleNav Software. Such data may not always reflect reality due to, among other things, road closures, construction, weather, new roads and other changing conditions. You are responsible for the entire risk arising out of your use of the TeleNav Software. For example but without limitation, you agree not to rely on the TeleNav Software for critical navigation in areas where the well-being or survival of you or others

is dependent on the accuracy of navigation, as the maps or functionality of the TeleNav Software are not intended to support such high risk applications, especially in more remote geographical areas.

- TELENAV EXPRESSLY DISCLAIMS AND EXCLUDES ALL WARRANTIES IN CONNECTION WITH THE TELENAV SOFTWARE, WHETHER STATUTORY, EXPRESS OR IMPLIED, INCLUDING ALL WARRANTIES WHICH MAY ARISE FROM COURSE OF DEALING, CUSTOM OR TRADE AND INCLUDING, BUT NOT LIMITED TO, THE IMPLIED WARRANTIES OF MERCHANTABILITY, FITNESS FOR A PARTICULAR PURPOSE AND NON-INFRINGEMENT OF THIRD PARTY RIGHTS WITH RESPECT TO THE TELENAV SOFTWARE.
- Certain jurisdictions do not permit the disclaimer of certain warranties, so this limitation may not apply to you.

## 5. Limitation of Liability

- TO THE EXTENT PERMITTED UNDER APPLICABLE LAW, UNDER NO CIRCUMSTANCES SHALL TELENAV OR ITS LICENSORS AND SUPPLIERS BE LIABLE TO YOU OR TO ANY THIRD PARTY FOR ANY INDIRECT, INCIDENTAL, CONSEQUENTIAL, SPECIAL OR EXEMPLARY DAMAGES (INCLUDING IN EACH CASE, BUT NOT LIMITED TO, DAMAGES FOR THE INABILITY TO USE THE EQUIPMENT OR ACCESS DATA, LOSS OF DATA, LOSS OF BUSINESS, LOSS OF PROFITS, BUSINESS INTERRUPTION OR THE LIKE) ARISING OUT OF THE USE OF OR INABILITY TO USE THE TELENAV SOFTWARE, EVEN IF TELENAV HAS BEEN ADVISED OF THE POSSIBILITY OF SUCH DAMAGES. NOTWITHSTANDING ANY DAMAGES THAT YOU MIGHT INCUR FOR ANY

# Customer Information

---

REASON WHATSOEVER (INCLUDING, WITHOUT LIMITATION, ALL DAMAGES REFERENCED HEREIN AND ALL DIRECT OR GENERAL DAMAGES IN CONTRACT, TORT (INCLUDING NEGLIGENCE) OR OTHERWISE), THE ENTIRE LIABILITY OF TELENAV AND OF ALL OF TELENAV'S SUPPLIERS SHALL BE LIMITED TO THE AMOUNT ACTUALLY PAID BY YOU FOR THE TELENAV SOFTWARE. SOME STATES AND/OR JURISDICTIONS DO NOT ALLOW THE EXCLUSION OR LIMITATION OF INCIDENTAL OR CONSEQUENTIAL DAMAGES, SO THE ABOVE LIMITATIONS OR EXCLUSIONS MAY NOT APPLY TO YOU.

## **6. Arbitration and Governing Law**

- You agree that any dispute, claim or controversy arising out of or relating to this Agreement or the TeleNav Software shall be settled by independent arbitration involving a neutral arbitrator and administered by the American Arbitration Association in the County of Santa Clara, California. The arbitrator shall apply the Commercial Arbitration Rules of the American Arbitration Association, and the judgment upon the award rendered by the arbitrator may be entered by any court having jurisdiction. Note that there is no judge or jury in an arbitration proceeding and the decision of the arbitrator shall be binding upon both parties. You expressly agree to waive your right to a jury trial. This Agreement and performance hereunder will be governed by and construed in accordance with the laws of the State of California, without giving effect to its conflict of law provisions. To the extent judicial action is necessary in connection with the binding arbitration, both TeleNav and you agree to submit

to the exclusive jurisdiction of the courts of the County of Santa Clara, California. The United Nations Convention on Contracts for the International Sale of Goods shall not apply.

## **7. Assignment**

- You may not resell, assign, or transfer this Agreement or any of your rights or obligations, except in totality, in connection with your permanent transfer of the TeleNav Software, and expressly conditioned upon the new user of the TeleNav Software agreeing to be bound by the terms and conditions of this Agreement. Any such sale, assignment or transfer that is not expressly permitted under this paragraph will result in immediate termination of this Agreement, without liability to TeleNav, in which case you and all other parties shall immediately cease all use of the TeleNav Software. Notwithstanding the foregoing, TeleNav may assign this Agreement to any other party at any time without notice, provided the assignee remains bound by this Agreement.

## **8. Miscellaneous**

### **8.1**

This Agreement constitutes the entire agreement between TeleNav and you with respect to the subject matter hereof.

### **8.2**

Except for the limited licenses expressly granted in this Agreement, TeleNav retains all right, title and interest in and to the TeleNav Software, including without limitation all related intellectual property rights. No licenses or other rights which are not expressly granted in this Agreement are intended to, or shall be, granted or

# Customer Information

---

conferred by implication, statute, inducement, estoppel or otherwise, and TeleNav and its suppliers and licensors hereby reserve all of their respective rights other than the licenses explicitly granted in this Agreement.

## 8.3

By using the TeleNav Software, you consent to receive from TeleNav all communications, including notices, agreements, legally required disclosures or other information in connection with the TeleNav Software (collectively, "Notices") electronically. TeleNav may provide such Notices by posting them on TeleNav's Website or by downloading such Notices to your wireless device. If you desire to withdraw your consent to receive Notices electronically, you must discontinue your use of the TeleNav Software.

## 8.4

TeleNav's or your failure to require performance of any provision shall not affect that party's right to require performance at any time thereafter, nor shall a waiver of any breach or default of this Agreement constitute a waiver of any subsequent breach or default or a waiver of the provision itself.

## 8.5

If any provision herein is held unenforceable, then such provision will be modified to reflect the intention of the parties, and the remaining provisions of this Agreement will remain in full force and effect.

## 8.6

The headings in this Agreement are for convenience of reference only, will not be deemed to be a part of this Agreement, and will not be referred to in connection with the construction or interpretation of this Agreement. As used in this Agreement, the words "include" and "including" and variations thereof, will not be deemed to be terms of limitation, but rather will be deemed to be followed by the words "without limitation".

## 9. Other Vendors Terms and Conditions

- The Telenav Software utilizes map and other data licensed to Telenav by third party vendors for the benefit of you and other end users. This Agreement includes end-user terms applicable to these companies (included at the end of this Agreement), and thus your use of the Telenav Software is also subject to such terms. You agree to comply with the following additional terms and conditions, which are applicable to Telenav's third party vendor licensors.

## 9.1 End User Terms Required by HERE North America, LLC

The data ("Data") is provided for your personal, internal use only and not for resale. It is protected by copyright, and is subject to the following terms and conditions which are agreed to by you, on the one hand, and Telenav ("Telenav") and its licensors (including their licensors and suppliers) on the other hand.

© 2013 HERE. All rights reserved.

The Data for areas of Canada includes information taken with permission from Canadian authorities, including: © Her Majesty the Queen in Right of Canada, © Queen's Printer for Ontario, © Canada Post Corporation, GeoBase®, © Department of Natural Resources Canada.

# Customer Information

---

HERE holds a non-exclusive license from the United States Postal Service® to publish and sell ZIP+4® information.

©United States Postal Service® 2014. Prices are not established, controlled or approved by the United States Postal Service®. The following trademarks and registrations are owned by the USPS: United States Postal Service, USPS, and ZIP+4

The Data for Mexico includes certain data from Instituto Nacional de Estadística y Geografía.

## **9.2 End User Terms Required by NAV2 (Shanghai) Co., Ltd**

The data (“Data”) is provided for your personal, internal use only and not for resale. It is protected by copyright, and is subject to the following terms and conditions which are agreed to by you, on the one hand, and NAV2 (Shanghai) Co., Ltd (“NAV2”) and its licensors (including their licensors and suppliers) on the other hand. 20xx. All rights reserved

### **Terms and Conditions**

**Permitted Use.** You agree to use this Data together with the Telenav Software solely for the internal business and personal purposes for which you were licensed, and not for service bureau, time-sharing or other similar purposes. Accordingly, but subject to the restrictions set forth in the following paragraphs, you agree not to otherwise reproduce, copy, modify, decompile, disassemble, create any derivative works of, or reverse engineer any portion of this Data, and may not transfer or distribute it in any form, for any purpose, except to the extent permitted by mandatory laws.

**Restrictions.** Except where you have been specifically licensed to do so by Telenav, and without limiting the preceding paragraph, you may not use this Data (a) with any products, systems, or applications installed or otherwise connected to or in communication with vehicles, capable of vehicle navigation, positioning, dispatch, real time route guidance, fleet management or similar applications; or (b) with or in communication with any positioning devices or any mobile or wireless-connected electronic or computer devices, including without limitation cellular phones, palmtop and handheld computers, pagers, and personal digital assistants or PDAs.

**Warning.** The Data may contain inaccurate or incomplete information due to the passage of time, changing circumstances, sources used and the nature of collecting comprehensive geographic data, any of which may lead to incorrect results.

**No Warranty.** This Data is provided to you “as is,” and you agree to use it at your own risk. Telenav and its licensors (and their licensors and suppliers) make no guarantees, representations or warranties of any kind, express or implied, arising by law or otherwise, including but not limited to, content, quality, accuracy, completeness, effectiveness, reliability, fitness for a particular purpose, usefulness, use or results to be obtained from this Data, or that the Data or server will be uninterrupted or error-free.

**Disclaimer of Warranty:** TELENAV AND ITS LICENSORS (INCLUDING THEIR LICENSORS AND SUPPLIERS) DISCLAIM ANY WARRANTIES, EXPRESS OR IMPLIED, OF QUALITY, PERFORMANCE, MERCHANTABILITY, FITNESS FOR A

## Customer Information

---

PARTICULAR PURPOSE OR NON-INFRINGEMENT. Some States, Territories and Countries do not allow certain warranty exclusions, so to that extent the above exclusion may not apply to you.

**Disclaimer of Liability:** TELENAV AND ITS LICENSORS (INCLUDING THEIR LICENSORS AND SUPPLIERS) SHALL NOT BE LIABLE TO YOU: IN RESPECT OF ANY CLAIM, DEMAND OR ACTION, IRRESPECTIVE OF THE NATURE OF THE CAUSE OF THE CLAIM, DEMAND OR ACTION ALLEGING ANY LOSS, INJURY OR DAMAGES, DIRECT OR INDIRECT, WHICH MAY RESULT FROM THE USE OR POSSESSION OF THE INFORMATION; OR FOR ANY LOSS OF PROFIT, REVENUE, CONTRACTS OR SAVINGS, OR ANY OTHER DIRECT, INDIRECT, INCIDENTAL, SPECIAL OR CONSEQUENTIAL DAMAGES ARISING OUT OF YOUR USE OF OR INABILITY TO USE THIS INFORMATION, ANY DEFECT IN THE INFORMATION, OR THE BREACH OF THESE TERMS OR CONDITIONS, WHETHER IN AN ACTION IN CONTRACT OR TORT OR BASED ON A WARRANTY, EVEN IF TELENAV OR ITS LICENSORS HAVE BEEN ADVISED OF THE POSSIBILITY OF SUCH DAMAGES. Some States, Territories and Countries do not allow certain liability exclusions or damages limitations, so to that extent the above may not apply to you.

**Export Control.** You shall not export from anywhere any part of the Data or any direct product thereof except in compliance with, and with all licenses and approvals required under, applicable export laws, rules and regulations, including but not limited to the laws, rules and regulations administered by the Office of Foreign Assets Control of the U.S. Department of Commerce and the Bureau of Industry and Security of the U.S. Department of Commerce. To the extent that any such

export laws, rules or regulations prohibit HERE from complying with any of its obligations hereunder to deliver or distribute Data, such failure shall be excused and shall not constitute a breach of this Agreement.

**Entire Agreement.** These terms and conditions constitute the entire agreement between Telenav (and its licensors, including their licensors and suppliers) and you pertaining to the subject matter hereof, and supersedes in their entirety any and all written or oral agreements previously existing between us with respect to such subject matter.

**Governing Law.** The above terms and conditions shall be governed by the laws of the State of Illinois [insert "Netherlands" where European HERE Data is used], without giving effect to (i) its conflict of laws provisions, or (ii) the United Nations Convention for Contracts for the International Sale of Goods, which is explicitly excluded. You agree to submit to the jurisdiction of the State of Illinois [insert "The Netherlands" where European HERE Data is used] for any and all disputes, claims and actions arising from or in connection with the Data provided to you hereunder.

**Government End Users.** If the Data is being acquired by or on behalf of the United States government or any other entity seeking or applying rights similar to those customarily claimed by the United States government, this Data is a "commercial item" as that term is defined at 48 C.F.R. ("FAR") 2.101, is licensed in accordance with these End-User Terms, and each copy of Data delivered or otherwise furnished shall be marked and embedded as appropriate with the following "Notice of Use," and shall be treated in accordance with such Notice:



# Customer Information

## NOTICE OF USE

CONTRACTOR (MANUFACTURER/  
SUPPLIER) NAME: HERE

CONTRACTOR (MANUFACTURER/  
SUPPLIER) ADDRESS: c/o Nokia, 425  
West Randolph Street, Chicago, Illinois  
60606

This Data is a commercial item as  
defined in FAR 2.101 and is subject to  
these End-User Terms under which this  
Data was provided.

© 1987 – 2014 HERE – All rights reserved.

If the Contracting Officer, federal government agency, or any federal official refuses to use the legend provided herein, the Contracting Officer, federal government agency, or any federal official must notify HERE prior to seeking additional or alternative rights in the Data.

### I. US/Canada Territory

A. United States Data. The End-User Terms for any Application containing Data for the United States shall contain the following notices:

“HERE holds a non-exclusive license from the United States Postal Service® to publish and sell ZIP+4® information.”

“©United States Postal Service® 20XX. Prices are not established, controlled or approved by the United States Postal Service®. The following trademarks and registrations are owned by the USPS: United States Postal Service, USPS, and ZIP+4.”

B. Canada Data. The following provisions apply to the Data for Canada, which may include or reflect data from third party licensors (“Third Party Data”), including Her Majesty the Queen in Right of Canada (“Her Majesty”), Canada Post Corporation (“Canada Post”) and the Department of Natural Resources of Canada (“NRCan”):

1. Disclaimer and Limitation: Client agrees that its use of the Third Party Data is subject to the following provisions:

a. Disclaimer: The Third Party Data is licensed on an “as is” basis. The licensors of such data, including Her Majesty, Canada Post and NRCan, make no guarantees, representations or warranties respecting such data, either express or implied, arising by law or otherwise, including but not limited to, effectiveness, completeness, accuracy or fitness for a particular purpose.

b. Limitation on Liability: The Third Party Data licensors, including Her Majesty, Canada Post and NRCan, shall not be liable: (i) in respect of any claim, demand or action, irrespective of the nature of the cause of the claim, demand or action alleging any loss, injury or damages, direct or indirect, which may result from the use or possession of such Data; or (ii) in any way for loss of revenues or contracts, or any other consequential loss of any kind resulting from any defect in the Data.

## Customer Information

---

2. Copyright Notice: In connection with each copy of all or any portion of the Data for the Territory of Canada, Client shall affix in a conspicuous manner the following copyright notice on at least one of: (i) the label for the storage media of the copy; (ii) the packaging for the copy; or (iii) other materials packaged with the copy, such as user manuals or end user license agreements: "This data includes information taken with permission from Canadian authorities, including © Her Majesty the Queen in Right of Canada, © Queen's Printer for Ontario, © Canada Post Corporation, GeoBase®, © The Department of Natural Resources Canada. All rights reserved."

3. End-User Terms: Except as otherwise agreed by the parties, in connection with the provision of any portion of the Data for the Territory of Canada to End-Users as may be authorized under the Agreement, Client shall provide such End-Users, in a reasonably conspicuous manner, with terms (set forth with other end user terms required to be provided under the Agreement, or as otherwise may be provided, by Client) which shall include the following provisions on behalf of the Third Party Data licensors, including Her Majesty, Canada Post and NRCan:

The Data may include or reflect data of licensors, including Her Majesty the Queen in the Right of Canada ("Her Majesty"), Canada Post Corporation ("Canada Post") and the Department of Natural Resources Canada ("NRCan"). Such data is licensed on an "as is" basis. The licensors, including Her Majesty, Canada Post and NRCan, make no guarantees, representations or warranties respecting such data,

either express or implied, arising by law or otherwise, including but not limited to, effectiveness, completeness, accuracy or fitness for a particular purpose. The licensors, including Her Majesty, Canada Post and NRCan, shall not be liable in respect of any claim, demand or action, irrespective of the nature of the cause of the claim, demand or action alleging any loss, injury or damages, direct or indirect, which may result from the use or possession of the data or the Data. The licensors, including Her Majesty, Canada Post and NRCan, shall not be liable in any way for loss of revenues or contracts, or any other consequential loss of any kind resulting from any defect in the data or the Data.

End User shall indemnify and save harmless the licensors, including Her Majesty, Canada Post and NRCan, and their officers, employees and agents from and against any claim, demand or action, irrespective of the nature of the cause of the claim, demand or action, alleging loss, costs, expenses, damages or injuries (including injuries resulting in death) arising out of the use or possession of the data or the Data.

4. Additional Provisions: The terms contained in this Section are in addition to all of the rights and obligations of the parties under the Agreement. To the extent that any of the provisions of this Section are inconsistent with, or conflict with, any other provisions of the Agreement, the provisions of this Section shall prevail.

# Customer Information

II. Mexico. The following provision applies to the Data for Mexico, which includes certain data from the Instituto Nacional de Estadística y Geografía (“INEGI”):

A. Any and all copies of the Data and/or packaging containing Data for Mexico shall contain the following notice: “Fuente: INEGI (Instituto Nacional de Estadística y Geografía)”

## III. Latin America Territory

A. Third Party Notices. Any and all copies of the Data and/or packaging relating thereto shall include the respective Third Party Notices set forth below and used as described below corresponding to the Territory (or portion thereof) included in such copy:

Territory Notice

Argentina	IGN “INSTITUTO GEOGRAFICO NACIONAL ARGENTINO”
Ecuador	“INSTITUTO GEOGRAFICO MILITAR DEL ECUADOR AUTORIZACION N° IGM-2011-01- PCO-01 DEL 25 DE ENERO DE 2011” “source: © IGN 2009 - BD TOPO ®”
Guadeloupe, French Guiana and Martinique Mexico	“Fuente: INEGI (Instituto Nacional de Estadística y Geografía)”

## IV. Middle East Territory

A. Third Party Notices. Any and all copies of the Data and/or packaging relating thereto shall include the respective Third Party Notices set forth below and used as described below corresponding to the Territory (or portion thereof) included in such copy:

Country Notice

Jordan	“© Royal Jordanian Geographic Centre”. The foregoing notice requirement for Jordan Data is a material term of the Agreement. If Client or any of its permitted sublicensees (if any) fail to meet such requirement, HERE shall have the right to terminate Client’s license with respect to the Jordan Data.
--------	--

B. Jordan Data. Client and its permitted sublicensees (if any) are restricted from licensing and/or otherwise distributing HERE’s database for the country of Jordan (“Jordan Data”) for use in Enterprise Applications to (i) non-Jordanian entities for use of the Jordan Data solely in Jordan or (ii) Jordan-based customers. In addition, Client, its permitted sublicensees (if any) and End-Users are restricted from using the Jordan Data in Enterprise Applications if such party is (i) a non-Jordanian entity using the Jordan Data solely in Jordan or (ii) a Jordan-based customer. For purposes of the foregoing, “Enterprise Applications” shall mean Geomarketing applications, GIS applications, mobile business asset management applications, call center applications, telematics applications, public organization Internet applications or for providing geocoding services.

# Customer Information

---

## V. Europe Territory

### A. Use of Certain Traffic Codes in Europe

1. General Restrictions Applicable to Traffic Codes. Client acknowledges and agrees that in certain countries of the Europe Territory, Client will need to obtain rights directly from third party RDS-TMC code providers to receive and use the Traffic Codes in the Data and to deliver to End-Users Transactions in any way derived from or based on such Traffic Codes. For such countries, HERE shall deliver the Data incorporating Traffic Codes to Client only after receiving certification from Client of its having obtained such rights.

2. Display of Third Party Rights Legends for Belgium. Client shall, for each Transaction that uses Traffic Codes for Belgium, provide the following notice to the End-User: "Traffic Codes for Belgium are provided by the Ministerie van de Vlaamse Gemeenschap and the Ministère de l'Équipement et des Transports."

B. Paper Maps. With respect to any license granted to Client relating to making, selling or distributing paper maps (i.e., a map fixed on a paper or paper-like medium): (a) such license with respect to Data for the Territory of Great Britain is conditioned on Client's entering into and complying with a separate written agreement with the Ordnance Survey ("OS") to create and sell paper maps, Client's paying to the OS any and all applicable paper map royalties, and Client's complying with the OS copyright notice requirements; (b) such license for selling or otherwise distributing for charge with respect to Data for the Territory of Czech Republic

is conditioned on Client's obtaining prior written consent from Kartografie a.s.; (c) such license for selling or distributing with respect to Data for the Territory of Switzerland is conditioned on Client's obtaining a permit from Bundesamt für Landestopografie of Switzerland; (d) Client is restricted from using Data for the Territory of France to create paper maps with a scale between 1:5,000 and 1:250,000; and (e) Client is restricted from using any Data to create, sell or distribute paper maps that are the same or substantially similar, in terms of data content and specific use of color, symbols and scale, to paper maps published by the European national mapping agencies, including without limitation, Landvermessungämter of Germany, Topografische Dienst of the Netherlands, Nationaal Geografisch Instituut of Belgium, Bundesamt für Landestopografie of Switzerland, Bundesamt für Eich-und Vermessungswesen of Austria, and the National Land Survey of Sweden.

C. OS Enforcement. Without limiting Section IV(B) above, with respect to Data for the Territory of Great Britain, Client acknowledges and agrees that the Ordnance Survey ("OS") may bring a direct action against Client to enforce compliance with the OS copyright notice (see Section IV(D) below) and paper map requirements (see Section IV(B) above) contained in this Agreement.

D. Third Party Notices. Any and all copies of the Data and/or packaging relating thereto shall include the respective Third Party Notices set forth below and used as described below corresponding to the Territory (or portion thereof) included in such copy:

Country(ies) Notice

## Customer Information

Austria	“© Bundesamt für Eich- und Vermessungswesen”	Spain	“Información geográfica propiedad del CNIG”
Croatia Cyprus, Estonia, Latvia, Lithuania, Moldova, Poland, Slovenia and/or Ukraine	“© EuroGeographics”	Sweden	“Based upon electronic data © National Land Survey Sweden.”
France	“source: © IGN 2009 – BD TOPO ®”	Switzerland	“Topografische Grundlage: © Bundesamt für Landestopographie.
Germany	“Die Grundlagendaten wurden mit Genehmigung der zuständigen Behörden entnommen”	E. Respective Country Distribution. Client acknowledges that HERE has not received approvals to distribute map data for the following countries in such respective countries: Albania, Belarus, Kyrgyzstan, Moldova and Uzbekistan. HERE may update such list from time to time. The license rights granted to Client under this TL with respect to the Data for such countries are contingent upon Client’s compliance with all applicable laws and regulations, including, without limitation, any required licenses or approvals to distribute the Application incorporating such Data in such respective countries.	
Great Britain	“Contains Ordnance Survey data © Crown copyright and database right 2010 Contains Royal Mail data © Royal Mail copyright and database right 2010”	VI. Australia Territory	
Greece	“Copyright Geomatics Ltd.”	A. Third Party Notices. Any and all copies of the Data and/or packaging relating thereto shall include the respective Third Party Notices set forth below and used as described below corresponding to the Territory (or portion thereof) included in such copy:	
Hungary	“Copyright © 2003; Top-Map Ltd.”	Copyright. Based on data provided under license from PSMA Australia Limited (www.pasma.com.au).	
Italy	“La Banca Dati Italiana è stata prodotta usando quale riferimento anche cartografia numerica ed al tratto prodotta e fornita dalla Regione Toscana.”		
Norway	“Copyright © 2000; Norwegian Mapping Authority”		
Portugal	“Source: IgeoE – Portugal”		

# Customer Information

---

Product incorporates data which is © 20XX Telstra Corporation Limited, GM Holden Limited, Intelomatics Australia Pty Ltd and Continental Pty Ltd.

B. Third Party Notices for Australia. In addition to the foregoing, the End-User Terms for any Application containing RDS-TMC Traffic Codes for Australia shall contain the following notice: “Product incorporates traffic location codes which is © 20XX Telstra Corporation Limited and its licensors.”

## **AT&T Vehicle Network Carrier Telematics Disclosure**

END USER FOR PURPOSES OF THIS SECTION MEANS YOU AND YOUR HEIRS, EXECUTORS, LEGAL PERSONAL REPRESENTATIVES AND PERMITTED ASSIGNS. FOR PURPOSES OF THIS SECTION “UNDERLYING WIRELESS SERVICE CARRIER” INCLUDES ITS AFFILIATES AND CONTRACTORS AND THEIR RESPECTIVE OFFICERS, DIRECTORS, EMPLOYEES, SUCCESSORS AND ASSIGNS. END USER HAS NO CONTRACTUAL RELATIONSHIP WITH THE UNDERLYING WIRELESS SERVICE CARRIER AND END USER IS NOT A THIRD PARTY BENEFICIARY OF ANY AGREEMENT BETWEEN FORD AND UNDERLYING CARRIER. END USER UNDERSTANDS AND AGREES THAT THE UNDERLYING CARRIER HAS NO LEGAL, EQUITABLE, OR OTHER LIABILITY OF ANY KIND TO END USER. IN ANY EVENT, REGARDLESS OF THE FORM OF THE ACTION, WHETHER FOR BREACH OF CONTRACT, WARRANTY, NEGLIGENCE, STRICT LIABILITY IN TORT OR OTHERWISE, END USER’S EXCLUSIVE REMEDY FOR CLAIMS ARISING IN ANY WAY IN CONNECTION WITH THIS AGREEMENT, FOR ANY CAUSE WHATSOEVER, INCLUDING BUT NOT LIMITED TO ANY FAILURE OR

DISRUPTION OF SERVICE PROVIDED HEREUNDER, IS LIMITED TO PAYMENT OF DAMAGES IN AN AMOUNT NOT TO EXCEED THE AMOUNT PAID BY END USER FOR THE SERVICES DURING THE TWO-MONTH PERIOD PRECEDING THE DATE THE CLAIM AROSE.

(ii) END USER AGREES TO INDEMNIFY AND HOLD HARMLESS THE UNDERLYING WIRELESS SERVICE CARRIER AND ITS OFFICERS, EMPLOYEES, AND AGENTS AGAINST ANY AND ALL CLAIMS, INCLUDING WITHOUT LIMITATION CLAIMS FOR LIBEL, SLANDER, OR ANY PROPERTY DAMAGE, PERSONAL INJURY OR DEATH, ARISING IN ANY WAY, DIRECTLY OR INDIRECTLY, IN CONNECTION WITH THIS AGREEMENT OR THE USE, FAILURE TO USE, OR INABILITY TO USE THE DEVICE EXCEPT WHERE THE CLAIMS RESULT FROM THE UNDERLYING CARRIER’S GROSS NEGLIGENCE OR WILLFUL MISCONDUCT. THIS INDEMNITY WILL SURVIVE THE TERMINATION OF THE AGREEMENT.

(iii) END USER HAS NO PROPERTY RIGHT IN ANY NUMBER ASSIGNED TO THE DEVICE.

(iv) END USER UNDERSTANDS THAT FORD AND THE UNDERLYING CARRIER CANNOT GUARANTY THE SECURITY OF WIRELESS TRANSMISSIONS, AND WILL NOT BE LIABLE FOR ANY LACK OF SECURITY RELATING TO THE USE OF THE SERVICES

THE SERVICE IS FOR [END USER’S] USE ONLY AND END USER MAY NOT RESELL THE SERVICE TO ANY OTHER PARTY END USER UNDERSTANDS THAT THE UNDERLYING CARRIER DOES NOT GUARANTEE ANY END USER UNINTERRUPTED SERVICE OR COVERAGE. THE UNDERLYING CARRIER DOES NOT WARRANT THAT END USERS CAN OR WILL BE LOCATED USING THE SERVICE. THE UNDERLYING CARRIER

## Customer Information

---

MAKES NO WARRANTY, EXPRESS OR IMPLIED, OF MERCHANTABILITY OR FITNESS FOR A PARTICULAR PURPOSE, SUITABILITY, OR PERFORMANCE REGARDING ANY SERVICES OR GOODS, AND IN NO EVENT SHALL AT&T BE LIABLE, WHETHER OR NOT DUE TO ITS OWN NEGLIGENCE, FOR ANY: (A) ACT OR OMISSION OF A THIRD PARTY; (B) MISTAKES, OMISSIONS, INTERRUPTIONS, ERRORS, FAILURES TO TRANSMIT, DELAYS, OR DEFECTS IN THE SERVICE PROVIDED BY OR THROUGH THE UNDERLYING CARRIER; (C) DAMAGE OR INJURY CAUSED BY SUSPENSION OR TERMINATION BY THE UNDERLYING CARRIER; OR (D) DAMAGE OR INJURY CAUSED BY A FAILURE OR DELAY IN CONNECTING A CALL TO ANY ENTITY, INCLUDING 911 OR ANY OTHER EMERGENCY SERVICE. TO THE FULL EXTENT ALLOWED BY LAW, THE END USER RELEASES, INDEMNIFIES AND HOLDS THE UNDERLYING CARRIER HARMLESS FROM AND AGAINST ANY AND ALL CLAIMS OF ANY PERSON OR ENTITY FOR DAMAGES OF ANY NATURE ARISING IN ANY WAY FROM OR RELATING TO, DIRECTLY OR INDIRECTLY, SERVICES PROVIDED BY THE UNDERLYING CARRIER OR ANY PERSON'S USE THEREOF, INCLUDING CLAIMS ARISING IN WHOLE OR IN PART FROM THE ALLEGED NEGLIGENCE OF THE UNDERLYING CARRIER.

### **VII. China Territory**

#### ***Personal Use Only***

You agree to use this Data together with [insert name of Client Application] for the solely personal, non-commercial purposes for which you were licensed, and not for service bureau, time-sharing or other similar purposes. Accordingly, but subject to the restrictions set forth in the following paragraphs, you may copy this Data only as necessary for your personal use to (i)

view it, and (ii) save it, provided that you do not remove any copyright notices that appear and do not modify the Data in any way. You agree not to otherwise reproduce, copy, modify, decompile, disassemble or reverse engineer any portion of this Data, and may not transfer or distribute it in any form, for any purpose, except to the extent permitted by mandatory laws.

#### ***Restrictions***

Except where you have been specifically licensed to do so by NAV2, and without limiting the preceding paragraph, you may not (a) use this Data with any products, systems, or applications installed or otherwise connected to or in communication with vehicles, capable of vehicle navigation, positioning, dispatch, real time route guidance, fleet management or similar applications; or (b) with or in communication with any positioning devices or any mobile or wireless-connected electronic or computer devices, including without limitation cellular phones, palmtop and handheld computers, pagers, and personal digital assistants or PDAs. You agree to cease using this Data if you fail to comply with these terms and conditions.

#### ***Limited Warranty***

NAV2 warrants that (a) the Data will perform substantially in accordance with the accompanying written materials for a period of ninety (90) days from the date of receipt, and (b) any support services provided by NAV2 shall be substantially as described in applicable written materials provided to you by NAV2, and NAV2's support engineers will make commercially reasonable efforts to solve any problem issues.

# Customer Information

---

## **Customer Remedies**

NAV2 and its suppliers' entire liability and your exclusive remedy shall be, at NAV2's sole discretion, either (a) return of the price paid, if any, or (b) repair or replacement of the Data that do not meet NAV2's Limited Warranty and that are returned to NAV2 with a copy of your receipt. This Limited Warranty is void if failure of the Data has resulted from accident, abuse, or misapplication. Any replacement Data will be warranted for the remainder of the original warranty period or thirty (30) days, whichever is longer. Neither these remedies nor any product support services offered by NAV2 are available without proof of purchase from an authorized international source.

## **No Other Warranty:**

EXCEPT FOR THE LIMITED WARRANTY SET FORTH ABOVE AND TO THE EXTENT PERMITTED BY APPLICABLE LAW, NAV2 AND ITS LICENSORS (INCLUDING THEIR LICENSORS AND SUPPLIERS) DISCLAIM ANY WARRANTIES, EXPRESS OR IMPLIED, OF QUALITY, PERFORMANCE, MERCHANTABILITY, FITNESS FOR A PARTICULAR PURPOSE, OWNERSHIP OR NON-INFRINGEMENT. Certain warranty exclusions may not be permitted under applicable law, so to that extent the above exclusion may not apply to you.

## **Limited Liability:**

TO THE EXTENT PERMITTED BY APPLICABLE LAW, NAV2 AND ITS LICENSORS (INCLUDING THEIR LICENSORS AND SUPPLIERS) SHALL NOT BE LIABLE TO YOU: IN RESPECT OF ANY CLAIM, DEMAND OR ACTION, IRRESPECTIVE OF THE NATURE OF THE CAUSE OF THE CLAIM, DEMAND OR ACTION ALLEGING ANY LOSS, INJURY OR DAMAGES, DIRECT OR INDIRECT, WHICH MAY RESULT FROM THE USE OR POSSESSION OF THE INFORMATION; OR

FOR ANY LOSS OF PROFIT, REVENUE, CONTRACTS OR SAVINGS, OR ANY OTHER DIRECT, INDIRECT, INCIDENTAL, SPECIAL OR CONSEQUENTIAL DAMAGES ARISING OUT OF YOUR USE OF OR INABILITY TO USE THIS INFORMATION, ANY DEFECT IN THE INFORMATION, OR THE BREACH OF THESE TERMS OR CONDITIONS, WHETHER IN AN ACTION IN CONTRACT OR TORT OR BASED ON A WARRANTY, EVEN IF NAV2 OR ITS LICENSORS HAVE BEEN ADVISED OF THE POSSIBILITY OF SUCH DAMAGES. UNDER NO CIRCUMSTANCES SHALL NAV2'S OR ITS SUPPLIERS' LIABILITY HEREUNDER EXCEED THE PRICE PAID. Certain liability exclusions may not be permitted under applicable law, so to that extent the above exclusion may not apply to you.

## **Export Control**

You agree not to export to anywhere any part of the Data provided to you or any direct product thereof except in compliance with, and with all licenses and approvals required under, applicable export laws, rules and regulations.

## **IP Protection**

The Data are owned by NAV2 or its suppliers and are protected by applicable copyright and other intellectual property law and treaties. The Data are provided solely on the basis of a license to use, not sale.

## **Entire Agreement**

These terms and conditions constitute the entire agreement between NAV2 (and its licensors, including their licensors and suppliers) and you pertaining to the subject matter hereof, and supersedes in their entirety any and all written or oral agreements previously existing between us with respect to such subject matter.



# Customer Information

---

## **Governing Law.**

The above terms and conditions shall be governed by the laws of the People's Republic of China, without giving effect to (i) its conflict of laws provisions, or (ii) the United Nations Convention for Contracts for the International Sale of Goods, which is explicitly excluded. Any dispute arising from or in connection with the Data provided to you hereunder shall be submitted to the Shanghai International Economic and Trade Arbitration Commission for arbitration.

## **Gracenote® Copyright**

CD and music-related data from Gracenote, Inc., copyright©

2000-2007 Gracenote. Gracenote Software, copyright © 2000-2007 Gracenote. This product and service may practice one or more of the following U.S. Patents 5,987,525; 6,061,680; 6,154,773; 6,161,132; 6,230,192; 6,230,207; 6,240,459; 6,330,593 and other patents issued or pending. Some services supplied under license from Open Globe, Inc. for U.S. Patent 6,304,523.

Gracenote and CDDB are registered trademarks of Gracenote. The Gracenote logo and logotype, and the "Powered by Gracenote™" logo are trademarks of Gracenote.

## **Gracenote® End User License Agreement (EULA)**

This device contains software from Gracenote, Inc. of 2000 Powell Street Emeryville, California 94608 ("Gracenote").

The software from Gracenote (the "Gracenote Software") enables this device to do disc and music file identification and obtain music-related information, including name, artist, track, and title information ("Gracenote Data") from online servers

("Gracenote Servers"), and to perform other functions. You may use Gracenote Data only by means of the intended End User functions of this device. This device may contain content belonging to Gracenote's providers. If so, all of the restrictions set forth herein with respect to Gracenote Data shall also apply to such content and such content providers shall be entitled to all of the benefits and protections set forth herein that are available to Gracenote. You agree that you will use the content from Gracenote ("Gracenote Content"), Gracenote Data, the Gracenote Software, and Gracenote Servers for your own personal, non-commercial use only. You agree not to assign, copy, transfer or transmit the Gracenote Content, Gracenote Software or any Gracenote Data (except in a Tag associated with a music file) to any third party. YOU AGREE NOT TO USE OR EXPLOIT GRACENOTE CONTENT, GRACENOTE DATA, THE GRACENOTE SOFTWARE, OR GRACENOTE SERVERS, EXCEPT AS EXPRESSLY PERMITTED HEREIN.

You agree that your non-exclusive licenses to use the Gracenote Content, Gracenote Data, the Gracenote Software, and Gracenote Servers will terminate if you violate these restrictions. If your licenses terminate, you agree to cease any and all use of the Gracenote Content, Gracenote Data, the Gracenote Software, and Gracenote Servers.

Gracenote, respectively, reserve all rights in Gracenote Data, the Gracenote Software, and the Gracenote Servers and Gracenote Content, including all ownership rights. Under no circumstances will either Gracenote become liable for any payment to you for any information that you provide,

## Customer Information

---

including any copyrighted material or music file information. You agree that Gracenote may enforce its respective rights, collectively or separately, under this agreement against you, directly in each company's own name.

Gracenote uses a unique identifier to track queries for statistical purposes. The purpose of a randomly assigned numeric identifier is to allow Gracenote to count queries without knowing anything about who you are. For more information, see the web page at [www.gracenote.com](http://www.gracenote.com) for the Gracenote Privacy Policy.

THE GRACENOTE SOFTWARE, EACH ITEM OF GRACENOTE DATA AND THE GRACENOTE CONTENT ARE LICENSED TO YOU "AS IS". NEITHER GRACENOTE MAKES ANY REPRESENTATIONS OR WARRANTIES, EXPRESS OR IMPLIED, REGARDING THE ACCURACY OF ANY GRACENOTE DATA FROM THE GRACENOTE SERVERS OR GRACENOTE CONTENT. GRACENOTE COLLECTIVELY AND SEPARATELY RESERVE THE RIGHT TO DELETE DATA AND/OR CONTENT FROM THE COMPANIES' RESPECTIVE SERVERS OR, IN THE CASE OF GRACENOTE, CHANGE DATA CATEGORIES FOR ANY CAUSE THAT GRACENOTE DEEMS SUFFICIENT. NO WARRANTY IS MADE THAT EITHER GRACENOTE CONTENT OR THE GRACENOTE SOFTWARE OR GRACENOTE SERVERS ARE ERROR-FREE OR THAT THE FUNCTIONING OF THE GRACENOTE SOFTWARE OR GRACENOTE SERVERS WILL BE UNINTERRUPTED. GRACENOTE IS NOT OBLIGATED TO PROVIDE YOU WITH ANY ENHANCED OR ADDITIONAL DATA TYPES THAT GRACENOTE MAY CHOOSE TO PROVIDE IN THE FUTURE AND IS FREE TO DISCONTINUE ITS ONLINE SERVICES AT ANY TIME. GRACENOTE DISCLAIMS ALL WARRANTIES EXPRESS OR IMPLIED, INCLUDING, BUT NOT LIMITED TO,

IMPLIED WARRANTIES OF MERCHANTABILITY, FITNESS FOR A PARTICULAR PURPOSE, TITLE, AND NON-INFRINGEMENT. NEITHER GRACENOTE WARRANTS THE RESULTS THAT WILL BE OBTAINED BY YOUR USE OF THE GRACENOTE SOFTWARE OR ANY GRACENOTE SERVER. IN NO CASE WILL GRACENOTE BE LIABLE FOR ANY CONSEQUENTIAL OR INCIDENTAL DAMAGES OR FOR ANY LOST PROFITS OR LOST REVENUES FOR ANY REASON WHATSOEVER. © Gracenote 2007.

### ***Taiwan Territory***

According to the "Technical Specifications for Low Power Radio Frequency Equipment" formulated by the National Communications and Communication Committee of the Executive Yuan: 3.8.2. For the low-power radio frequency equipment that has obtained the verification certificate, the company, firm or user shall not change the frequency, increase the power or change the characteristics and functions of the original design without authorization.

The use of low-power radio frequency equipment must not affect flight safety and interfere with legal communications: when the system detects interference, immediately stop using it until there is no interference.

The aforementioned legal communication refers to the wireless communication operated in accordance with the provisions of the Telecommunications Management Law. Low-power radio frequency equipment needs to endure the interference of legal communication or industrial, scientific and medical radio wave radiation electrical equipment.

# Customer Information

## SUNA TRAFFIC CHANNEL – TERMS AND CONDITIONS

By activating, using and/or accessing the SUNA Traffic Channel, SUNA Predictive or other content or material provided by Intelematics (together, **SUNA Products and/or Services**), you must accept certain terms and conditions. The following is a brief summary of the terms and conditions that apply to you. To view the full terms and conditions relevant to your use of the SUNA Products and/or Services, please consult:

Website
<a href="http://www.sunattraffic.com.au/termsandconditions/">www.sunattraffic.com.au/termsandconditions/</a>

### 1. Acceptance

By using SUNA Products and/or Services, you will be deemed to have accepted and agreed to be bound by the terms and conditions fully detailed at:

Website
<a href="http://www.sunattraffic.com.au/termsandconditions/">www.sunattraffic.com.au/termsandconditions/</a>

### 2. Intellectual Property

SUNA Products and/or Services are for your personal use. You may not record, or retransmit the content, nor use the content in association with any other traffic information or route guidance service or device not approved by Intelematics. You obtain no right of ownership in any Intellectual Property Rights (including copyright) in the data that is used to provide SUNA Products and/or Services.

### 3. Appropriate Use

SUNA Products and/or Services are intended as an aid to personal motoring and travel planning, and do not provide comprehensive or accurate information on all occasions. On occasions, you may experience additional delay as a result of using SUNA Products and/or Services. You acknowledge that it is not intended, or suitable, for use in applications where time of arrival or driving directions may impact the safety of the public or yourself.

### 4. Use of SUNA Products and Services while driving

You, and other authorized drivers of the vehicle in which SUNA Products and/or Services are available or installed and active, remain at all times responsible for observing all relevant laws and codes of safe driving. In particular, you agree to only actively operate SUNA Products and/or Services when the Vehicle is at a complete stop and it is safe to do so.

### 5. Service Continuity and Reception of the SUNA Traffic Channel

We will use reasonable endeavors to provide the SUNA Traffic Channel 24 hours a day, 365 days a year. The SUNA Traffic Channel may occasionally be unavailable for technical reasons or for planned maintenance. We will try to perform maintenance at times when congestion is light. We reserve the right to withdraw SUNA Products and/or Services at any time.

Also, we cannot assure the uninterrupted reception of the SUNA Traffic Channel RDS-TMC signal at any particular location.

### 6. Limitation of Liability

Neither Intelematics (nor its suppliers or the manufacturer of your device (the **"Suppliers"**)) shall be liable to you or to any third party for any damages either direct, indirect, incidental, consequential or otherwise arising out of the use of or inability to use SUNA Products and/or

# Customer Information

---

Services even if Intelematics or a Supplier has been advised of the possibility of such damages. You also acknowledge that neither Intelematics nor any Supplier guarantees nor make any warranties that relate to the availability, accuracy or completeness of SUNA Products and/or Services, and to the extent which it is lawful to do so, both Intelematics and each Supplier excludes any warranties which might otherwise be implied by any State or Federal legislation in relation to SUNA Products and/or Services.

## **7. Please Note**

Great care has been taken in preparing this manual. Constant product development may mean that some information is not entirely up-to-date. The information in this document is subject to change without notice.

# Appendices

## ELECTROMAGNETIC COMPATIBILITY



**WARNING:** Do not place objects or mount equipment on or near the airbag cover, on the side of the front or rear seatbacks, or in areas that may come into contact with a deploying airbag. Failure to follow these instructions may increase the risk of personal injury in the event of a crash.



**WARNING:** Do not fasten antenna cables to vehicle wiring, fuel pipes and brake pipes.



**WARNING:** Keep antenna and power cables at least 4 in (10 cm) from any electronic modules and airbags.

**Note:** We test and certify your vehicle to meet electromagnetic compatibility legislation. It is your responsibility to make sure that any equipment an authorized dealer installs on your vehicle complies with applicable local legislation and other requirements. Installation of some aftermarket electronic devices could degrade the performance of vehicle functions, which use radio frequency signals such as broadcast radio receiver, tire pressure monitoring system, push button start, **Bluetooth®** connectivity or satellite navigation.

**Note:** Any radio frequency transmitter equipment in your vehicle (such as cellular telephones and amateur radio transmitters) must keep to the parameters in the following illustrations and table. We do not provide any other special provisions or conditions for installations or use.

### Car/SUV

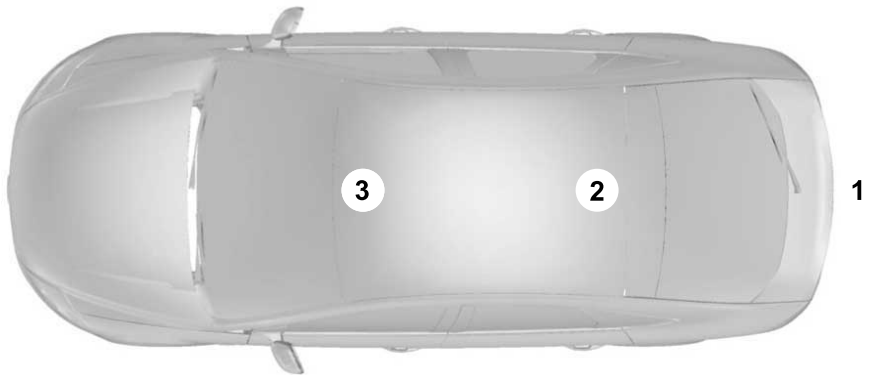

# Appendices

---

## Van



## Truck

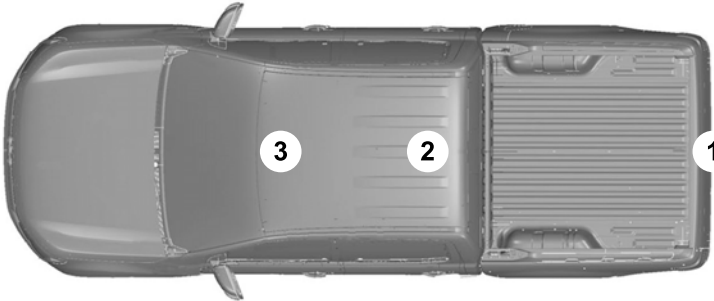

# Appendices

---

<b>Frequency Band MHz</b>	<b>Maximum Output Power Watt (Peak RMS)</b>	<b>Antenna Positions</b>
1-30	50	1
50-54	50	2, 3
68-88	50	2, 3
142-176	50	2, 3
380-512	50	2, 3
806-870	10	2, 3





# Index

## 1

12V Battery.....	439
Changing the 12V Battery.....	439
Charging the 12V Battery.....	439
12V Battery – Troubleshooting.....	439
12V Battery – Information Messages.....	440
12V Battery – Warning Lamps.....	439

## 3

360 Degree Camera.....	263
360 Degree Camera Settings.....	265
360 Degree Camera Guide Lines.....	264
360 Degree Camera Limitations.....	263
360 Degree Camera Precautions.....	263
360 Degree Camera Settings.....	265
Switching the 360 Degree Camera On and Off.....	265
Switching the 360 Degree Camera View.....	266

## 4

4WD	
See: Four-Wheel Drive.....	231

## 9

911 Assist.....	65
-----------------	----

## A

### A/C

See: Climate Control - Vehicles With: 12.3 Inch Screen.....	150
See: Climate Control - Vehicles With: 15 Inch Screen.....	155

About This Publication.....	21
-----------------------------	----

### ABS

See: Brakes.....	236
------------------	-----

Accessing Apps.....	538
---------------------	-----

Accessing Feature Drawers.....	517
--------------------------------	-----

Accessing Navigation.....	545
---------------------------	-----

Accessing the Passive Key Backup Position.....	195
--	-----

Accessing the Trip Computer.....	146
----------------------------------	-----

Accessories.....	558
------------------	-----

AC Charging.....	208
------------------	-----

Connecting the Charger.....	208
-----------------------------	-----

Stopping Charging.....	210
------------------------	-----

Active Park Assist.....	267
-------------------------	-----

Active Park Assist – Troubleshooting.....	269
---	-----

Active Park Assist Precautions.....	267
-------------------------------------	-----

Active Park Assist – Troubleshooting.....	269
---	-----

Active Park Assist – Frequently Asked Questions.....	269
--	-----

Active Park Assist – Information Messages.....	269
--	-----

Adaptive Cruise Control.....	273
------------------------------	-----

Adaptive Cruise Control – Troubleshooting.....	285
--	-----

Intelligent Adaptive Cruise Control.....	283
--	-----

Lane Centering.....	280
---------------------	-----

Adaptive Cruise Control Automatic Cancellation.....	276
---	-----

Adaptive Cruise Control Indicators.....	279
---	-----

Adaptive Cruise Control Limitations.....	274
--	-----

Adaptive Cruise Control Precautions.....	273
--	-----

Adaptive Cruise Control – Troubleshooting.....	285
--	-----

Adaptive Cruise Control – Information Messages.....	285
---	-----

Adaptive Front Lighting.....	125
------------------------------	-----

How Does Adaptive Front Lighting Work.....	125
--	-----

Switching Adaptive Front Lighting On and Off.....	126
---	-----

Adjustable Pedals.....	109
------------------------	-----

Adjusting the Exterior Mirrors.....	132
-------------------------------------	-----

Adjusting the Headlamps.....	440
------------------------------	-----

Adjusting the Instrument Panel Lighting Brightness.....	128
---	-----

Adjusting the Integrated Trailer Brake Controller Mode.....	360
---	-----

Adjusting the Luggage Compartment Load Floor.....	340
---	-----

Adjusting the Map.....	545
------------------------	-----

Changing the Format of the Map.....	545
-------------------------------------	-----

Zooming the Map In and Out.....	545
---------------------------------	-----

Adjusting the Pedals.....	109
---------------------------	-----

Adjusting the Seatbelt Height.....	50
------------------------------------	----

# Index

Adjusting the Seatbelt Length.....	50
Adjusting the Seatbelts During Pregnancy.....	50
Adjusting the Sound Settings.....	493
Adjusting the Steering Wheel - Vehicles With: Manual Adjustable Steering Column.....	107
Adjusting the Steering Wheel - Vehicles With: Power Adjustable Steering Column.....	107
Adjusting the Volume.....	493
Aid Mode.....	299
How Does Aid Mode Work.....	300
What Is Aid Mode.....	299
Airbag Precautions.....	57
Airbags.....	55
Front Passenger Sensing System.....	59
Air Conditioning See: Climate Control - Vehicles With: 12.3 Inch Screen.....	150
See: Climate Control - Vehicles With: 15 Inch Screen.....	155
Air Conditioning System Capacity and Specification.....	481
Alert and Aid Mode.....	300
How Does Alert and Aid Mode Work.....	300
What Is Alert and Aid Mode.....	300
Alert Mode.....	299
Adjusting the Steering Wheel Vibration Intensity.....	299
How Does Alert Mode Work.....	299
What Is Alert Mode.....	299
Alexa Built-In.....	524
Alexa Built-In Requirements.....	524
Alexa Built-In Settings - Vehicles With: 12.3 Inch Screen.....	525
Alexa Built-In Settings - Vehicles With: 15 Inch Screen.....	525
AM/FM Radio.....	494
AM/FM Radio Limitations.....	494
Selecting a Radio Station.....	494
Ambient Lighting.....	128
Adjusting Ambient Lighting.....	128
Switching Ambient Lighting On and Off.....	128
Anti-Lock Braking System.....	236
Anti-Lock Braking System Limitations.....	236
Anti-Theft Alarm System.....	101
Arming the Anti-Theft Alarm System.....	102
Disarming the Anti-Theft Alarm System.....	102
How Does the Anti-Theft Alarm System Work.....	101
What Are the Inclination Sensors.....	102
What Are the Interior Sensors.....	101
What Is the Anti-Theft Alarm System.....	101
What Is the Battery Backup Alarm.....	102
What Is the Perimeter Alarm.....	101
Anti-Theft Alarm System Settings.....	102
Setting the Alarm Security Level.....	102
Switching Ask on Exit On and Off.....	102
What are the Alarm Security Levels.....	102
What Is Ask on Exit.....	102
Appendices.....	625
Applying the Electric Parking Brake.....	239
Applying the Electric Parking Brake in an Emergency.....	239
App Precautions.....	538
App Requirements.....	538
Apps.....	538
Audio System.....	492
AM/FM Radio.....	494
Audio System – Troubleshooting.....	499
Digital Radio.....	495
Satellite Radio.....	496
Audio System Precautions.....	492
Audio System – Troubleshooting.....	499
Audio System – Information Messages.....	499
Auto-Dimming Exterior Mirror.....	133
What Is the Auto-Dimming Exterior Mirror.....	133
Auto-Dimming Interior Mirror.....	131
Auto-Dimming Interior Mirror Limitations.....	131
What Is the Auto-Dimming Interior Mirror.....	131
Auto Hold.....	247
Auto Hold Indicators.....	248
Autolamps.....	115
Autolamp Settings.....	115
What Are Autolamps.....	115
Autolock.....	85
Autolock Requirements.....	85

# Index

What Is Autolock.....	85
Automatically Releasing the Electric Parking Brake.....	239
Automatic Crash Shutoff.....	422
Re-Enabling Your Vehicle.....	422
What Is Automatic Crash Shutoff.....	422
Automatic Emergency Braking.....	317
Switching Automatic Emergency Braking On and Off.....	317
What Is Automatic Emergency Braking.....	317
Automatic High Beam Control.....	119
Automatic High Beam Control Indicators.....	121
Automatic High Beam Control Limitations.....	120
Automatic High Beam Control Precautions.....	120
Automatic High Beam Control Requirements.....	120
How Does Automatic High Beam Control Work.....	119
Overriding Automatic High Beam Control.....	121
Switching Automatic High Beam Control On and Off.....	121
Automatic High Beam Control – Troubleshooting.....	122
Automatic High Beam Control – Information Messages.....	122
Automatic Locking Mode.....	49
Disengaging Automatic Locking Mode.....	49
Engaging Automatic Locking Mode.....	49
What Is Automatic Locking Mode.....	49
When to Use Automatic Locking Mode.....	49
Automatic Return to Park (P).....	229
Automatic Return to Park (P) Limitations.....	229
How Does Automatic Return to Park (P) Work.....	229
What Is Automatic Return to Park (P).....	229
Auto Mode.....	152
Auto Mode Indicators.....	152
Switching Auto Mode On and Off.....	152
Switching Dual Mode On and Off.....	153
Autounlock.....	85
Autounlock Requirements.....	85
Switching Autounlock On and Off.....	85
What Is Autounlock.....	85
Autowipers.....	110
Adjusting the Sensitivity of the Rain Sensor.....	111
Autowipers Settings.....	110
What Are Autowipers.....	110
<b>B</b>	
Beginning a Voice Interaction.....	518
Blind Spot Information System.....	304
Blind Spot Information System – Troubleshooting.....	308
Blind Spot Information System With Trailer Coverage.....	306
Blind Spot Information System Indicators.....	307
Blind Spot Information System Limitations.....	304
Blind Spot Information System Precautions.....	304
Blind Spot Information System Requirements.....	304
Blind Spot Information System – Troubleshooting.....	308
Blind Spot Information System – Information Messages.....	308
Blind Spot Information System With Trailer Coverage.....	306
Blind Spot Information System With Trailer Coverage Limitations.....	306
Selecting a Trailer.....	307
Setting a Trailer Length.....	306
What Is Blind Spot Information System with Trailer Coverage.....	306
BlueCruise Alerts.....	291
BlueCruise Automatic Cancellation.....	291
BlueCruise.....	288
BlueCruise – Troubleshooting.....	292
BlueCruise Indicators.....	292
BlueCruise Limitations.....	289
BlueCruise Precautions.....	288
BlueCruise Requirements.....	289

# Index

BlueCruise Settings - Vehicles With: 12.3 Inch Screen.....	290	Center Display Precautions.....	513
BlueCruise Settings - Vehicles With: 15 Inch Screen.....	290	Changing a Flat Tire.....	472
BlueCruise – Troubleshooting.....	292	Changing a Road Wheel.....	472
BlueCruise – Information Messages.....	292	Changing the Language.....	144
Bluetooth®.....	536	Changing the Measurement Unit.....	144
Body Control Module Fuse Box.....	432	Changing the Remote Control Battery.....	68
Accessing the Body Control Module Fuse Box.....	432	Changing the Temperature Unit.....	144
Identifying the Fuses in the Body Control Module Fuse Box.....	432	Changing the Tire Pressure Unit.....	144
Locating the Body Control Module Fuse Box.....	432	Changing the Vehicle Wi-Fi Hotspot Name or Password.....	488
Bonnet Lock		Charge Port Indicators.....	207
See: Opening and Closing the Hood.....	436	Charging a Device.....	182
Booster Seats.....	44	Charging a Wireless Device.....	191
Brake Coach.....	143	Charging Equipment.....	199
Brake Fluid Specification.....	237	Charging Your Vehicle.....	199
Brake Over Accelerator.....	236	AC Charging.....	208
Brake Precautions.....	236	Charging Your Vehicle – Troubleshooting.....	220
Brakes.....	236	DC Charging.....	211
Anti-Lock Braking System.....	236	Charging Your Vehicle Hints.....	219
Brakes – Troubleshooting.....	237	Charging Your Vehicle Precautions.....	199
Brakes – Troubleshooting.....	237	Charging Your Vehicle – Troubleshooting.....	220
Brakes – Frequently Asked Questions.....	238	Charging Your Vehicle – Frequently Asked Questions.....	221
Brakes – Warning Lamps.....	237	Charging Your Vehicle – Information Messages.....	220
Breaking-In.....	415	Charging Your Vehicle – Warning Lamps.....	220
<b>C</b>		Checking MyKey System Status.....	78
Calculating Payload.....	331	Checking the Brake Fluid.....	236
Calculating the Load Limit.....	331	Checking the Coolant.....	437
Canceling the Set Speed.....	272	Checking the Seatbelts.....	52
Capacities and Specifications.....	480	Checking the Tire Pressures.....	461
Cargo Lamps.....	128	Checking the Wiper Blades.....	111
Switching the Cargo Lamps On and Off.....	128	Children and Airbags.....	58
Center Console Work Surface.....	190	Child Restraint Anchor Points.....	37
Center Console Work Surface – Troubleshooting.....	190	Locating the Child Restraint Lower Anchor Points.....	37
Center Console Work Surface – Troubleshooting.....	190	Locating the Child Restraint Top Tether Anchor Points.....	38
Center Console Work Surface – Information Messages.....	190	What Are the Child Restraint Anchor Points.....	37
Center Display Limitations.....	513	Child Restraints.....	38
Center Display Overview.....	513	Child Restraint Position Information.....	38
		Child Restraints Recommendation.....	39

# Index

Child Safety.....	36	Closing the Tailgate.....	95
Child Restraint Anchor Points.....	37	Closing the Tailgate From Inside Your Vehicle.....	95
Child Restraints.....	38	Closing the Tailgate From Outside Your Vehicle.....	95
Installing Child Restraints.....	39	Closing the Tailgate Using the Remote Control.....	96
Child Safety Locks.....	46	Cold Weather Precautions.....	415
Child Safety Precautions.....	36	Connected Navigation.....	545
Cleaning Products.....	442	Connected Vehicle.....	485
Cleaning the Exterior.....	442	Connected Vehicle – Troubleshooting.....	486
Cleaning Camera Lenses and Sensors.....	444	Connecting the Vehicle to a Mobile Network.....	485
Cleaning Chrome, Aluminium or Stainless Steel.....	443	Connected Vehicle Data.....	28
Cleaning Headlamps and Rear Lamps.....	442	Connected Vehicle Limitations.....	485
Cleaning Stripes or Graphics.....	443	Connected Vehicle Requirements.....	485
Cleaning the Exterior Precautions.....	442	Connected Vehicle – Troubleshooting.....	486
Cleaning the Underbody.....	444	Connected Vehicle – Frequently Asked Questions.....	486
Cleaning Wheels.....	443	Connecting a Bluetooth® Device.....	536
Cleaning Windows and Wiper Blades.....	443	Connecting a Trailer.....	348
Cleaning the Interior.....	444	Connecting a Trailer – Troubleshooting.....	351
Cleaning Carpets and Floor Mats.....	445	Hitches.....	348
Cleaning Displays and Screens.....	444	Connecting a Trailer Precautions.....	348
Cleaning Fabric.....	444	Connecting a Trailer – Troubleshooting.....	351
Cleaning Leather.....	445	Connecting a Trailer – Information Messages.....	351
Cleaning Moonroof Tracks.....	447	Connecting the Vehicle to a Mobile Network.....	485
Cleaning Plastic.....	444	Connecting FordPass to the Modem.....	485
Cleaning Seatbelts.....	446	Enabling and Disabling the Modem.....	485
Cleaning the Instrument Panel.....	444	What Is the Modem.....	485
Cleaning the Luggage Compartment.....	446	Connecting the Vehicle to a Wi-Fi Network - Vehicles With: 12.3 Inch Screen.....	486
Cleaning Vinyl.....	445	Connecting the Vehicle to a Wi-Fi Network - Vehicles With: 15 Inch Screen.....	486
Clearing All MyKeys.....	77	Connecting Your Phone.....	527
Climate Control.....	150	Contacting Us.....	19
Auto Mode.....	152	Cooling System Capacity and Specification.....	480
Driver Focused Mode.....	153	Crash and Breakdown Information.....	418
Climate Control Hints.....	153	Automatic Crash Shutoff.....	422
Closing the Frunk.....	336		
Closing the Frunk from Inside Your Vehicle.....	336		
Closing the Frunk from Outside Your Vehicle.....	336		
Closing the Frunk Using the Remote Control.....	337		
Frunk Obstacle Detection.....	337		
Stopping the Frunk Movement.....	337		
Using the Frunk Emergency Release.....	338		

# Index

Jump Starting the Vehicle.....	420
Post-Crash Alert System.....	421
Post Impact Braking.....	422
Recovery Towing.....	422
Crash Sensors and Airbag Indicator.....	62
Creating a MyKey.....	77
Creating a Personal Profile.....	543
Creating a Vehicle Wi-Fi Hotspot.....	488
Cross Traffic Alert.....	309
Cross Traffic Alert – Troubleshooting.....	311
Cross Traffic Alert Indicators.....	311
Cross Traffic Alert Limitations.....	309
Cross Traffic Alert Precautions.....	309
Cross Traffic Alert – Troubleshooting.....	311
Cross Traffic Alert – Information Messages.....	311
Cruise Control.....	271
Cruise Control Indicators.....	272
Cup Holders.....	192
Cup Holder Precautions.....	192
Customer Information.....	565
Radio Frequency Certification Labels.....	568
Customizing the Instrument Cluster Display.....	143
<b>D</b>	
Data Privacy.....	26
DC Charging.....	211
Connecting the Charger.....	211
Stopping Charging.....	212
Department of Transportation Uniform Tire Quality Grades.....	450
Deploying and Stowing the Power Running Boards.....	106
Digital Radio.....	495
Digital Radio Indicators.....	496
Digital Radio Limitations.....	495
How Does Digital Radio Work.....	495
Switching Digital Radio Reception On and Off.....	496
What Is Digital Radio.....	495
Directing the Flow of Air.....	151
Disposing of Airbags.....	63
Distance Alert.....	317
Adjusting the Sensitivity of Distance Alert.....	317
What Is Distance Alert.....	317
Distance Indication.....	316
Distance Indication Indicator.....	317
Switching Distance Indication On and Off.....	317
What Is Distance Indication.....	316
Doors and Locks Audible Warnings.....	86
Doors and Locks.....	84
Autolock.....	85
Autounlock.....	85
Doors and Locks – Troubleshooting.....	86
Mislock.....	85
Operating the Doors From Inside Your Vehicle.....	84
Operating the Doors From Outside Your Vehicle.....	84
Doors and Locks – Troubleshooting.....	86
Doors and Locks – Frequently Asked Questions.....	87
Doors and Locks – Information Messages.....	86
Doors and Locks – Warning Lamps.....	86
Drive Mode Control.....	294
Drive Mode Control – Troubleshooting.....	295
Drive Modes.....	294
Drive Mode Control – Troubleshooting.....	295
Drive Mode Control – Frequently Asked Questions.....	295
Drive Mode Control – Warning Lamps.....	295
Drive Modes.....	294
Normal.....	294
Off-Road.....	295
Sport.....	295
Tow/Haul.....	295
Driver Alert.....	322
Driver Alert – Troubleshooting.....	323
Driver Alert Limitations.....	322
Driver Alert Precautions.....	322
Driver Alert – Troubleshooting.....	323
Driver Alert – Information Messages.....	323

# Index

Driver Focused Mode.....	153	Electronic Locking Differential Indicators.....	234
Driver Focused Mode Limitations.....	153	Electronic Locking Differential Precautions.....	233
How Does Driver Focused Mode Work.....	153	Electronic Locking Differential – Troubleshooting.....	235
Switching Driver Focused Mode On and Off.....	153	Electronic Locking Differential – Information Messages.....	235
Driver Identification.....	553	Emergency Call Limitations.....	66
Driver Identification – Troubleshooting.....	553	Emergency Call Requirements.....	65
Driver Identification – Troubleshooting.....	553	Emergency Call System Data.....	29
Driver Identification – Information Messages.....	553	Emergency Towing – Vehicles With: 12.3 Inch Screen.....	425
Driving Hints.....	413	Emergency Towing – Vehicles With: 15 Inch Screen.....	425
Electric Vehicle.....	416	Enabling Apps on an Android Device.....	538
Off-Road Driving.....	413	Enabling Apps on an iOS Device.....	538
Driving on Snow and Ice.....	415	Enabling or Disabling Personal Profiles.....	542
<b>E</b>		Enabling Remote Start.....	148
Easy Entry and Exit.....	91	End User License Agreement.....	599
Electric Motor.....	227	Entering a Parallel Parking Space.....	267
Automatic Return to Park (P).....	229	Entering a Perpendicular Parking Space.....	268
Selector Positions.....	227	Evasive Steering Assist.....	318
Temporary Neutral Mode.....	228	Evasive Steering Assist Limitations.....	318
Electric Motor Precautions.....	227	Switching Evasive Steering Assist On and Off.....	318
Electric Motor Temperature Gauge.....	138	What Is Evasive Steering Assist.....	318
Electric Parking Brake Audible Warning.....	240	Event Data.....	27
Electric Parking Brake.....	239	Exiting a Parking Space.....	268
Electric Parking Brake – Troubleshooting.....	240	Extending the Remote Start Duration.....	149
Electric Parking Brake – Troubleshooting.....	240	Exterior Bulbs.....	441
Electric Parking Brake – Information Messages.....	241	Exterior Bulb Specification Chart.....	441
Electric Parking Brake – Warning Lamps.....	240	Exterior Lamps.....	115
Electric Power Steering.....	253	Exterior Lamp Audible Warning.....	117
Electric Power Steering Precautions.....	253	Exterior Lamp Indicators.....	117
Electric Vehicle.....	416	Switching the Cargo Lamps On.....	117
Driving in Cold Weather.....	416	Switching the Daytime Running Lamps On and Off.....	116
Maximizing Your Driving Range.....	416	Switching the Spot Lamps On and Off.....	117
Electromagnetic Compatibility.....	625	Switching the Turn Signal Lamps On and Off.....	115
Electronic Locking Differential.....	233	Exterior Lighting Control.....	114
Electronic Locking Differential – Troubleshooting.....	235		

# Index

Exterior Lighting.....	114
Adaptive Front Lighting.....	125
Autolamps.....	115
Automatic High Beam Control.....	119
Automatic High Beam Control – Troubleshooting.....	122
Exterior Lamps.....	115
Exterior Zone Lighting.....	117
Glare Free Lighting.....	122
Glare Free Lighting – Troubleshooting.....	125
Headlamps.....	114
Headlamps – Troubleshooting.....	114
Exterior Mirrors.....	132
Auto-Dimming Exterior Mirror.....	133
Exterior Zone Lighting.....	117
Exterior Zone Lighting Settings.....	119
Using the Exterior Zone Lighting.....	117
What Is Exterior Zone Lighting.....	117
<b>F</b>	
Fastening and Unfastening the Seatbelts.....	48
Feature Bar.....	514
Flat Tire See: Changing a Flat Tire.....	472
Floor Mats.....	417
Folding the Exterior Mirrors - Vehicles With: Manual Folding Mirrors.....	132
Folding the Exterior Mirrors - Vehicles With: Power Folding Mirrors.....	132
Foot Pedals See: Adjusting the Pedals.....	109
Ford Protect.....	559
Four-Wheel Drive.....	231
Four-Wheel Drive – Troubleshooting.....	231
Four-Wheel Drive Limitations.....	231
Four-Wheel Drive Precautions.....	231
Four-Wheel Drive – Troubleshooting.....	231
Four-Wheel Drive – Information Messages.....	232
Four-Wheel Drive – Warning Lamps.....	231
Front Exterior.....	34
Front Parking Aid.....	256
Front Parking Aid Audible Warnings.....	256
Front Parking Aid Limitations.....	256
Locating the Front Parking Aid Sensors.....	256
What Is the Front Parking Aid.....	256
Front Passenger Sensing System.....	59
Front Passenger Sensing System Indicators.....	61
Front Passenger Sensing System Precautions.....	61
How Does the Front Passenger Sensing System Work.....	59
What Is the Front Passenger Sensing System.....	59
Front Seat Precautions.....	162
Front Seats.....	162
Heated Seats.....	169
Manual Seats.....	163
Massage Seats.....	168
Power Seats.....	165
Ventilated Seats.....	170
Fuse Precautions.....	427
Fuses.....	427
Body Control Module Fuse Box.....	432
Fuses – Troubleshooting.....	435
Under Hood Fuse Box.....	427
Fuses – Troubleshooting.....	435
Fuses – Frequently Asked Questions.....	435
<b>G</b>	
Garage Door Opener Additional Assistance.....	180
Garage Door Opener.....	177
Garage Door Opener Introduction.....	177
Garage Door Opener Precautions and Frequencies.....	177
General Maintenance Information.....	561
Glare Free Lighting.....	122
Glare Free Lighting Indicators.....	124
Glare Free Lighting Limitations.....	124
Glare Free Lighting Precautions.....	123
Glare Free Lighting Requirements.....	123
How Does Glare Free Lighting Work.....	122
Overriding Glare Free Lighting.....	124
Switching Glare Free Lighting On and Off.....	124



# Index

Glare Free Lighting – Troubleshooting.....	125
Glare Free Lighting – Information Messages.....	125
Glasses Holder.....	193
Locating the Glasses Holder.....	193
Glossary of Tire Terminology.....	456
Glove Compartment.....	192
Locking the Glove Compartment.....	192
Opening the Glove Compartment.....	192
<b>H</b>	
Headlamp Adjusting See: Adjusting the Headlamps.....	440
Headlamps.....	114
Headlamp Indicators.....	114
Using the High Beam Headlamps.....	114
Headlamps – Troubleshooting.....	114
Headlamps – Frequently Asked Questions.....	114
Heated Seats.....	169
Heated Seat Precautions.....	169
Switching the Heated Seats On and Off.....	169
Heating See: Climate Control - Vehicles With: 12.3 Inch Screen.....	150
See: Climate Control - Vehicles With: 15 Inch Screen.....	155
High Voltage Battery Gauge.....	137
High Voltage Battery.....	197
High Voltage Battery – Troubleshooting.....	198
High Voltage Battery Precautions.....	197
High Voltage Battery Temperature Gauge.....	138
High Voltage Battery – Troubleshooting.....	198
High Voltage Battery – Warning Lamps.....	198
High Voltage Battery Vehicle Precautions.....	419
Hill Start Assist.....	246
Hill Start Assist – Troubleshooting.....	246
Hill Start Assist Precautions.....	246
Hill Start Assist – Troubleshooting.....	246
Hill Start Assist – Information Messages.....	246
Hitches.....	348
Hooking Up a Trailer Using a Weight-Distributing Hitch.....	348
Hood Lock See: Opening and Closing the Hood.....	436
Horn.....	108
How Does 911 Assist Work.....	65
How Does Active Park Assist Work.....	267
How Does Adaptive Cruise Control With Stop and Go Work.....	273
How Does Auto Hold Work.....	247
How Does Blind Spot Information System Work.....	304
How Does BlueCruise Work.....	288
How Does Cross Traffic Alert Work.....	309
How Does Drive Mode Control Work.....	294
How Does Driver Alert Work.....	322
How Does Driver Identification Work.....	553
How Does Easy Entry and Exit Work.....	91
How Does Four-Wheel Drive Work.....	231
How Does Hill Start Assist Work.....	246
How Does Intelligent Backup Power Work.....	222
How Does On-Board Scale Work.....	383
How Does Pre-Collision Assist Work.....	312
How Does Reverse Braking Assist Work.....	242
How Does Smart Hitch Work.....	380
How Does Speed Sign Recognition Work.....	324
How Does Stability Control Work.....	251
How Does the 360 Degree Camera Work.....	263
How Does the Electronic Locking Differential Work.....	233
How Does the Lane Keeping System Work.....	297
How Does the Personal Safety System Work.....	54

# Index

How Does the Rear Occupant Alert System Work.....	174
How Does the Safety Canopy™ Work.....	56
How Does the Trailer Reversing Aid Work.....	363
How Does Traction Control Work.....	249
How Does Trailer Backup Assistance Work.....	386
How Does Trailer Hitching Assistance Work.....	377
How Does Trailer Reverse Guidance Work.....	401
How Does Trailer Sway Control Work.....	362
How Do Personal Profiles Work.....	542
How Do the Front Airbags Work.....	55
How Do the Knee Airbags Work.....	56
How Do the Side Airbags Work.....	55
<b>I</b>	
Identifying Fuse Types.....	435
Identifying the Audio Unit.....	492
Identifying the Climate Control Unit.....	150
Inflating the Tires.....	461
Information On Demand Screen.....	515
Information on the Tire Sidewall.....	451
Inspecting the Tire for Damage.....	462
Inspecting the Tire for Wear.....	462
Inspecting the Wheel Valve Stems.....	463
Installing and Removing the Luggage Compartment Cover.....	338
Installing Child Restraints.....	39
Attaching the Rear Seat Tether Strap.....	43
Combining the Seatbelt and Lower Anchors for Attaching Child Restraints.....	43
Installing a Child Restraint in a Center Seat.....	42
Using Lower Anchors and Tethers for Children.....	41
Using Seatbelts.....	39
Using Tether Straps.....	43
Instrument Cluster Display.....	142
Instrument Cluster Display Main Menu.....	142
Instrument Cluster Indicators.....	140
Instrument Cluster.....	136
Instrument Cluster Overview.....	136
Instrument Cluster Warning Lamps.....	138
Instrument Panel - Vehicles With: 12.3 Inch Screen.....	31
Instrument Panel - Vehicles With: 15 Inch Screen.....	32
Integrated Trailer Brake Controller.....	358
Integrated Trailer Brake Controller – Troubleshooting.....	360
Integrated Trailer Brake Controller Precautions.....	358
Integrated Trailer Brake Controller – Troubleshooting.....	360
Integrated Trailer Brake Controller – Frequently Asked Questions.....	361
Integrated Trailer Brake Controller – Information Messages.....	360
Intelligent Adaptive Cruise Control.....	283
Adjusting the Set Speed Tolerance.....	284
How Does Intelligent Adaptive Cruise Control Work.....	283
Intelligent Adaptive Cruise Control Alerts.....	284
Intelligent Adaptive Cruise Control Indicators.....	285
Intelligent Adaptive Cruise Control Limitations.....	283
Intelligent Adaptive Cruise Control Precautions.....	283
Intelligent Adaptive Cruise Control Requirements.....	283
Switching Intelligent Mode On and Off.....	284
Intelligent Backup Power.....	222
Intelligent Backup Power – Troubleshooting.....	225
Intelligent Backup Power Requirements.....	222
Intelligent Backup Power Settings - Vehicles With: 12.3 Inch Screen.....	223
Intelligent Backup Power Settings - Vehicles With: 15 Inch Screen.....	223

# Index

Intelligent Backup Power – Troubleshooting.....	225	Keyless Entry Limitations.....	88
Intelligent Backup Power – Frequently Asked Questions.....	225	Keyless Entry Settings.....	88
Intelligent Backup Power – Information Messages.....	225	Keys and Remote Controls.....	67
Interior Air Quality.....	161	Keys and Remote Controls – Troubleshooting.....	71
Interior Bulbs.....	441	Keys and Remote Controls – Troubleshooting.....	71
Interior Bulb Specification Chart.....	441	Keys and Remote Controls – Information Messages.....	71
Interior Lamp Function.....	127		
Switching the Interior Lamp Function On and Off.....	127	<b>L</b>	
What Is the Interior Lamp Function.....	127	Lane Centering.....	280
Interior Lighting.....	127	How Does Lane Centering Work.....	280
Ambient Lighting.....	128	Lane Centering Alerts.....	282
Cargo Lamps.....	128	Lane Centering Automatic Cancellation.....	282
Interior Lamp Function.....	127	Lane Centering Indicators.....	283
Interior Lighting – Troubleshooting.....	128	Lane Centering Limitations.....	281
Interior Lighting – Troubleshooting.....	128	Lane Centering Precautions.....	281
Interior Lighting – Frequently Asked Questions.....	128	Lane Centering Requirements.....	281
Interior Mirror.....	131	Switching Lane Centering On and Off.....	281
Auto-Dimming Interior Mirror.....	131	Lane Keeping System Indicators.....	300
Interior Mirror Precautions.....	131	Lane Keeping System.....	297
Introduction.....	21	Aid Mode.....	299
		Alert and Aid Mode.....	300
		Alert Mode.....	299
<b>J</b>		Lane Keeping System – Troubleshooting.....	301
Jump Starting the Vehicle.....	420	Lane Keeping System Limitations.....	297
Jump Starting Precautions.....	420	Lane Keeping System Precautions.....	297
Jump Starting the Vehicle.....	421	Lane Keeping System – Troubleshooting.....	301
Preparing the Vehicle.....	420	Lane Keeping System – Frequently Asked Questions.....	302
		Lane Keeping System – Information Messages.....	301
<b>K</b>		Launching or Retrieving a Boat or Personal Watercraft.....	354
Keyless Entry.....	88	Linking or Unlinking a Personal Profile to a Device.....	544
Keyless Entry Keypad.....	89	Linking or Unlinking a Personal Profile to a Remote Control.....	543
Keyless Entry Keypad – Troubleshooting.....	90	Live Traffic.....	545
Keyless Entry Keypad Limitations.....	89	Switching Live Traffic On and Off.....	545
Keyless Entry Keypad Master Access Code.....	89	What Is Live Traffic.....	545
Keyless Entry Keypad Personal Access Codes.....	89	Load Carrying.....	328
Keyless Entry Keypad – Troubleshooting.....	90	Load Carrying Precautions.....	328
Keyless Entry Keypad – Frequently Asked Questions.....	90		

# Index

Loading Your Trailer.....	353
Locating the 360 Degree Cameras.....	263
Locating the Blind Spot Information System Sensors.....	305
Locating the Brake Fluid Reservoir.....	236
Locating the Charge Port.....	207
Locating the Cross Traffic Alert Sensors.....	310
Locating the Keyless Entry Keypad.....	89
Locating the Memory Function Buttons.....	176
Locating the Outlets.....	184
Locating the Power Outlets.....	183
Locating the Pre-Collision Assist Sensors.....	315
Locating the Rear View Camera.....	260
Locating the Safety Compliance Certification Labels.....	329
Locating the Tire label.....	450
Locating the USB Ports.....	181
Locating the Wireless Accessory Charger.....	191
Locating Your Vehicle.....	68
Locking the Rear Window Controls.....	130
Luggage Compartment Anchor Points.....	340
Locating the Luggage Compartment Anchor Points.....	340
Luggage Compartment.....	334
Closing the Frunk.....	336
Luggage Compartment Anchor Points.....	340
Luggage Compartment – Troubleshooting.....	340
Opening the Frunk.....	334
Luggage Compartment Precautions.....	334
Luggage Compartment – Troubleshooting.....	340
Luggage Compartment – Frequently Asked Questions.....	342
Luggage Compartment – Information Messages.....	341
Luggage Compartment – Warning Lamps.....	340

## M

Maintenance.....	436
12V Battery.....	439
12V Battery – Troubleshooting.....	439
Exterior Bulbs.....	441
Interior Bulbs.....	441
Maintenance Precautions.....	436
Making and Receiving a Phone Call.....	529
Manually Dimming the Interior Mirror.....	131
Manually Releasing the Electric Parking Brake.....	239
Manual Seats.....	163
Adjusting the Head Restraint.....	163
Adjusting the Lumbar Support.....	164
Adjusting the Seat Backrest.....	164
Folding the Seats.....	171
Head Restraint Components.....	163
Installing the Head Restraint.....	164
Moving the Seat Backward and Forward.....	164
Removing the Head Restraint.....	164
Unfolding the Seats.....	172
Massage Seats.....	168
Adjusting the Massage Seat Settings.....	168
Massage Seat Limitations.....	168
Memory Function.....	176
Memory Function Precautions.....	176
Mislock.....	85
Mislock Limitations.....	85
Switching Mislock On and Off.....	85
What Is Mislock.....	85
Mobile Communications Equipment.....	598
Mobile Device Data.....	29
Moonroof Bounce-Back.....	135
Overriding Moonroof Bounce-Back.....	135
What Is Moonroof Bounce-Back.....	135
Moonroof.....	134
Moonroof Bounce-Back.....	135
Motorcraft Parts.....	480
Muting the Audio.....	493
MyKey Settings.....	76
Configurable MyKey Settings.....	76
Non-Configurable MyKey Settings.....	76

# Index

MyKey – Troubleshooting.....	78
MyKey – Frequently Asked Questions.....	79
MyKey – Information Messages.....	78
MyKey™.....	76
MyKey Settings.....	76
MyKey – Troubleshooting.....	78

## N

Navigation Map Updates.....	545
Navigation.....	545
Adjusting the Map.....	545
Live Traffic.....	545
Route Guidance.....	547
Setting a Destination.....	545
Waypoints.....	547
Normal Scheduled Maintenance.....	563

## O

Off-Road Driving.....	413
After Driving Your Vehicle Off-Road.....	414
Basic Off-Road Driving Techniques.....	413
Water Wading.....	414
What Is Off-Road Driving.....	413
Onboard Generator Indicators.....	185
Onboard Generator.....	184
Onboard Generator – Troubleshooting.....	188
Onboard Generator Precautions.....	184
Onboard Generator – Troubleshooting.....	188
Onboard Generator – Frequently Asked Questions.....	189
Onboard Generator – Information Messages.....	188
On-Board Scale Limitations.....	383
On-Board Scale.....	383
One Pedal Drive Indicators.....	296
One Pedal Drive Limitations.....	296
One Pedal Drive.....	296
One Pedal Drive Precautions.....	296
Opening and Closing the Hood.....	436
Opening and Closing the Moonroof.....	134
Opening and Closing the Sliding Windows.....	130

Opening and Closing the Sunshade.....	134
Opening and Closing the Windows.....	129
Opening the Frunk.....	334
Opening the Frunk from Inside Your Vehicle.....	334
Opening the Frunk from Outside Your Vehicle.....	335
Opening the Frunk Using the Remote Control.....	335
Setting the Frunk Opening Height.....	335
Opening the Tailgate.....	92
Opening the Tailgate From Inside Your Vehicle.....	95
Opening the Tailgate From Outside Your Vehicle.....	92
Opening the Tailgate Using the Remote Control.....	95
Operating the Doors From Inside Your Vehicle.....	84
Individually Unlocking and Locking the Doors Using the Locking Button.....	84
Opening the Doors From Inside Your Vehicle.....	85
Operating the Doors From Outside Your Vehicle.....	84
Unlocking and Locking the Doors Using the Key Blade.....	84
Unlocking and Locking the Doors Using the Remote Control.....	84
Ordering a Canadian French Owner's Manual.....	566
Overriding Reverse Braking Assist.....	243
Overriding the Set Speed.....	279

## P

Pairing a Charge Station - Vehicles With: 12.3 Inch Screen.....	222
Pairing a Charge Station - Vehicles With: 15 Inch Screen.....	223
Parking Aid Indicators - Vehicles With: 12.3 Inch Screen.....	258
Parking Aid Indicators - Vehicles With: 15 Inch Screen.....	258
Parking Aid Precautions.....	254
Parking Aids.....	254
Front Parking Aid.....	256

# Index

Parking Aids – Troubleshooting.....	259	Playing Media Using Bluetooth®.....	536
Rear Parking Aid.....	255	Playing Media Using the USB Port - Vehicles With: 12.3 Inch Screen.....	181
Side Parking Aid.....	257	Playing Media Using the USB Port - Vehicles With: 15 Inch Screen.....	182
Parking Aids – Troubleshooting.....	259	Playing or Pausing the Audio Source.....	492
Parking Aids – Information Messages.....	259	Post-Crash Alert System.....	421
Passive Anti-Theft System.....	101	How Does the Post-Crash Alert System Work.....	421
How Does the Passive Anti-Theft System.....	101	Post-Crash Alert System Limitations.....	421
Pedestrian Alert System.....	64	Switching the Post-Crash Alert System Off.....	422
Perchlorate.....	597	What Is the Post-Crash Alert System.....	421
Performing a Master Reset.....	555	Post Impact Braking.....	422
Personalized Settings.....	144	How Does Post Impact Braking Work.....	422
Personal Profile Settings.....	544	Overriding Post Impact Braking.....	422
Personal Profiles.....	542	Post Impact Braking Indicators.....	422
Personal Safety System Components.....	54	Post Impact Braking Limitations.....	422
Personal Safety System™.....	54	Power Gauge.....	137
Phone as a Key Limitations.....	72	Powering Off.....	194
Phone as a Key.....	72	Power Outlet.....	183
Phone as a Key – Troubleshooting.....	74	Power Outlet Precautions.....	183
Phone as a Key – Troubleshooting.....	74	Power Running Board Kick Switch.....	105
Phone as a Key – Frequently Asked Questions.....	74	Power Running Board Precautions.....	105
Phone Menu.....	527	Power Running Board Settings.....	105
Phone.....	527	Power Running Boards.....	105
Phone Precautions.....	527	Power Running Boards – Troubleshooting.....	106
Pickup Bed Anchor Points.....	343	Power Running Boards – Troubleshooting.....	106
Installing and Removing the Pickup Bed Tie-Down Cleats.....	343	Power Running Boards – Frequently Asked Questions.....	106
Pickup Bed Anchor Point Load Capacities.....	344	Power Seats.....	165
Pickup Bed Anchor Point Precautions.....	343	Adjusting the Head Restraint.....	165
Pickup Bed.....	343	Adjusting the Lumbar Support.....	168
Pickup Bed Anchor Points.....	343	Adjusting the Seat Backrest.....	166
Pickup Bed Ramps.....	345	Adjusting the Seat Cushion.....	166
Tailgate Anchor Points.....	345	Adjusting the Seat Height.....	167
Pickup Bed Precautions.....	343	Head Restraint Components.....	165
Pickup Bed Ramps.....	345	Installing the Head Restraint.....	166
Installing and Removing the Pickup Bed Ramp Holder.....	346	Moving the Seat Backward and Forward.....	166
Installing and Removing the Pickup Bed Ramps.....	346	Removing the Head Restraint.....	166
Pickup Bed Ramp Precautions.....	345	Pre-Collision Assist Limitations.....	313
Storing the Pickup Bed Ramps.....	347	Pre-Collision Assist Precautions.....	312

# Index

Pre-Collision Assist.....	312	Rear Occupant Alert System	
Automatic Emergency Braking.....	317	Indicators.....	175
Distance Alert.....	317	Rear Occupant Alert System	
Distance Indication.....	316	Limitations.....	174
Evasive Steering Assist.....	318	Rear Occupant Alert System	
Pre-Collision Assist –		Precautions.....	174
Troubleshooting.....	319	Rear Occupant Alert System.....	174
Pre-Collision Assist –		Rear Parking Aid.....	255
Troubleshooting.....	319	Locating the Rear Parking Aid	
Pre-Collision Assist – Frequently Asked		Sensors.....	255
Questions.....	320	Rear Parking Aid Audible Warnings.....	256
Pre-Collision Assist – Information		Rear Parking Aid Limitations.....	255
Messages.....	319	What is the Rear Parking Aid.....	255
Pre-Collision Assist – Warning		Rear Seats.....	171
Lamps.....	319	Heated Seats.....	172
Preparing Your Vehicle for		Manual Seats.....	171
Storage.....	448	Rear View Camera Guide Lines.....	261
Preserving Your High Voltage		Rear View Camera Precautions.....	260
Battery.....	197	Rear View Camera.....	260
Programming a MyKey.....	77	Rear View Camera Settings.....	261
Programming the Garage Door		Rear View Camera Settings.....	261
Opener.....	178	Switching Rear View Camera Delay On and	
Programming the Remote Control.....	70	Off.....	262
Programming Your Phone.....	72	Switching the Rear View Camera	
Properly Adjusting the Driver and Front		View.....	262
Passenger Seats.....	58	Zooming the Rear View Camera In and	
Puncture		Out.....	261
See: Changing a Flat Tire.....	472	Rebooting the Center Display.....	515
<b>R</b>		Recalling a Preset Position.....	176
Radio Frequency Certification		Recovery Towing.....	422
Labels.....	568	Accessing the Front Towing Point.....	422
Blind Spot Information System		Recreationally Towing Your	
Sensors.....	568	Vehicle.....	425
Body Control Module.....	568	Recycling and Disposing of the High	
Cruise Control Module.....	571	Voltage Battery.....	198
Keys and Remote Controls.....	573	Releasing the Electric Parking Brake if	
Passive Anti-Theft System.....	576	the Vehicle Battery Has Run Out of	
Radio Transceiver Module.....	580	Charge.....	240
SYNC.....	582	Remote Control Limitations.....	67
Tire Pressure Monitoring System		Remotely Starting and Stopping the	
Sensors.....	587	Vehicle.....	148
Wireless Accessory Charging Module.....	591	Remote Start Limitations.....	148
Rear Exterior.....	35	Remote Start Precautions.....	148
Rear Occupant Alert System Audible		Remote Start.....	148
Warnings.....	175	Remote Start Settings.....	149
		Removing and Installing the	
		Tailgate.....	92
		Removing the Key Blade.....	68

# Index

Removing Your Vehicle From Storage.....	449
Repairing Minor Paint Damage.....	447
Replacement Parts Recommendation.....	597
Replacing a Lost Key or Remote Control.....	69
Replacing the Cabin Air Filter.....	161
Replacing the Front Wiper Blades.....	111
Reporting Safety Defects in Canada.....	567
Reporting Safety Defects in the United States.....	567
Resetting Ground Fault Detection.....	187
Resetting the Circuit Breaker - Vehicles With: 9.6kW.....	187
Resetting the Stopping Position - Vehicles With: Power Adjustable Steering Column.....	108
Resetting the Trip Computer.....	146
Resetting Tire Pressure Monitoring System.....	467
Restarting the Vehicle After Powering Off.....	194
Resuming the Set Speed.....	272
Reverse Braking Assist Indicators.....	243
Reverse Braking Assist Precautions.....	242
Reverse Braking Assist.....	242
Reverse Braking Assist – Troubleshooting.....	244
Reverse Braking Assist – Troubleshooting.....	244
Reverse Braking Assist – Frequently Asked Questions.....	245
Reverse Braking Assist – Information Messages.....	244
Roadside Assistance.....	418
Rollover Warning.....	565
Route Guidance.....	547
Adjusting the Guidance Prompt Volume.....	547
Canceling Route Guidance.....	547
Repeating an Instruction.....	547
Running-In See: Breaking-In.....	415

## S

Satellite Radio.....	496
Locating the Satellite Radio Identification Number.....	497
Satellite Radio Limitations.....	496
Satellite Radio Settings.....	497
Selecting a Channel.....	497
What Is Satellite Radio.....	496
Saving a Preset Position.....	176
Scheduled Maintenance.....	561
Seatbelt Extensions.....	53
Seatbelt Precautions.....	47
Seatbelt Reminder.....	51
How Does the Seatbelt Reminder Work.....	51
Seatbelt Reminder Audible Warnings.....	52
Seatbelt Reminder Indicators.....	52
Switching the Seatbelt Reminder On and Off.....	52
Seatbelts.....	47
Automatic Locking Mode.....	49
Seatbelt Reminder.....	51
Sensitive Locking Mode.....	49
Security.....	101
Anti-Theft Alarm System.....	101
Anti-Theft Alarm System Settings.....	102
Passive Anti-Theft System.....	101
Security – Troubleshooting.....	103
Security – Troubleshooting.....	103
Security – Frequently Asked Questions.....	104
Security – Information Messages.....	103
Selecting a Drive Mode.....	294
Selecting the Audio Source.....	492
Selector Positions.....	227
Drive (D).....	227
Neutral (N).....	227
Park (P).....	227
Reverse (R).....	227
Sending and Receiving a Text Message.....	530
Sensitive Locking Mode.....	49
How Does Sensitive Locking Mode Work.....	49
What is Sensitive Locking Mode.....	49
Service Data.....	27



# Index

Setting a Destination.....	545	Trailer Sensor Installation.....	388
Setting a Destination Using a Point of Interest.....	547	Setting Up the Trailer Reversing Aid for a Conventional Trailer.....	363
Setting a Destination Using a Predictive Destination.....	547	Calibrating the System.....	365
Setting a Destination Using a Recent Destination.....	547	Configuring the Trailer.....	363
Setting a Destination Using a Saved Destination.....	547	Trailer Sensor Installation.....	365
Setting a Destination Using the Map Screen.....	546	Setting Up Trailer Reverse Guidance for a Conventional Trailer.....	401
Setting a Destination Using the Text Entry Screen.....	545	Applying the Trailer Reverse Aid Sticker.....	402
Setting a Destination Using Trip Planner.....	546	Calibrating the System.....	404
Setting a Memory Preset.....	493	Configuring the Trailer.....	401
Settings Data.....	28	Trailer Sensor Installation.....	403
Setting the Adaptive Cruise Control Gap.....	277	Shifting Your Vehicle Into Gear.....	228
Setting the Adaptive Cruise Control Speed.....	276	Side Parking Aid.....	257
Setting the Blower Motor Speed.....	151	Locating the Side Parking Aid Sensors.....	257
Setting the Charging Schedule and Preferences.....	214	Side Parking Aid Audible Warnings.....	258
Setting the Clock and Date.....	494	Side Parking Aid Limitations.....	257
Setting the Cruise Control Speed.....	271	What is the Side Parking Aid.....	257
Setting the High Voltage Battery Reserve Limit.....	187	Signing In as a Driver.....	553
Setting the Speed Sign Recognition Speed Tolerance - Vehicles With: 12.3 Inch Screen.....	325	Signing Into Your Account - Vehicles With: 12.3 Inch Screen.....	524
Setting the Speed Sign Recognition Speed Tolerance - Vehicles With: 15 Inch Screen.....	325	Signing Into Your Account - Vehicles With: 15 Inch Screen.....	524
Setting the Speed Sign Recognition Speed Warning - Vehicles With: 12.3 Inch Screen.....	325	Sitting in the Correct Position.....	162
Setting the Speed Sign Recognition Speed Warning - Vehicles With: 15 Inch Screen.....	325	Smart Hitch Limitations.....	380
Setting the Temperature.....	151	Smart Hitch.....	380
Setting the Wake Word.....	518	Sounding the Panic Alarm.....	68
Setting Up the Trailer Backup Assistance for a Conventional Trailer.....	386	Speed Control	
Applying the Trailer Reversing Aid Sticker.....	388	See: Cruise Control.....	271
Calibrating the System.....	389	Speedometer.....	137
Configuring the Trailer.....	386	Speed Sign Recognition Indicators.....	324
		Speed Sign Recognition	
		Limitations.....	324
		Speed Sign Recognition	
		Precautions.....	324
		Speed Sign Recognition.....	324
		Speed Sign Recognition - Troubleshooting.....	326
		Speed Sign Recognition - Troubleshooting.....	326
		Speed Sign Recognition - Frequently Asked Questions.....	327
		Speed Sign Recognition - Information Messages.....	326
		Stability Control.....	251

# Index

Starting and Powering Off	
Precautions.....	194
Starting and Powering Off.....	194
Starting and Powering Off –	
Troubleshooting.....	196
Vehicle Power Down Timer.....	195
Starting and Powering Off –	
Troubleshooting.....	196
Starting and Powering Off – Frequently	
Asked Questions.....	196
Starting the Vehicle.....	194
Status Bar.....	513
Steering.....	253
Electric Power Steering.....	253
Steering – Troubleshooting.....	253
Steering – Troubleshooting.....	253
Steering – Information Messages.....	253
Steering Wheel.....	30
Storage.....	192
Cup Holders.....	192
Glasses Holder.....	193
Glove Compartment.....	192
Storing Your Vehicle.....	448
Stowing the Selector Lever - Vehicles	
With: Console Shift.....	229
Sunroof	
See: Moonroof.....	134
Switching Active Park Assist On and	
Off.....	267
Switching Adaptive Cruise Control On	
and Off.....	275
Switching Air Conditioning On and	
Off.....	150
Switching All of the Interior Lamps On	
and Off.....	127
Switching Android Auto On and	
Off.....	539
Switching Apple CarPlay On and	
Off.....	539
Switching Auto Hold On and Off -	
Vehicles With: 12.3 Inch Screen.....	247
Switching Auto Hold On and Off -	
Vehicles With: 15 Inch Screen.....	247
Switching Blind Spot Information	
System On and Off - Vehicles With:	
12.3 Inch Screen.....	304
Switching Blind Spot Information	
System On and Off - Vehicles With: 15	
Inch Screen.....	305
Switching BlueCruise On and Off.....	290
Switching Climate Control On and	
Off.....	150
Switching Cross Traffic Alert On and Off	
- Vehicles With: 12.3 Inch Screen.....	310
Switching Cross Traffic Alert On and Off	
- Vehicles With: 15 Inch Screen.....	310
Switching Cruise Control On and	
Off.....	271
Switching Defrost On and Off.....	150
Switching Driver Alert On and Off -	
Vehicles With: 12.3 Inch Screen.....	323
Switching Driver Alert On and Off -	
Vehicles With: 15 Inch Screen.....	323
Switching Easy Entry and Exit On and	
Off.....	91
Switching From Adaptive Cruise Control	
to Cruise Control - Vehicles With: 12.3	
Inch Screen.....	280
Switching From Adaptive Cruise Control	
to Cruise Control - Vehicles With: 15	
Inch Screen.....	280
Switching Maximum Cooling On and	
Off.....	151
Switching Maximum Defrost On and	
Off.....	150
Switching One Pedal Drive On and Off -	
Vehicles With: 12.3 Inch Screen.....	296
Switching One Pedal Drive On and Off -	
Vehicles With: 15 Inch Screen.....	296
Switching Parking Aid On and Off -	
Vehicles With: 12.3 Inch Screen.....	255
Switching Parking Aid On and Off -	
Vehicles With: 15 Inch Screen.....	254
Switching Pre-Collision Assist On and	
Off - Vehicles With: 12.3 Inch	
Screen.....	314
Switching Pre-Collision Assist On and	
Off - Vehicles With: 15 Inch	
Screen.....	314
Switching Rear Occupant Alert System	
On and Off - Vehicles With: 12.3 Inch	
Screen.....	174

# Index

Switching Rear Occupant Alert System On and Off - Vehicles With: 15 Inch Screen.....	175
Switching Recirculated Air On and Off.....	150
Switching Repeat Mode On and Off.....	493
Switching Reverse Braking Assist On and Off - Vehicles With: 12.3 Inch Screen.....	243
Switching Reverse Braking Assist On and Off - Vehicles With: 15 Inch Screen.....	243
Switching Shuffle Mode On and Off.....	493
Switching Stability Control On and Off.....	252
Switching Text Message Notification On and Off.....	531
Switching the Audio Unit On and Off.....	492
Switching the Display On and Off.....	495
Switching the Electric Heater On and Off.....	156
Switching the Electronic Locking Differential On and Off - 4x4.....	234
Switching the Front Interior Lamps On and Off.....	127
Switching the Hazard Flashers On and Off.....	420
Switching the Heated Mirrors On and Off.....	151
Switching the Heated Rear Window On and Off.....	151
Switching the Heated Steering Wheel On and Off - Vehicles With: 12.3 Inch Screen.....	108
Switching the Heated Steering Wheel On and Off - Vehicles With: 15 Inch Screen.....	108
Switching the Lane Keeping System Mode - Vehicles With: 12.3 Inch Screen.....	298
Switching the Lane Keeping System Mode - Vehicles With: 15 Inch Screen.....	299
Switching the Lane Keeping System On and Off.....	298
Switching the Outlets On and Off - Vehicles With: 12.3 Inch Screen.....	186
Switching the Outlets On and Off - Vehicles With: 15 Inch Screen.....	186
Switching the Rear Interior Lamps On and Off.....	127
Switching the Trailer Reversing Aid On and Off.....	366
Switching Traction Control On and Off.....	249
Switching Trailer Backup Assistance On and Off.....	390
Switching Trailer Hitching Assistance On and Off.....	378
Switching Trailer Reverse Guidance On and Off.....	404
Switching Trailer Sway Control On and Off - Vehicles With: 12.3 Inch Screen.....	362
Switching Trailer Sway Control On and Off - Vehicles With: 15 Inch Screen.....	362
Symbols Glossary.....	23
Symbols Used on Your Vehicle.....	23
<b>T</b>	
Tailgate Anchor Points.....	345
Locating the Tailgate Anchor Points.....	345
Tailgate Anchor Point Load Capacities.....	345
Tailgate Precautions.....	92
Tailgate Step.....	93
Accessing the Tailgate Step.....	93
Stowing the Tailgate Step.....	94
Tailgate.....	92
Closing the Tailgate.....	95
Opening the Tailgate.....	92
Tailgate Step.....	93
Tailgate - Troubleshooting.....	99
Tailgate - Troubleshooting.....	99
Tailgate - Frequently Asked Questions.....	100
Tailgate - Information Messages.....	99
Tailgate Work Surface.....	94
Technical Specifications	
See: Capacities and Specifications.....	480

# Index

Temporary Neutral Mode.....	228	Towing Your Vehicle –	
Entering Temporary Neutral Mode.....	228	Troubleshooting.....	426
Exiting Temporary Neutral Mode.....	229	Towing Your Vehicle – Information	
How Does Temporary Neutral Mode		Messages.....	426
Work.....	228	Traction Control Indicator.....	249
Temporary Neutral Mode		Traction Control.....	249
Limitations.....	228	Traction Control – Troubleshooting.....	250
What Is Temporary Neutral Mode.....	228	Traction Control –	
The Better Business Bureau Auto Line		Troubleshooting.....	250
Program.....	565	Traction Control – Information	
The Mediation and Arbitration		Messages.....	250
Program.....	566	Trailer Backup Assistance	
Tire Care.....	461	Precautions.....	386
Tire Pressure Monitoring System		Trailer Backup Assistance.....	386
Limitations.....	466	Setting Up the Trailer Backup Assistance	
Tire Pressure Monitoring System		for a Conventional Trailer.....	386
Overview.....	465	Trailer Backup Assistance –	
Tire Pressure Monitoring System		Troubleshooting.....	394
Precautions.....	466	Trailer Backup Assistance –	
Tire Pressure Monitoring System.....	465	Troubleshooting.....	394
Tire Pressure Monitoring System –		Trailer Backup Assistance – Frequently	
Troubleshooting.....	470	Asked Questions.....	397
Tire Pressure Monitoring System –		Trailer Backup Assistance – Information	
Troubleshooting.....	470	Messages.....	394
Tire Pressure Monitoring System –		Trailer Brake Precautions.....	352
Information Messages.....	471	Trailer Hitching Assistance	
Tire Pressure Monitoring System – Warning		Indicators.....	379
Lamps.....	470	Trailer Hitching Assistance	
Tire Replacement Requirements.....	457	Limitations.....	377
Tire Rotation.....	463	Trailer Hitching Assistance	
Towing a Trailer Limitations.....	353	Precautions.....	377
Towing a Trailer Precautions.....	352	Trailer Hitching Assistance.....	377
Towing a Trailer.....	352	Trailer Lighting Check.....	350
Towing a Trailer – Troubleshooting.....	356	Trailer Reverse Guidance	
Towing Weights and Dimensions.....	354	Precautions.....	401
Towing a Trailer –		Trailer Reverse Guidance.....	401
Troubleshooting.....	356	Setting Up Trailer Reverse Guidance for a	
Towing a Trailer – Information		Conventional Trailer.....	401
Messages.....	356	Trailer Reverse Guidance –	
Towing Weights and Dimensions.....	354	Troubleshooting.....	407
Calculating the Maximum Loaded Trailer		Trailer Reverse Guidance –	
Weight for Your Vehicle.....	355	Troubleshooting.....	407
Recommended Towing Weights.....	354	Trailer Reverse Guidance – Frequently	
What Is the Maximum Loaded Trailer		Asked Questions.....	409
Weight.....	355	Trailer Reverse Guidance – Information	
Towing Your Vehicle.....	425	Messages.....	407
Towing Your Vehicle –		Trailer Reversing Aid Precautions.....	363
Troubleshooting.....	426		

# Index

Trailer Reversing Aid.....	363	Using Smart Hitch - Vehicles With: 15 Inch Screen.....	381
Setting Up the Trailer Reversing Aid for a Conventional Trailer.....	363	Using Snow Chains.....	459
Trailer Reversing Aid - Troubleshooting.....	369	Using the Backup Start Passcode.....	73
Trailer Reversing Aid - Troubleshooting.....	369	Using the Center Console Work Surface.....	190
Trailer Reversing Aid – Information Messages.....	369	Using the Instrument Cluster Display Controls.....	142
Trailer Sway Control Precautions.....	362	Using the Integrated Trailer Brake Controller.....	358
Trailer Sway Control.....	362	Using the Keyless Entry Keypad.....	90
Trailer Towing Hints.....	353	Using the Remote Control.....	67
Trailer Towing Navigation.....	548	Using the Trailer Backup Assistance Controller.....	391
Transferring Power - Vehicles With: 12.3 Inch Screen.....	224	Using the Trailer Backup Assistance Views.....	391
Transferring Power - Vehicles With: 15 Inch Screen.....	224	Using the Trailer Reverse Guidance Views.....	367
Transporting the Vehicle.....	423	Using the Trailer Reversing Aid Controller.....	366
Trip Computer.....	146	Using the Valet Mode.....	73
Trip Data - Vehicles With: 12.3 Inch Screen.....	146	Using This Publication.....	22
Trip Data - Vehicles With: 15 Inch Screen.....	146	Using Trailer Hitching Assistance.....	378
Trip Summary.....	143	Using Trailer Reverse Guidance Views.....	405
<b>U</b>		<b>V</b>	
Under Hood Fuse Box.....	427	Vehicle Care.....	442
Accessing the Under Hood Fuse Box.....	427	Cleaning the Exterior.....	442
Identifying the Fuses in the Under Hood Fuse Box.....	428	Cleaning the Interior.....	444
Locating the Under Hood Fuse Box.....	427	Vehicle Charging Status.....	143
Under Hood Overview.....	436	Vehicle Identification Number.....	484
Updating the Vehicle Systems Wirelessly.....	554	Locating the Vehicle Identification Number.....	484
USB Ports.....	181	Vehicle Identification Number Overview.....	484
Using Alexa Built-In.....	524	Vehicle Identification.....	484
Using a Slide-In Camper.....	329	Vehicle Identification Number.....	484
Using Auto Hold.....	247	Vehicle Interior.....	33
Using FordPass and Charging.....	219	Vehicle Power Down Timer.....	195
Using Keyless Entry.....	88	How Does the Vehicle Power Down Timer Work.....	195
Using On-Board Scale - Vehicles With: 12.3 Inch Screen.....	383	Overriding the Vehicle Power Down Timer.....	195
Using On-Board Scale - Vehicles With: 15 Inch Screen.....	384	Switching the Vehicle Power Down Timer On and Off.....	195
Using Smart Hitch - Vehicles With: 12.3 Inch Screen.....	380		

# Index

What Is the Vehicle Power Down Timer.....	195	What Is a Connected Vehicle.....	485
Vehicle Range Display.....	137	What Is Active Park Assist.....	267
Vehicle System Updates.....	554	What Is Alexa Built-In.....	524
Vehicle Wi-Fi Hotspot – Troubleshooting.....	489	What Is Blind Spot Information System.....	304
Vehicle Wi-Fi Hotspot – Frequently Asked Questions.....	489	What Is BlueCruise.....	288
Vehicle Wi-Fi Hotspot.....	488	What Is Cross Traffic Alert.....	309
Vehicle Wi-Fi Hotspot – Troubleshooting.....	489	What Is Cruise Control.....	271
Ventilated Seats.....	170	What Is DC Charging.....	199
Switching the Ventilated Seats On and Off.....	170	What Is Drive Mode Control.....	294
Ventilated Seat Precautions.....	170	What Is Drive Alert.....	322
Ventilation		What Is Ford Protect.....	559
See: Climate Control - Vehicles With: 12.3 Inch Screen.....	150	What Is Hill Start Assist.....	246
See: Climate Control - Vehicles With: 15 Inch Screen.....	155	What Is Intelligent Backup Power.....	222
Venting the Moonroof.....	135	What Is MyKey.....	76
Viewing the Tire Pressures.....	467	What Is On-Board Scale.....	383
Visual Search.....	30	What Is One Pedal Drive.....	296
Voice Interaction Examples.....	518	What Is Phone as a Key.....	72
Voice Interaction.....	518	What Is Pre-Collision Assist.....	312
		What Is Remote Start.....	148
		What Is Reverse Braking Assist.....	242
		What Is Smart Hitch.....	380
		What Is Speed Sign Recognition.....	324
		What Is the 360 Degree Camera.....	263
		What Is the Cabin Air Filter.....	161
		What Is the Electric Parking Brake.....	239
		What Is the Electronic Locking Differential.....	233
		What Is the Gross Axle Weight Rating.....	329
		What Is the Gross Combined Weight Rating.....	329
		What Is the Gross Vehicle Weight Rating.....	329
		What Is the High Voltage Battery.....	197
		What Is the Integrated Trailer Brake Controller.....	358
		What Is the Keyless Entry Keypad.....	89
		What Is the Lane Keeping System.....	297
		What Is the Memory Function.....	176
		What Is the Onboard Generator.....	184
		What Is the Pedestrian Alert System.....	64
		What Is the Personal Safety System.....	54
		What Is the Power Outlet.....	183
		What Is the Rear Occupant Alert System.....	174

## W

Washer Fluid Specification.....	482
Washers.....	112
Adding Washer Fluid.....	113
Switching the Courtesy Wipe On and Off.....	112
Using the Windshield Washer.....	112
Washer Fluid Specification.....	113
Washer Precautions.....	112
Washers	
See: Wipers and Washers.....	110
Waxing Your Vehicle.....	447
Waypoints.....	547
Adding a Waypoint.....	547
Editing Waypoints.....	547
What Are the Instrument Cluster Indicators.....	140
What Are the Instrument Cluster Warning Lamps.....	138
What Is 911 Assist.....	65
What Is AC Charging.....	199

# Index

---

What Is the Rear View Camera.....	260	Wiper Precautions.....	110
What Is the Tire Pressure Monitoring System.....	465	Wireless Accessory Charger Precautions.....	191
What Is the Trailer Reversing Aid.....	363	Wireless Accessory Charger.....	191
What Is the Wireless Accessory Charger.....	191		
What Is Traction Control.....	249		
What is Trailer Backup Assistance.....	386		
What Is Trailer Hitching Assistance.....	377		
What Is Trailer Reverse Guidance.....	401		
What is Voice Interaction.....	518		
Wheel and Tire Information.....	450		
Wheel Nuts.....	479		
Wi Fi			
See: Changing the Vehicle Wi-Fi Hotspot Name or Password.....	488		
See: Connecting the Vehicle to a Wi-Fi Network - Vehicles With: 12.3 Inch Screen.....	486		
See: Connecting the Vehicle to a Wi-Fi Network - Vehicles With: 15 Inch Screen.....	486		
See: Creating a Vehicle Wi-Fi Hotspot.....	488		
See: Vehicle Wi-Fi Hotspot - Vehicles With: 12.3 Inch Screen.....	488		
See: Vehicle Wi-Fi Hotspot - Vehicles With: 15 Inch Screen.....	490		
Window Bounce-Back.....	129		
Overriding Window Bounce-Back.....	129		
What Is Window Bounce-Back.....	129		
Windows.....	129		
Window Bounce-Back.....	129		
Wipers and Washers – Troubleshooting.....	113		
Wipers and Washers – Frequently Asked Questions.....	113		
Wipers and Washers – Warning Lamps.....	113		
Wipers and Washers.....	110		
Autowipers.....	110		
Washers.....	112		
Wipers.....	110		
Wipers and Washers – Troubleshooting.....	113		
Wipers.....	110		
Switching Windshield Wipers On and Off.....	110		





